

MC909X Mobile Computer

User Guide

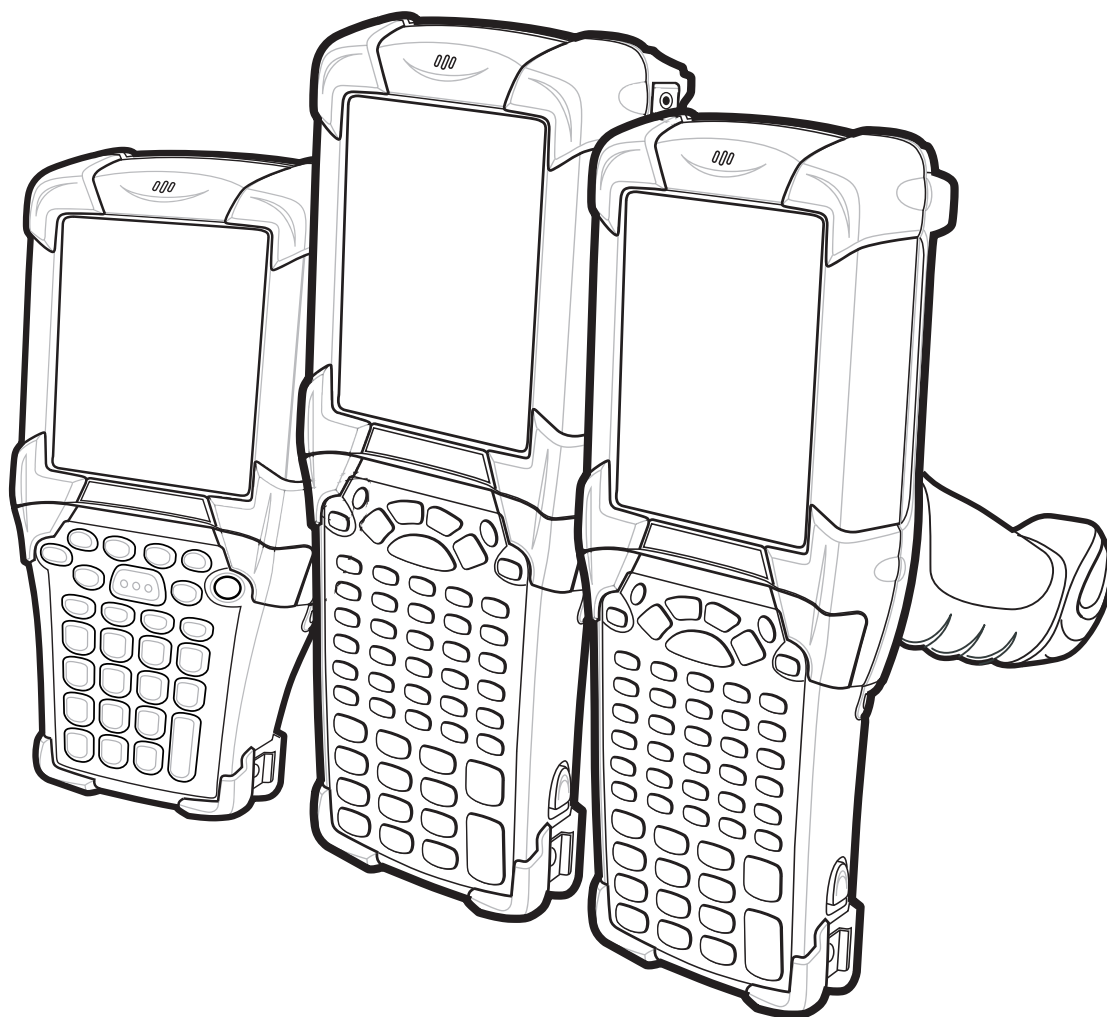

MC909X User Guide

72E-72215-07

Rev A

April 2015

© 2015 ZIH Corp

No part of this publication may be reproduced or used in any form, or by any electrical or mechanical means, without permission in writing from Zebra. This includes electronic or mechanical means, such as photocopying, recording, or information storage and retrieval systems. The material in this manual is subject to change without notice.

The software is provided strictly on an “as is” basis. All software, including firmware, furnished to the user is on a licensed basis. Zebra grants to the user a non-transferable and non-exclusive license to use each software or firmware program delivered hereunder (licensed program). Except as noted below, such license may not be assigned, sublicensed, or otherwise transferred by the user without prior written consent of Zebra. No right to copy a licensed program in whole or in part is granted, except as permitted under copyright law. The user shall not modify, merge, or incorporate any form or portion of a licensed program with other program material, create a derivative work from a licensed program, or use a licensed program in a network without written permission from Zebra. The user agrees to maintain Zebra’s copyright notice on the licensed programs delivered hereunder, and to include the same on any authorized copies it makes, in whole or in part. The user agrees not to decompile, disassemble, decode, or reverse engineer any licensed program delivered to the user or any portion thereof.

Zebra reserves the right to make changes to any software or product to improve reliability, function, or design.

Zebra does not assume any product liability arising out of, or in connection with, the application or use of any product, circuit, or application described herein.

No license is granted, either expressly or by implication, estoppel, or otherwise under any Zebra, intellectual property rights. An implied license only exists for equipment, circuits, and subsystems contained in Zebra products.

Revision History

Changes to the original manual are listed below:

Change	Date	Description
Rev A	11/1/05	Initial release.
-02 Rev A	1/19/06	Add MC9090-K/S, MC9090-G and MC9094-K/S with Windows Mobile 5.0.
-03 Rev A	3/21/06	Add MC9097 support.
-04 Rev A	3/6/07	Add generic MC9097 information, 33-key keypad, Fusion 2.5 and AKU 3.2 update information.
-05 Rev A	9/15/07	Guide re-branding, incorporate Mobile OEM version 01.39.0001 and CE OEM version 01.26.0001 and add support for Haz Loc configurations.
-07 Rev A	4/8/2015	Zebra re-branding.

Table of Contents

Revision History	iii
About This Guide	
Introduction	v
Documentation Set	v
Configurations	vi
Software Versions	vii
Chapter Descriptions	x
Notational Conventions	xi
Related Documents and Software	xi
Service Information	xii
Chapter 1: Getting Started	
Introduction	1-1
Unpacking the Mobile Computer	1-4
Accessories	1-4
Getting Started	1-6
Installing and Removing the Main Battery	1-6
Installing the Main Battery	1-6
Charging the Battery	1-7
Charging the Main Battery and Memory Backup Battery	1-7
Charging Spare Batteries	1-8
Removing the Main Battery	1-8
Starting the Mobile Computer	1-10
Calibrating the Screen	1-10
Checking Battery Status	1-10
SIM Card	1-11
Stylus	1-13
MC9090-G Strap	1-14
MC909X-K Strap	1-15
MC909X-S Strap	1-16

Battery Management	1-17
Battery Saving Tips	1-17
Changing the Power Settings	1-17
Changing the Display Backlight Settings	1-17
Changing the Keypad Backlight Settings	1-18
Turning Off the Radios	1-18
On Devices with Mobile 5.0 AKU 1.0	1-18
Turning Off the WLAN Radio	1-18
Bluetooth and WWAN Radios	1-19
On Devices with Mobile 5.0 AKU 2.2 and higher	1-19
On Device with CE 5.0 (OEM Version 01.15 and lower)	1-20
WLAN Radio	1-20
Bluetooth Radio	1-21
On Device with CE 5.0 (OEM Version 01.16 and higher)	1-21
WLAN Radio	1-21
Bluetooth Radio	1-21

Chapter 2: Operating the MC909X

Introduction	2-1
Status Icons (Windows CE 5.0)	2-1
Status Icons (Windows Mobile 5.0)	2-3
Status Bar	2-3
Command Bar	2-4
Speaker Icon	2-5
Battery Icon	2-6
Connectivity Icon	2-6
Time Icon	2-7
Instant Message Icon	2-7
E-Mail Icon	2-7
Multiple Notification Icon	2-8
Locking the Mobile Computer (Windows Mobile 5.0 Only)	2-8
LED Indicators	2-9
Keypads	2-10
28-Key Keypad for MC909X-G/K	2-11
28-Key Keypad for MC909X-S	2-12
33-Key Numeric/Function Keypad for MC909X-K	2-16
38-Key Numeric/Function Keypad for MC909X-S	2-20
38-Key Alpha/Shifted Numeric Keypad for MC909X-S	2-24
43-Key Keypad for MC909X-G/K	2-27
53-Key Keypad for MC909X-G/K	2-31
3270 Emulator Keypad for MC909X-G/K	2-34
5250 Emulator Keypad for MC909X-G/K	2-37
VT Emulator Keypad	2-40
Keypad Special Functions	2-43
Entering Data	2-44
Using the Power Button	2-44
Using a Wired Headset	2-45
Using a Bluetooth Headset	2-46
Data Capture	2-46

Laser Scanning	2-46
Imaging	2-46
Scanning Considerations	2-47
Scanning Bar Codes	2-48
Scan LED Indicator	2-49
Resetting the Mobile Computer	2-49
Windows CE 5.0 Devices	2-49
Performing a Warm Boot	2-49
Performing a Cold Boot	2-50
Windows Mobile 5.0 Devices	2-50
Performing a Warm Boot	2-50
Performing a Cold Boot	2-50
Waking the Mobile Computer	2-51

Chapter 3: Using Bluetooth

Introduction	3-1
Adaptive Frequency Hopping	3-1
Security	3-2
Turning the Bluetooth Radio Mode On and Off	3-2
Disabling Bluetooth	3-2
Enabling Bluetooth	3-3
Bluetooth Power States	3-3
Cold Boot	3-3
Warm Boot	3-3
Suspend	3-4
Resume	3-4
Bluetooth Profiles	3-4
Modes	3-5
Wizard Mode	3-5
Explorer Mode	3-7
Discovering Bluetooth Device(s)	3-8
Bonding with Discovered Device(s)	3-9
Renaming a Bonded Device	3-11
Deleting a Bonded Device	3-11
Accepting a Bond	3-12
Discovering Services	3-13
File Transfer Services	3-14
Create New File or Folder	3-14
Delete File	3-15
Get File	3-15
Put File	3-15
Connect to Internet Using Access Point	3-15
Dial-Up Networking Services	3-15
Add a Dial-up Entry	3-17
OBEX Object Push Services	3-18
Send a Picture	3-18
Headset Services	3-19
Serial Port Services	3-20
Personal Area Network Services	3-21

IrMC Synchronization Services	3-21
Bluetooth Settings	3-22
Device Info Tab	3-22
Services Tab	3-22
Dial-Up Networking Service	3-23
File Transfer Service	3-24
OBEX Object Push Service	3-25
Personal Area Networking Service	3-25
Serial Port Service	3-26
Headset Service	3-27
IrMC Synchronization Service	3-27
Security Tab	3-28
Discovery Tab	3-28
Virtual COM Port Tab	3-29
Miscellaneous Tab	3-30

Chapter 4: Using MC9094 Phone

Introduction	4-1
Accessing the Phone Keypad	4-1
Making a Call Using the Keypad	4-2
Answering a Call	4-2
Audio Modes	4-3
Incoming Call Features	4-3
Muting a Call	4-4
Taking Notes	4-4
Using Speed Dial	4-5
Adding a Speed Dial Entry	4-5
Editing a Speed Dial Entry	4-8
Deleting a Speed Dial Entry	4-8
Making a Speed Dial Call	4-9
Using Call History	4-10
Managing Call History	4-10
Changing the Call History View	4-10
Resetting the Recent Calls Counter	4-11
Deleting Call History Items by Call Date	4-12
Deleting All Call History Items	4-12
Viewing Call Status	4-13
Using the Call History Menu	4-14
Using Contacts	4-14
Swapping Calls	4-15
Conference Calling	4-16
Text Messaging	4-17
Sending a Message	4-17
Establishing a Data Connection	4-18
Ending an GPRS Data Connection	4-20

Chapter 5: Using the MC9097 Phone

Introduction	5-1
--------------------	-----

Getting Started	5-1
Activating Service	5-1
Phone Properties Page	5-1
Finding Your Phone Number and Walkie-Talkie Number	5-1
Accessing the Phone Keypad	5-3
Turning the Phone On and Off	5-3
With AKU 1.1 (Flight Mode)	5-3
With AKU 2.2 and Higher	5-4
Using the Speakerphone and a Headset	5-6
Adjusting Audio Volume	5-6
Making a Phone Call	5-7
Using the Phone Keypad	5-7
Making Calls from Contacts	5-7
Making Calls from Recent Call List	5-8
Receiving Phone Calls	5-9
Walkie-Talkie Calls	5-10
Optimum Walkie-Talkie Usage	5-10
Sending Call Alerts	5-11
Making Walkie-Talkie Calls	5-12
Making Walkie-Talkie Calls from Contacts	5-12
Receiving Call Alerts	5-13
Receiving Walkie-Talkie Calls	5-14
Establishing a Data Packet Connection	5-15
Phone Options	5-16
Creating Notes	5-16
Muting a Call	5-18
Putting Calls on Hold	5-18
Using Speed Dial	5-18
Add a Speed Dial Entry	5-19
Create a New Speed Dial Entry	5-20
Edit a Speed Dial Entry	5-20
Delete a Speed Dial Entry	5-21
Viewing Missed Calls	5-21
Viewing Call History	5-22
View Call History by Call Type	5-22
Viewing Call Status	5-23
Deleting Calls	5-23
Deleting Calls Based on Length of Time	5-24
Deleting individual Calls	5-24
Using Call Timers	5-25

Chapter 6: Accessories

Introduction	6-1
Keypads	6-1
Cradles	6-1
Snap-on Modules	6-1
Keypads	6-2
Replacing the Keypad	6-2
Multi Media Card (MMC) / Secure Device (SD) Card	6-3

Single Slot Serial/USB Cradle	6-5
Battery Charging Indicators	6-6
Four Slot Ethernet Cradle	6-7
Battery Charging Indicators	6-8
Four Slot Charge Only Cradle	6-9
Battery Charging Indicators	6-10
Four Slot Spare Battery Charger	6-10
Spare Battery Charging with the Four Slot Spare Battery Charger	6-10
Battery Charging Indicators	6-10
Magnetic Stripe Reader	6-11
Attaching and Removing	6-12
Setup	6-13
Battery Charging Indicators	6-13
Serial/USB Connection	6-13
Using the MSR	6-14
Cable Adapter Module	6-15
Attaching and Removing	6-15
Setup	6-16
Battery Charging Indicators	6-17
Serial/USB Connection	6-17
Universal Battery Charger (UBC) Adapter	6-18
Inserting and Removing a Battery	6-18
Battery Charging Indicators	6-18
Modem Module	6-20
Setup	6-21
Connecting to the Mobile Computer	6-21
Connecting to the Single Slot Serial/USB Cradle	6-22

Chapter 7: Maintenance & Troubleshooting

Introduction	7-1
Maintaining the Mobile Computer	7-1
Battery Safety Guidelines	7-1
Troubleshooting	7-3
Mobile Computer	7-3
Bluetooth Connection	7-5
Four Slot Charge Only Cradle	7-6
Four Slot Ethernet Cradle	7-7
Single Slot Serial/USB Cradle	7-10
Cable Adapter Module	7-11
Magnetic Stripe Reader	7-11
Modem Module	7-13

Appendix A: Specifications

Technical Specifications	A-1
Mobile Computer	A-1
Modem Module	A-6
Mobile Computer Pin-Outs	A-8
Accessory CAM and MSR Pin-Outs	A-9

Non-Incendive Devices A-10

Appendix B: Keypad Special Keys

Introduction B-1
 Keypads B-1

Appendix C: Regulatory

Introduction C-1
 Accessory Power Supply Regulatory Compliance C-1

Glossary

Index

About This Guide

Introduction

This guide provides information about using the MC9090 family of mobile computers and accessories.

✓ **NOTE** Screens and windows pictured in this guide are samples and can differ from actual screens.

Documentation Set

The documentation set for the MC909X is divided into guides that provide information for specific user needs.

- **Microsoft Application Guide** - describes how to use Microsoft developed applications.
- **Application Guide** - describes how to use Zebra developed applications.
- **MC909X User Guide** - describes how to use the MC909X mobile computer.
- **MC909X Integrator Guide** - describes how to set up the MC909X mobile computer and the accessories.
- **SMDK Help File** - provides API information for writing applications.

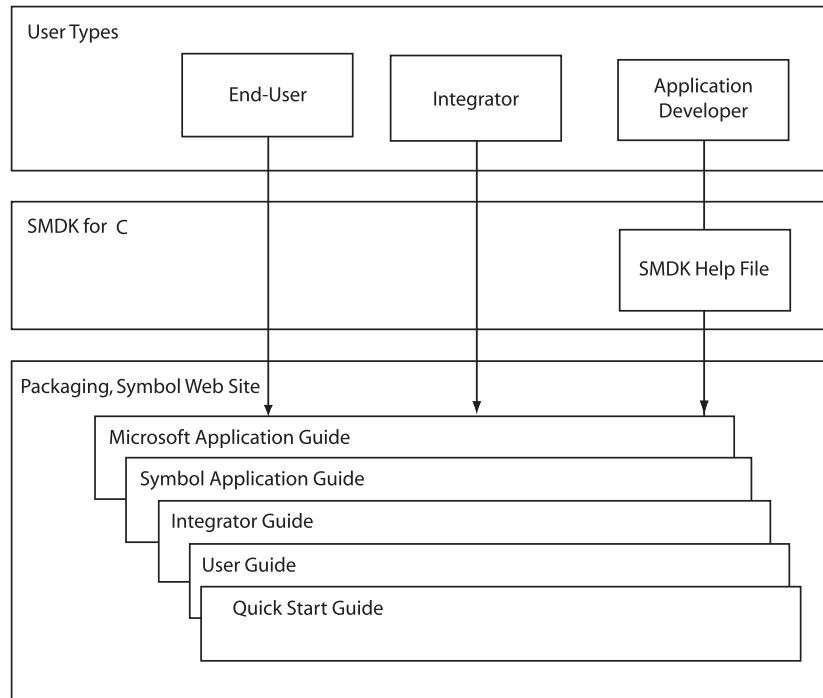

Configurations

This guide covers the following configurations:

Configuration	Radios	Display	Memory	Data Capture	Operating System	Keypads	Other
MC9090-G	WLAN: 802.11a/b/g WPAN: Bluetooth	Color or monochrome	64 MB RAM or 128 MB RAM/ 64 MB Flash	Laser, Long Range Laser, or Imager	Windows CE 5.0	28-key, 43-key, 53-key, VT, 3270, 5250 Emulators	Haz Loc Class 1 Div 2 Condensation Resistant ¹
MC9090-G	WLAN: 802.11a/b/g WPAN: Bluetooth	Color	64 MB RAM or 128 MB RAM/ 128 MB Flash	Laser, Long Range Laser, or Imager	Windows Mobile 5.0 Premium Edition	28-key, 43-key, 53-key, VT, 3270, 5250 Emulators	Haz Loc Class 1 Div 2 Condensation Resistant ¹
MC9090-K	WLAN: 802.11a/b/g WPAN: Bluetooth	Color	64 MB RAM or 128 MB RAM/ 128 MB Flash	Laser or Imager	Windows Mobile 5.0 Premium Edition	28-key, 33-key, 43-key, 53-key	Haz Loc Class 1 Div 2
MC9090-S	WLAN: 802.11a/b/g WPAN: Bluetooth	Color	64 MB RAM or 128 MB RAM/ 128 MB Flash	Laser or Imager	Windows Mobile 5.0 Premium Edition	28-key, 38-key alpha, 38-key numeric	

¹ Condensation Resistant configurations utilize desiccant located inside the mobile computer to capture internal moisture that forms when they are carried from a warm humid environment to a cold environment.

Configuration	Radios	Display	Memory	Data Capture	Operating System	Keypads	Other
MC9094-K	WLAN 802.11a/b/g WPAN: Bluetooth WWAN:EDGE/ GPRS	Color	64 MB RAM or 128 MB RAM/ 128 MB Flash	Laser or Imager	Windows Mobile 5.0 Phone Edition	28-key, 33-key, 43-key, 53-key	
MC9094-S	WLAN 802.11a/b/g WPAN: Bluetooth WWAN:EDGE/ GPRS	Color	64 MB RAM or 128 MB RAM/ 128 MB Flash	Laser or Imager	Windows Mobile 5.0 Phone Edition	28-key, 38-key alpha, 38-key numeric	
MC9097-K	WLAN 802.11a/b/g WPAN: Bluetooth WWAN: iDEN	Color	64 MB RAM or 128 MB RAM/ 128 MB Flash	Laser or Imager	Windows Mobile 5.0 Phone Edition	28-key, 33-key, 43-key, 53-key	
MC9097-S	WLAN 802.11a/b/g WPAN: Bluetooth WWAN: iDEN	Color	64 MB RAM or 128 MB RAM/ 128 MB Flash	Laser or Imager	Windows Mobile 5.0 Phone Edition	28-key, 38-key alpha, 38-key numeric	

¹ Condensation Resistant configurations utilize desiccant located inside the mobile computer to capture internal moisture that forms when they are carried from a warm humid environment to a cold environment.

Software Versions

This guide covers various software configurations and references are made to operating system or software versions for:

- Adaptation Kit Update (AKU) version
- OEM version
- Phone version
- BTExplorer version
- Fusion version
- Phone version.

AKU Version for Mobile 5.0 Devices

To determine the Adaptation Kit Update (AKU) version on a Mobile 5.0 device:

Tap **Start > Settings > System tab > About icon > Version tab.**

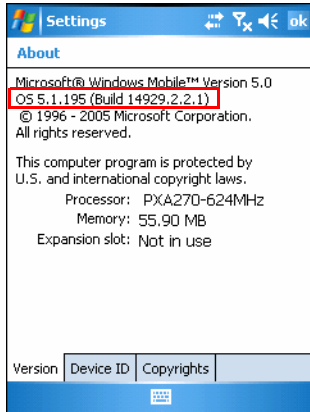

The second line lists the operating system version and the build number. The last part of the build number represents the AKU number. For example, *Build 14929.2.2.1* indicates that the device is running AKU version 2.2.1.

OEM Version on Mobile 5.0 Devices

To determine the OEM software version on a Mobile 5.0 device:

Tap **Start** > **Settings** > **System** tab > **System Information** icon > **System** tab.

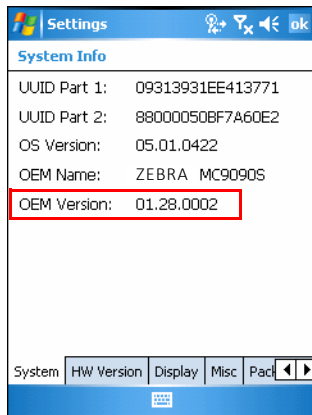

OEM Software on Windows CE 5.0 Devices

To determine the OEM software version on a CE 5.0 device:

Tap **Start** > **Settings** > **Control Panel** > **System Information** icon > **System** tab.

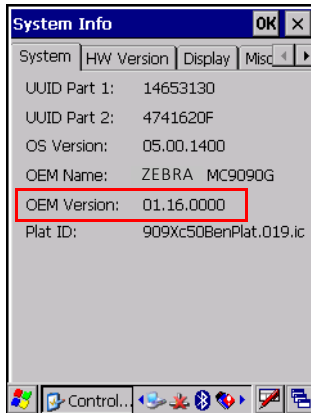

BTE Explorer Software

To determine the BTE Explorer software version on a Mobile 5.0 or Windows CE 5.0 device:

Tap **BTE Explorer** icon > **Show BTE Explorer**> **File** > **About**.



Fusion Software

To determine the Fusion software version on a Mobile 5.0 or Windows CE 5.0 device:

Tap **Wireless Strength** icon > **Wireless Status** > **Versions**.

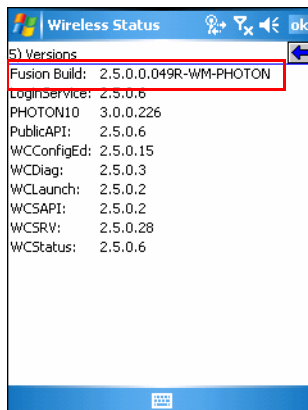

Phone Software

To determine the Phone software version on a Mobile 5.0 device:

Tap **Start > Phone > Menu > Options > Version Information** tab.



MC9094

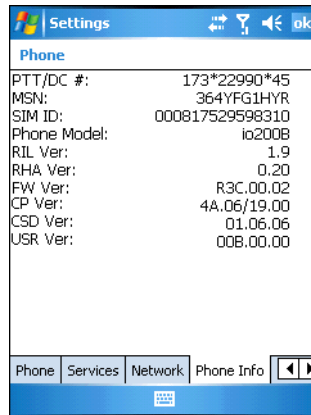

MC9097

Chapter Descriptions

Topics covered in this guide are as follows:

- [Chapter 1, Getting Started](#), provides information on getting the mobile computer up and running for the first time.
- [Chapter 2, Operating the MC909X](#), explains how to use the mobile computer. This includes instructions for powering on and resetting the mobile computer, entering and capturing data.
- [Chapter 3, Using Bluetooth](#), explains how to perform Bluetooth functionality on the mobile computer.
- [Chapter 4, Using MC9094 Phone](#), explains how to use the MC9094 phone functionality on the mobile computer.
- [Chapter 5, Using the MC9097 Phone](#), explains how to use the MC9097 phone functionality on the mobile computer.
- [Chapter 6, Accessories](#), describes the accessories available for the mobile computer and how to use the accessories with the mobile computer.
- [Chapter 7, Maintenance & Troubleshooting](#), includes instructions on cleaning and storing the mobile computer, and provides troubleshooting solutions for potential problems during mobile computer operation.
- [Appendix A, Specifications](#), includes a table listing the technical specifications for the mobile computer.
- [Appendix B, Keypad Special Keys](#), contains the keypad functions/special characters for the keypads. includes a table listing the technical specifications for the mobile computer.
- [Appendix C, Regulatory](#), contains the accessory power supply regulatory compliance statements.

Notational Conventions

The following conventions are used in this document:

- “Mobile computer” refers to the Zebra MC909X series of hand-held computers.
- *Italics* are used to highlight the following:
 - Chapters and sections in this guide
 - Related documents
- **Bold** text is used to highlight the following:
 - Dialog box, window and screen names
 - Drop-down list and list box names
 - Check box and radio button names
 - Icons on a screen
 - Key names on a keypad
 - Button names on a screen.
- Bullets (•) indicate:
 - Action items
 - Lists of alternatives
 - Lists of required steps that are not necessarily sequential.
- Sequential lists (e.g., those that describe step-by-step procedures) appear as numbered lists.

Related Documents and Software

The following documents provide more information about the MC909X mobile computers.

- *MC9090-G Quick Start Guide*, p/n 72-72217-xx
- *MC909X-K/S Quick Start Guide*, p/n 72-72220-xx
- *MC9090-G Windows® Mobile® 5.0 Regulatory Guide*, p/n 72-72219-xx
- *MC9090-G Windows® CE 5.0 Regulatory Guide*, p/n 72-72218-xx
- *MC909X-K/S Windows® Mobile® 5.0 Regulatory Guide*, p/n 72-73446-xx
- *MC909X Integrator Guide*, p/n 72E-72216-xx
- *Application Guide for Zebra Devices*, p/n 72E-68901-xx
- *Microsoft Applications for Windows Mobile and CE 5.0 User Guide*, p/n 72E-78456-xx
- *Symbol Mobility Developer Kit (SMDK) Help File*, p/n 72E-38880-03
- *Symbol Mobility Developer Kits*, available at: <http://www.zebra.com/support>
- Device Configuration Package (DCP for MC9090c50) and Platform SDK (PSDK9090c50) for MC9090-G with Windows CE 5.0, available at: <http://www.zebra.com/support>.
- ActiveSync software, available at: <http://www.microsoft.com>.

For the latest version of this guide and all guides, go to: <http://www.zebra.com/support>.

Service Information

If you have a problem with your equipment, contact Zebra support for your region. Contact information is available at: <http://www.zebra.com/support>.

When contacting Zebra support, please have the following information available:

- Serial number of the unit
- Model number or product name
- Software type and version number.

Zebra responds to calls by email, telephone or fax within the time limits set forth in support agreements.

If your problem cannot be solved by Zebra Support, you may need to return your equipment for servicing and will be given specific directions. Zebra is not responsible for any damages incurred during shipment if the approved shipping container is not used. Shipping the units improperly can possibly void the warranty.

If you purchased your business product from a Zebra business partner, contact that business partner for support.

Chapter 1 Getting Started

Introduction

This chapter lists the accessories for the mobile computer and explains how to install and charge the batteries, replace the strap and start the mobile computer for the first time.

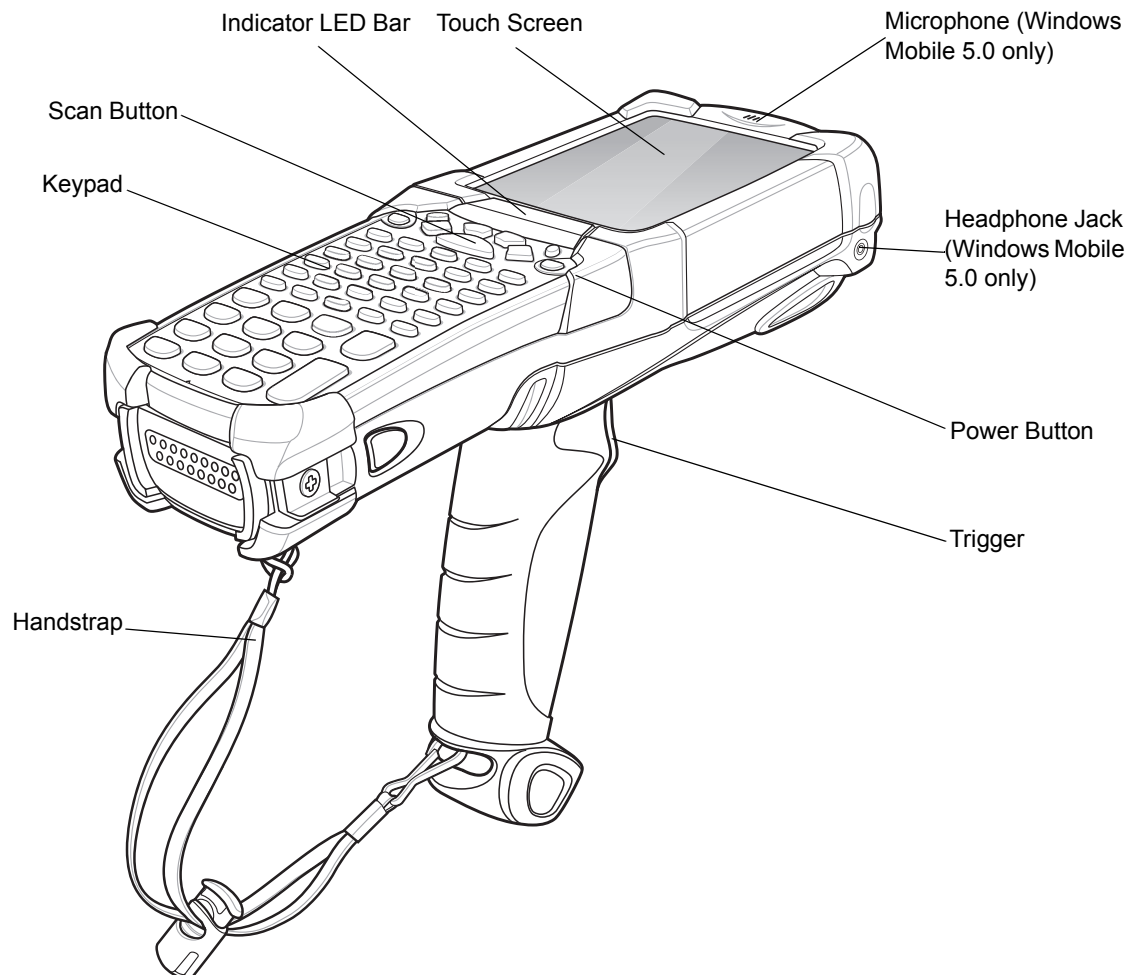

Figure 1-1 MC9090-G

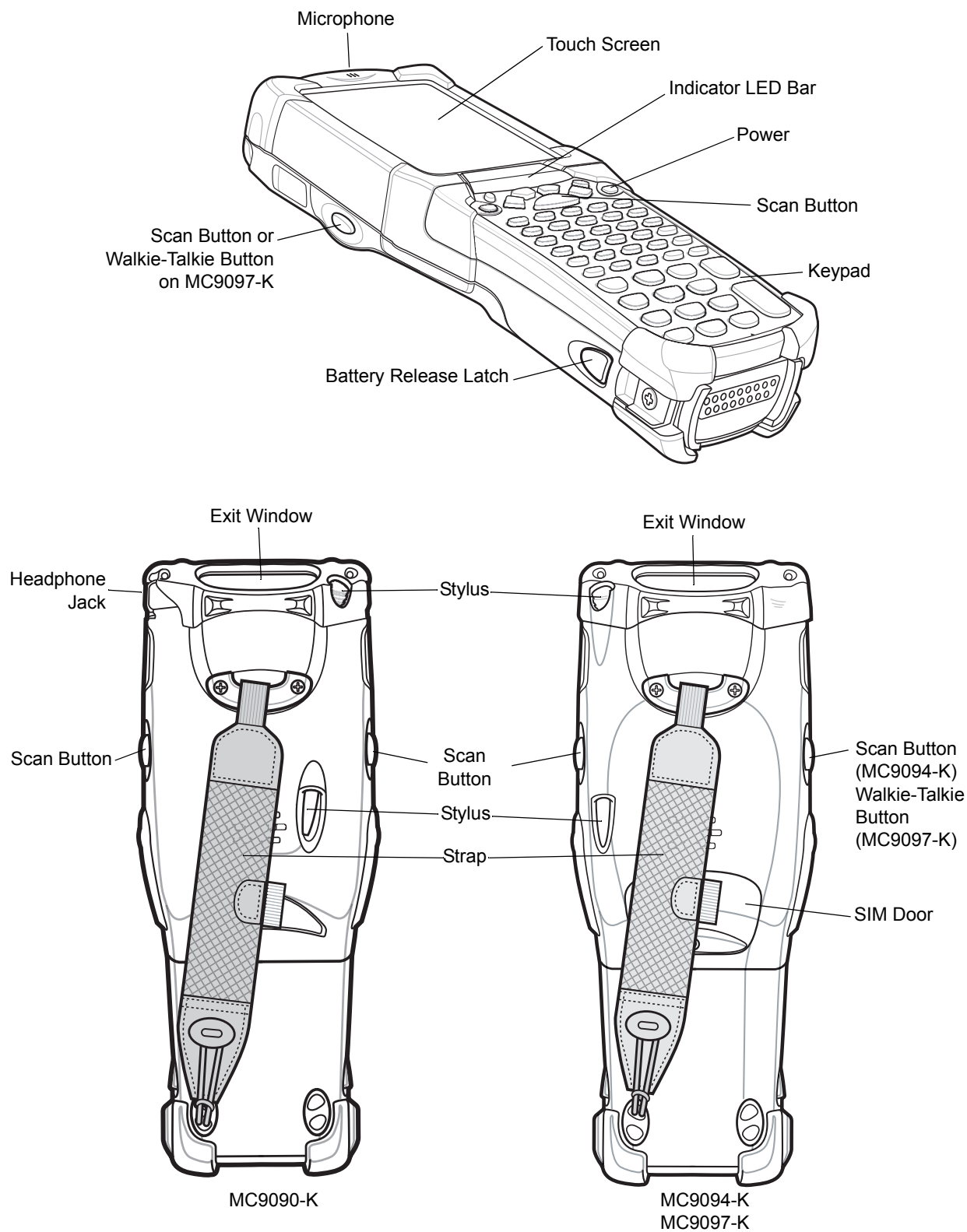

Figure 1-2 MC909X-K

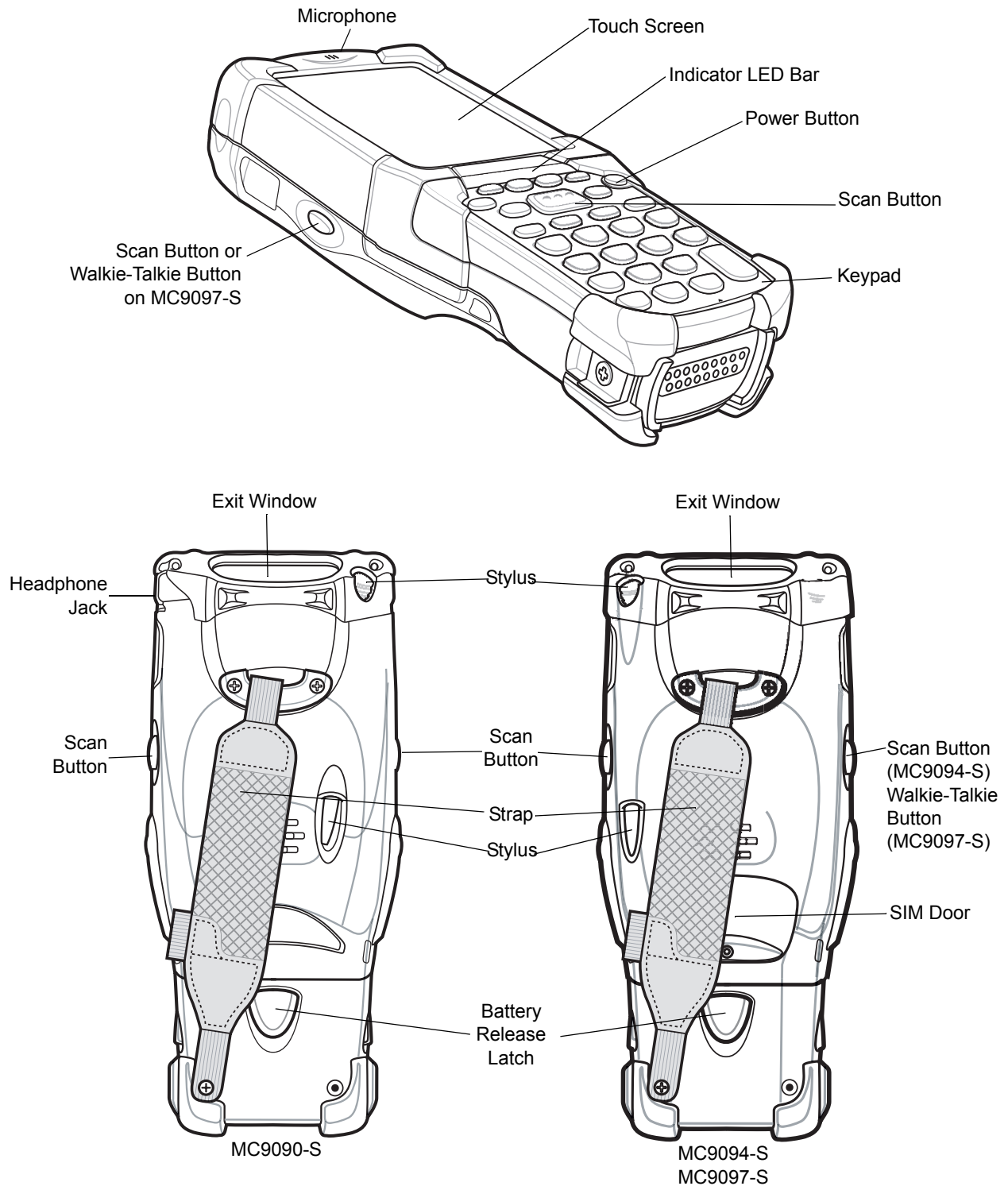

Figure 1-3 MC909X-S

Unpacking the Mobile Computer

Carefully remove all protective material from around the mobile computer and save the shipping container for later storage and shipping.

Verify that you received all equipment listed below:

- mobile computer
- lithium-ion battery
- strap, attached to the mobile computer
- stylus, in the stylus silo
- Regulatory Guide
- Quick Start Guide (poster).

Inspect the equipment for damage. If you are missing any equipment or if you find any damaged equipment, contact the Zebra Global Interactive Center immediately. See [page xii](#) for contact information.

Accessories

[Table 1-1](#) lists the accessories available for the MC909X:

Table 1-1 MC909X Accessories

Accessory	Description
Cable Adapter Module (CAM)	Snap-on required to connect the following cables to the mobile computer. AC line cord (country-specific) and power supply, charges the mobile computer. Auto charge cable, charges the mobile computer using a vehicle's cigarette lighter. DEX cable, connects the mobile computer to a vending machine. Serial cable, adds serial communication capabilities. USB cable, adds USB communication capabilities. Printer cable, adds printer communication capabilities.
Four Slot Charge Only Cradle	Charges the mobile computer main battery.
Four Slot Ethernet Cradle	Charges the mobile computer main battery and synchronizes the mobile computer with a host computer through an Ethernet connection.
Four Slot Spare Battery Charger	Charges up to four mobile computer spare batteries.
Headphone	Use in noisy environments.
Holster	Holds the mobile computer when not in use.
Keypads (Optional)	Application specific keypads.
Magnetic Stripe Reader (MSR)	Snaps on to the mobile computer and adds magstripe read capabilities.

Table 1-1 MC909X Accessories

Accessory	Description
Modem Module	Enables data communication between the mobile computer and a host computer, remotely through the phone lines, and synchronizes information between the mobile computer and a host computer.
Storage Card	Provides secondary non-volatile storage.
Single Slot Serial/USB Cradle	Charges the mobile computer main battery and a spare battery. It also synchronizes the mobile computer with a host computer through either a serial or a USB connection.
Software	<i>Symbol Mobility Developer Kits</i> available at: http://www.zebra.com/support .
	Device Configuration Package (DCPforMC9090c50) and Platform SDK (PSDK9090c50) for MC9090-G with Windows CE 5.0 only, available at: http://www.zebra.com/support .
Spare lithium-ion battery	Replacement battery.
Stylus	Performs pen functions.
Universal Battery Charger Adapter	Adapts the UBC for use with the Series 9000 batteries.
Wall Mounting Bracket and Shelf Slide	Use for wall mounting applications.

Getting Started

In order to start using the mobile computer for the first time:

- install the main battery
- charge the main battery and backup battery
- start the mobile computer
- configure the mobile computer.

The main battery can be charged before or after it is installed. Use one of the spare battery chargers to charge the main battery (out of the mobile computer), or one of the cradles to charge the main battery installed in the mobile computer.

Installing and Removing the Main Battery

Installing the Main Battery

Before using the mobile computer, install a lithium-ion battery by sliding the battery into the mobile computer as shown in [Figure 1-4](#).

- ✓ **NOTE** Ensure the battery is fully inserted. Two audible clicks can be heard as the battery is fully inserted. A partially inserted battery may result in unintentional data loss.

When a battery is fully inserted in a mobile computer for the first time, upon the mobile computer's first power up, the device boots and powers on automatically.

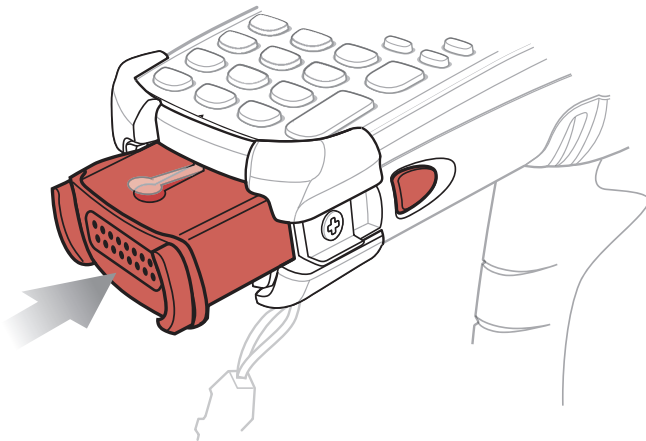

Figure 1-4 *Installing the Main Battery*

Charging the Battery



CAUTION Ensure that you follow the guidelines for battery safety described in [Battery Safety Guidelines on page 7-1](#).

Charging the Main Battery and Memory Backup Battery

Before using the mobile computer for the first time, charge the main battery until the amber charge indicator light remains lit (see [Table 1-2 on page 1-8](#) for charge status indications). The main battery fully charges in less than four hours. The mobile computer can be charged using a cradle, the CAM, or the MSR with the appropriate power supply.

The mobile computer is also equipped with a memory backup battery which automatically charges from the main battery whether or not the mobile computer is operating or is in suspend mode. The memory backup battery retains data in memory for at least 30 minutes when the mobile computer's main battery is removed or fully discharged. When the mobile computer is used for the first time or after the memory backup battery has fully discharged, the memory backup battery requires approximately 15 hours to fully charge. Do not remove the main battery from the mobile computer for 15 hours to ensure that the memory backup battery fully charges. If the main battery is removed from the mobile computer or the main battery is fully discharged, the memory backup battery completely discharges in several hours.

When the main battery reaches a very low battery state, the combination of main battery and backup battery retains data in memory for at least 72 hours.



NOTE Do not remove the main battery within the first 15 hours of use. If the main battery is removed before the backup battery is fully charged, data may be lost.

Use the following to charge batteries:

- Cradles: The mobile computer slips into the cradles for charging the battery in the mobile computer (and spare batteries, where applicable). For detailed cradle setup and charging procedures refer to the *MC909X Integrator Guide*.
 - Single Slot Serial/USB Cradle.
 - Four Slot Ethernet Cradle
 - Four Slot Charge Only Cradle.
- Accessories: The mobile computer snap-on accessories provide charging capability, when used with one of the accessory charging cables. For detailed snap-on setup and charging procedures refer to the *MC909X Integrator Guide*.
 - CAM
 - MSR.
- Chargers: The mobile computer spare battery charging accessories are used to charge batteries that are removed from the mobile computer. For detailed spare battery charging accessories setup and charging procedures refer to the *MC909X Integrator Guide*.
 - Single Slot Serial/USB Cradle
 - Four Slot Spare Battery Charger
 - Universal Battery Charger (UBC) Adapter.



NOTE To achieve the best battery life in mobile computers with multiple radios, turn off the radios that are not being used. See [Turning Off the Radios on page 1-18](#) for more information.

To charge the main battery:

1. Ensure the accessory used to charge the main battery is connected to the appropriate power source.
2. Insert the mobile computer into a cradle or attach the appropriate snap-on module.
3. The mobile computer starts to charge automatically. The amber charge LED, in the Indicator LED Bar, lights to indicate the charge status. See [Table 1-2](#) for charging indications.

The main battery usually fully charges in less than four hours.

Table 1-2 *Mobile Computer LED Charge Indicators*

LED	Indication
Off	Mobile computer not in cradle or connected to a CAM or MSR. Mobile computer not placed correctly. Charger is not powered.
Fast Blinking Amber	Error in charging; check placement of the mobile computer.
Slow Blinking Amber	Mobile computer is charging.
Solid Amber	Charging complete. Note: When the battery is initially inserted in the mobile computer, the amber LED flashes once if the battery power is low or the battery is not fully inserted.

Charging Spare Batteries

Use the following three accessories to charge spare batteries:

- Single Slot Serial/USB Cradle
- Four Slot Spare Battery Charger
- UBC Adapter.

To charge a spare battery:

1. Ensure the accessory used to charge the spare battery is connected to the appropriate power source.
2. Insert the spare battery into the accessory's spare battery charging slot with the charging contacts facing down (over the charging pins) and gently press down on the battery to ensure proper contact.
3. The battery starts to charge automatically. The amber charge LED on the accessory lights to show the charge status.

The spare battery usually fully charges in less than four hours.

Removing the Main Battery

To remove the main battery:

1. Prior to removing the battery, press the red **Power** button. This sets the mobile computer to suspend mode.
2. For the MC9097, wait 10 seconds before proceeding to the next step. If you do not you may need to perform a warm boot after replacing the battery.
3. Press the primary battery release(s). The battery partially ejects from the mobile computer.
4. Pause 3 to 4 seconds while the mobile computer performs battery removal shutdown.

5. Press the secondary battery release, on top of the battery, and slide the battery out of the mobile computer.

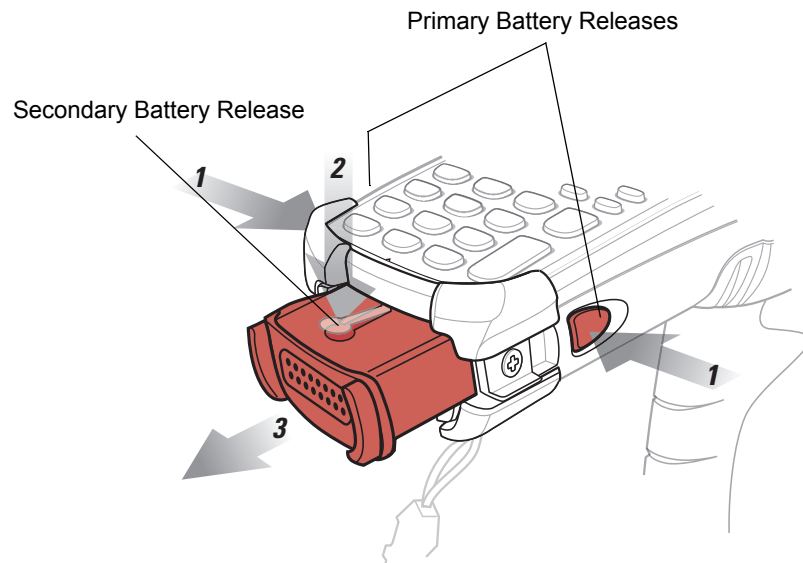

Figure 1-5 Removing the Main Battery - MC909X-G/K

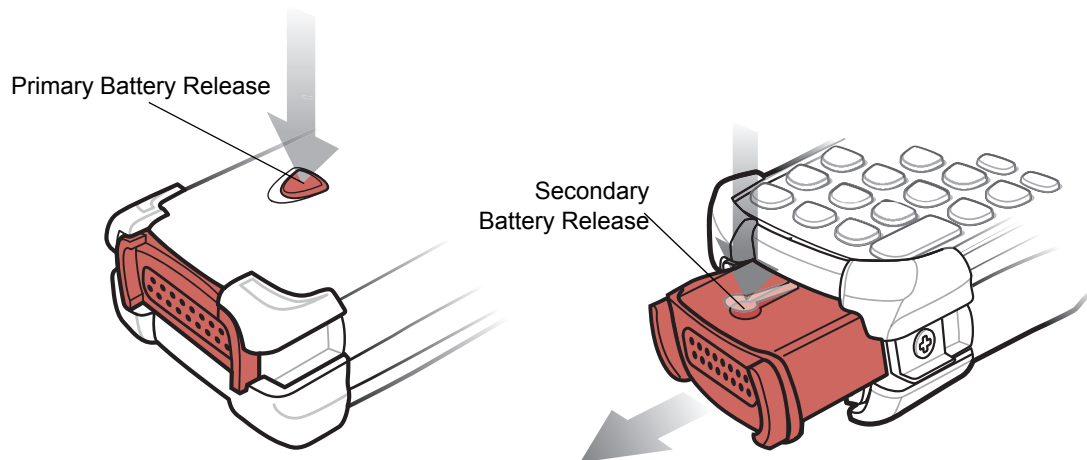

Figure 1-6 Removing the Main Battery - MC909X-S

Starting the Mobile Computer

Press the red **Power** button to turn on the mobile computer. If the mobile computer does not power on, perform a cold boot. See [Resetting the Mobile Computer on page 2-49](#).

- ✓ **NOTE** When a battery is fully inserted in a mobile computer for the first time, upon the mobile computer's first power up, the device boots and powers on automatically.

When the mobile computer is powered on for the first time, it initializes its system. The splash screen ([Figure 1-7](#)) appears for a short period of time.

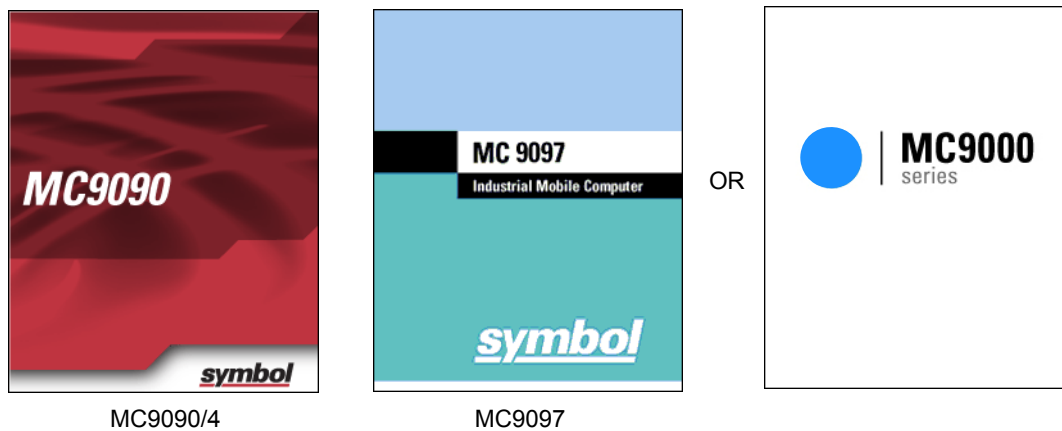

Figure 1-7 Splash Window

Calibrating the Screen

To calibrate the screen so the cursor on the touch screen aligns with the tip of the stylus:

1. Using the stylus carefully press and briefly hold the tip of stylus on the center of each target that appears on the screen.

- ✓ **NOTE** To re-calibrate the screen at anytime, press **FUNC + ESC** on the mobile computer to launch the calibration screen application.

2. Repeat as the target moves around the screen or press **ESC** to cancel.

Checking Battery Status

To check whether the main battery or backup battery in the mobile computer is charged:

- On Windows CE 5.0 devices: tap **Start > Settings > Control Panel > Power** icon to display the **Battery Status** window.
- On Windows Mobile 5.0 devices: tap **Start > Settings > System** tab > **Power** icon to display the **Power** window.

To save battery power, set the mobile computer to turn off after a specified number of minutes.

SIM Card

- ✓ **NOTE** Subscriber Identification Module (SIM) card is only used in the MC9094 and MC9097 configurations.

The SIM card, or smart card, is required for MC9094 (GPRS) phone service and must be obtained from the phone service provider. The MC9097 (iDEN) comes from the factory with an un-activated SIM card installed. You must contact your service provider to activate the SIM card.

- ✓ **NOTE** On the MC9097, it is not recommended that you swap the SIM card with another SIM card.

The card fits into the mobile computer and can contain the following information:

- Mobile phone service provider account details.
- Information regarding service access and preferences.
- Contact information, which can be moved to Contacts on the mobile computer.
- Any additional services to which the user may have subscribed.

- ✓ **NOTE** For more information about SIM cards, refer to the mobile phone service provider's documentation.

To install the SIM card:

1. Place the mobile computer into the suspend mode by pressing the red **Power** button.
2. Remove the SIM housing cover on the back of the mobile computer.

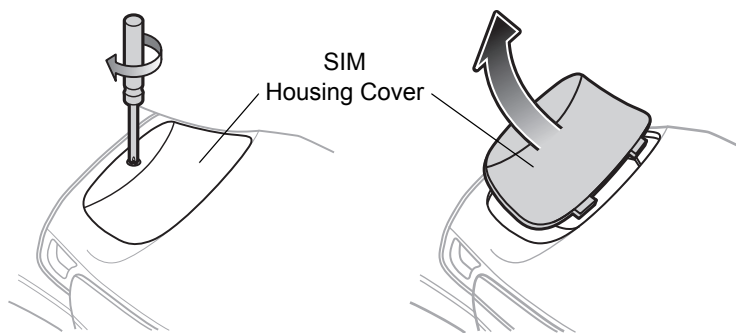

Figure 1-8 Removing SIM Cover

3. Unlock the SIM holder by sliding the metal clip to the open position.
4. Lift the SIM holder.

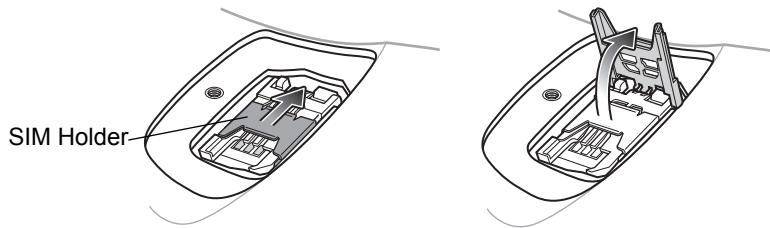

Figure 1-9 *Unlock SIM Case*

5. Insert the SIM card, as shown in [Figure 1-10](#), with the cut edge of the card facing out and the contacts facing down.
6. Lower the SIM holder.

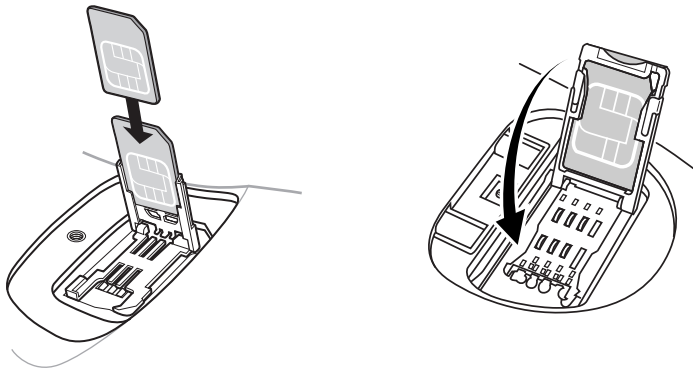

Figure 1-10 *Inserting the SIM Card*

7. Lock the metal clip by sliding it to the closed position.

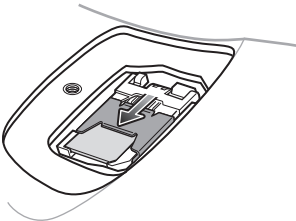

Figure 1-11 *Locking the SIM Card Housing*

8. Replace the SIM housing cover with one screw.

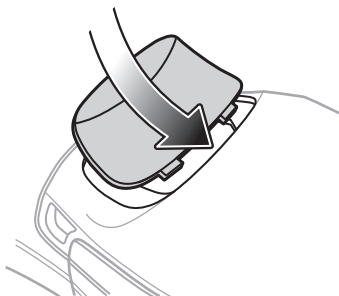

Figure 1-12 *Replacing the SIM Door*

9. Press the red **POWER** button.

✓ **NOTE** On the MC9097, it is not recommended that you swap the SIM card with another SIM card. If you do swap SIM cards, perform step 10.

10. On the MC9097, you must preform a master rest after installing a new SIM Card.

- a. Tap **Start > Phone > Menu > Options > Error Log** tab.
- b. Tap the **Master Reset** button.
- c. Tap **OK**.
- d. Once an “X” appears in the Phone Antenna icon (wait a few seconds), perform a warm boot.
- e. Wait for the mobile computer to reboot and register with the network, then perform a second warm boot.

11. Tap **Start > Phone > Menu > Options > Network** tab and verify that the service provider appears in the **Current network:** field.

12. Make a call to verify connection.

✓ **NOTE** For detailed information about WWAN activation and settings, refer to the *MC909X Integrator Guide*.

On the MC9097, if the SIM door is removed without removing the SIM card, you must warm boot the mobile computer.

Stylus

Use the mobile computer stylus for selecting items and entering information. The stylus functions as a mouse.

- Tap: Touch the screen once with the stylus to press option buttons and open menu items.
- Tap and Hold: Tap and hold the stylus on an item to see a list of actions available for that item. On the pop-up menu that appears, tap the action you want to perform.
- Drag: Hold the stylus on the screen and drag across the screen to select text and images. Drag in a list to select multiple items.

MC9090-G Strap

The strap may be moved to either the left or right side of the mobile computer to suit user preferences.

To reposition the strap:

1. Disconnect the metal clip at the handle.
2. Open strap loop and slide the handstrap through the loop.
3. Slide the loop out of the connector post.
4. Reverse the procedure to re-attach the strap. Two strap connectors are provided on the mobile computer's main body. The handstrap may be attached to either connector.

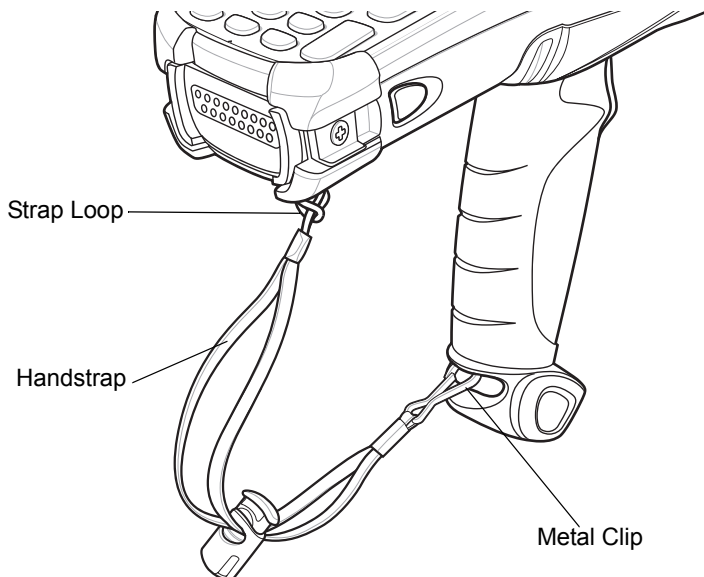

Figure 1-13 *Reposition the Strap*

MC909X-K Strap

The strap may be moved to either the left or right side of the mobile computer to suit user preferences. To reposition the MC909X-K strap:

1. Lift the loop end of the strap over the button.

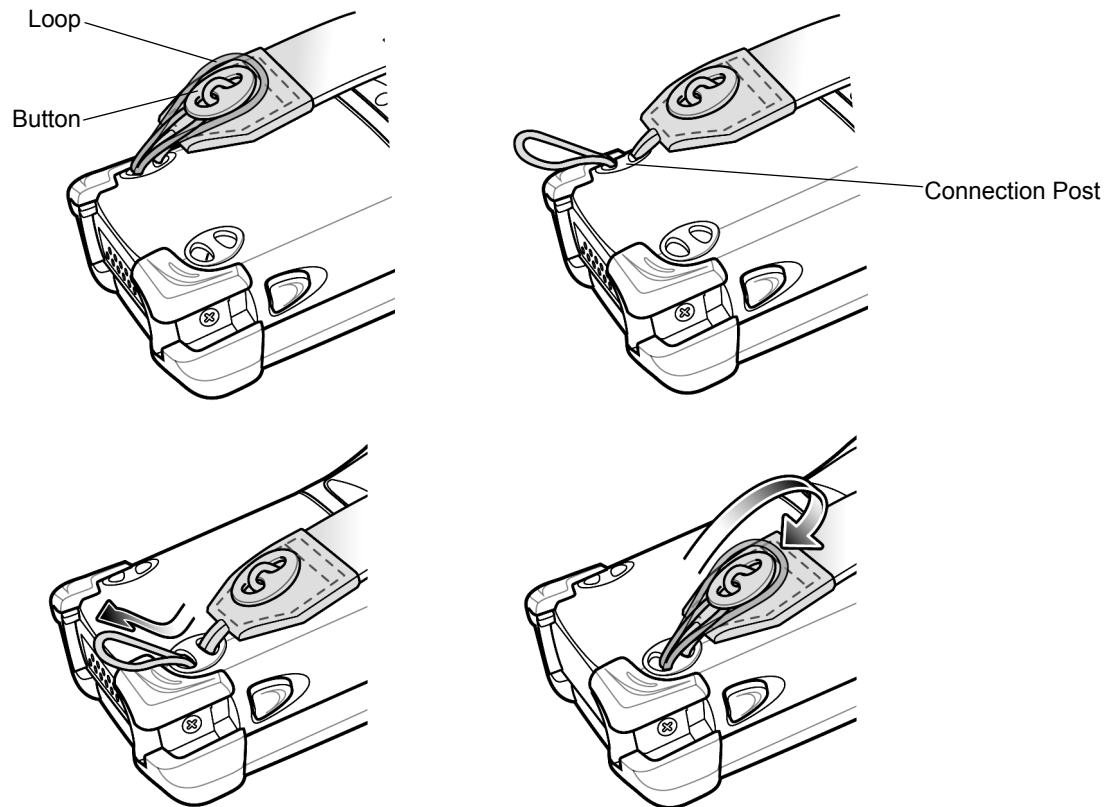

Figure 1-14 *Repositioning the MC909X-K Strap*

2. Pull the loop through the connection post.
3. Remove the battery.
4. Insert the loop into the opposite connection post.
5. Place the loop over the button and pull taught.
6. Replace the battery.

To replace the handstrap:

1. Remove two screws securing the strap bracket to the device.

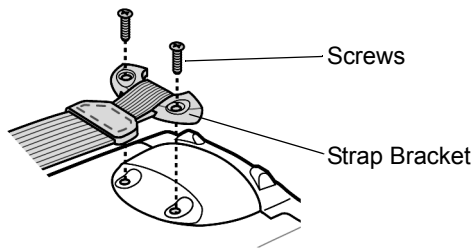

Figure 1-15 Remove Strap Bracket

2. Lift the loop end of the strap over the button.
3. Pull the loop through the connection post.
4. Remove the battery.
5. Reverse the procedure to re-attach the strap.

MC909X-S Strap

The strap may be moved to either the left or right side of the mobile computer to suit user preferences. To reposition the MC909X-S strap, attach the MC909X-S strap to either the left or right side of the mobile computer to suit user preferences. To reposition the strap:

1. Remove the screw securing the bottom of the strap to the device.
2. Position the bottom end of the strap over the opposite screw hole.
3. Secure the strap to the device.

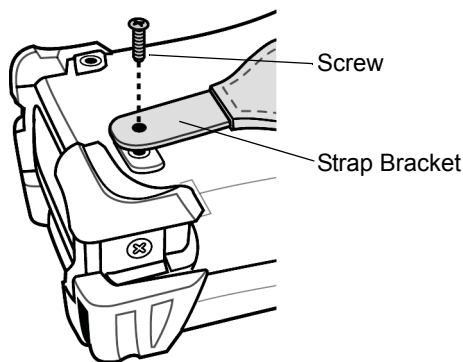

Figure 1-16 Repositioning the MC909X-S Strap

To replace the handstrap:

1. Remove two screws securing the strap bracket to the device.

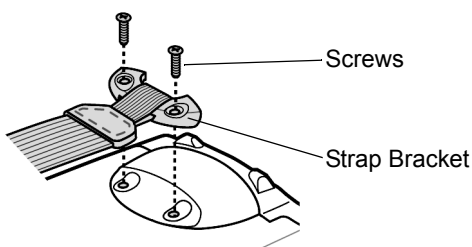

Figure 1-17 Remove Strap Bracket

2. Remove the screw securing the bottom of the strap to the device.
3. Reverse the procedure to re-attach the strap.

Battery Management

Battery Saving Tips

- Leave the mobile computer connected to AC power at all times when not in use.
- Set the mobile computer to turn off after a short period of non-use.
- Set the display and keyboard backlight to turn off after a short period of non-use.
- Turn off all wireless radio activity when not in use.
- Power off the mobile computer when charging to charge at a faster rate.

Changing the Power Settings

To set the mobile computer to turn off after a short period of non-use:

1. On devices with Windows CE 5.0, tap **Start > Settings > Control Panel > Power icon > Power Off** tab.
or
On devices with Windows Mobile 5.0, tap **Start > Settings > System tab > Power icon > Advanced** tab.
2. Select the **On battery power: Turn off device if not used for:** check box and select a value from the drop-down list box.
3. Tap **OK**.

Changing the Display Backlight Settings

To change the display backlight settings in order to conserve more battery power:

1. On devices with Windows CE 5.0, tap **Start > Settings > Control Panel > Backlight icon > Battery Power** tab.
or
On devices with Windows Mobile 5.0, tap **Start > Settings > System tab > Backlight icon > Battery Power** tab.

2. Select the **On battery power: Disable backlight if not used for:** check box and select a value from the drop-down list box.
3. Tap the **Brightness** tab.
4. Tap the **Disable backlight** check box to completely turn off the display backlight.
5. Use the slider to set the brightness of the backlight. Set it to a low value to save battery power.
6. Tap **OK**.

Changing the Keypad Backlight Settings

To change the keypad backlight settings in order to conserve more battery power:

1. On devices with Windows CE 5.0, tap **Start > Settings > Control Panel > Keylight icon > Battery Power** tab.
or
On devices with Windows Mobile 5.0, tap **Start > Settings > System tab > Keylight icon > Battery Power** tab.
2. Select the **On battery power: Disable keylight if not used for:** check box and select a value from the drop-down list box.
3. Tap the **Advanced** tab.
4. Tap the **Disable keylight** check box to completely turn off the display backlight.
5. Tap **OK**.

Turning Off the Radios

On Devices with Mobile 5.0 AKU 1.0

✓ **NOTE** To determine the operating system AKU version, see [Configurations on page vi](#).

Turning Off the WLAN Radio

To turn off the WLAN radio tap the **Wireless Connection Status** icon at the bottom of the Today screen and select **Disable Radio**. A red X appears across the icon indicating that the radio is disabled (off).

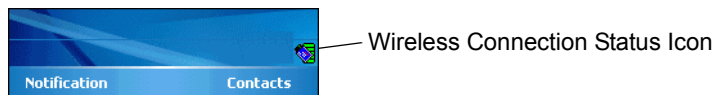



Figure 1-18 *Wireless Connection Status Icon*



To turn the radio back on, tap the **Wireless Connection Status** icon at the bottom of the Today screen and select **Enable Radio**. The red X disappears from the icon indicating that the radio is enabled (on).

Bluetooth and WWAN Radios

- ✓ **NOTE** The Flight Mode feature only turns off the WWAN and Bluetooth radios. The WLAN radio must be turned off separately.

To turn off the Bluetooth and WWAN radios, tap the **Connectivity** icon  (on non-WWAN devices) or the **Antenna/Signal** icon  (on WWAN devices) and select **Turn On Flight Mode**.

- ✓ **NOTE** On the MC9097, it takes two to five seconds for the radio to shut down.

To turn on the Bluetooth and WWAN radios, tap the **Connectivity** icon  (on non-WWAN devices) or the **Antenna/Signal** icon  (on WWAN devices) and select **Turn Off Flight Mode**.

- ✓ **NOTE** On the MC9097, wait 20 to 40 seconds for the radio to power on. During this time do not suspend the mobile computer or remove the battery. If the mobile computer is suspended or the battery is removed, warm boot the mobile computer.

On Devices with Mobile 5.0 AKU 2.2 and higher

- ✓ **NOTE** To determine the operating system AKU version, see [Configurations on page vi](#).

Windows Mobile 5.0 devices with AKU 2.2 and higher include **Wireless Manager**, which provides a simple method of enabling, disabling, and configuring all the device's wireless capabilities in one place.

To open **Wireless Manager**, tap the **Connectivity** icon.



Figure 1-19 Opening Wireless Manager

Select **Wireless Manager**.

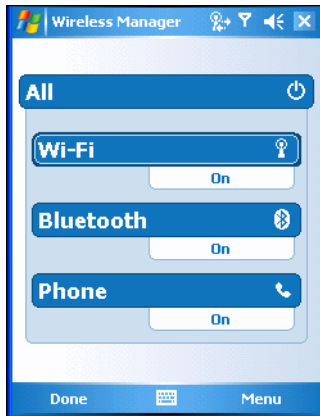

Figure 1-20 *Wireless Manager Window*

To enable or disable a wireless connection, tap its blue bar.

To enable or disable all wireless connections, tap and hold the **All** bar.

To configure settings for a connection, tap **Menu**.



Figure 1-21 *Wireless Manager Menu*

On Device with CE 5.0 (OEM Version 01.15 and lower)

✓ **NOTE** To determine the operating system OEM version, see [Configurations on page vi](#).

WLAN Radio

To turn off the WLAN radio:

1. Tap **Start** > **Settings** > **Control Panel** > **Power icon** > **PwrDevices** tab.
2. In the text box, scroll down until **WLP1:** displays.
3. Select **WLP1:**. **WLP1:** displays in the text box at the top of the window.
4. In the drop-down list box, select **D4**.
5. Tap **Set**.

To turn on the radio:

1. Tap **Start > Settings > Control Panel > Power icon > PwrDevices** tab.
2. In the text box, scroll down until **WLP1:** displays.
3. Select **WLP1:**. **WLP1:** displays in the text box at the top of the window.
4. In the drop-down list box, select **D0**.
5. Tap **Set**.

Bluetooth Radio

To turn off the Bluetooth radio, tap **Bluetooth** icon in the task tray and select **Disable Bluetooth**.



Figure 1-22 *Bluetooth Icon*

To turn on the Bluetooth radio, tap **Bluetooth** icon in the task tray and select **Enable Bluetooth**.

On Device with CE 5.0 (OEM Version 01.16 and higher)

✓ **NOTE** To determine the operating system OEM version, see [Configurations on page vi](#).

WLAN Radio

To turn off the WLAN radio tap the **Wireless Connection Status** icon on the task tray and select **Disable Radio**. A red X appears across the icon indicating that the radio is disabled (off).

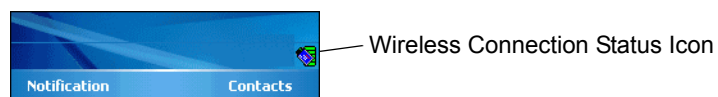

Figure 1-23 *Wireless Connection Status Icon*

To turn the radio back on, tap the **Wireless Connection Status** icon on the task tray and select **Enable Radio**. The red X disappears from the icon indicating that the radio is enabled (on).

Bluetooth Radio

To turn off the Bluetooth radio, tap **Bluetooth** icon in the task tray and select **Disable Bluetooth**.



Figure 1-24 *Bluetooth Icon*

To turn on the Bluetooth radio, tap **Bluetooth** icon in the task tray and select **Enable Bluetooth**.

Chapter 2 Operating the MC909X

Introduction

This chapter explains the physical buttons, status icons and controls on the mobile computer, how to use the mobile computer, including instructions for powering on and resetting the mobile computer, using the stylus and a headset, entering information and scanning.

Status Icons (Windows CE 5.0)

The **Taskbar** at the bottom of the window displays the active programs, current time, battery status and communication status.

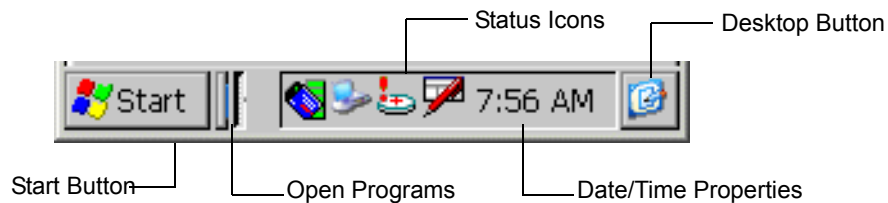



















Figure 2-1 *Taskbar*

Status icons are shown in the taskbar to indicate present status of the mobile computer. Double tapping each status icon displays the corresponding setup window and enables you to change or adjust its settings from the window.

Table 2-1 Status Icons

Status Icon	Description
	Indicates the current time.
	This icon indicates that the keyboard input panel is selected.
	This icon indicates that the keyboard input panel is hidden.
	This icon indicates that the main battery is charging or that the terminal is operating on AC power. Double tapping on this icon opens the Power Properties window.
	Indicates that the battery is fully charged and the mobile computer is running on external power.
	This icon is displayed when the memory backup battery level is low. Charge the battery.
	This icon indicates that the battery is fully charged (100% charged). The battery status icons provide the battery status in 10% increments from 10% to 100%.
	It is displayed when the terminal is connected to a host computer with a serial cable.
	Wireless connection status icon. Indicates WLAN signal strength.
	The Bluetooth Enabled icon appears in the task tray and indicates that the Bluetooth radio is on.
	The Bluetooth Disabled icon appears in the task tray and indicates that the Bluetooth radio is off.
	The Bluetooth Communication icon appears in the task tray and indicates that the mobile computer is communicating with another Bluetooth device.
	Indicates that the SHIFT button function is selected.
	Indicates that the FUNC button function is selected.
	Indicates that the CTRL button function is selected.
	Indicates that the ALT character selection is selected.
	Indicates that the mobile computer is in ALPHA button mode is selected.

Status Icons (Windows Mobile 5.0)

Status Bar

The **Status Bar** at the top of the window displays the current time, battery status and communication status.

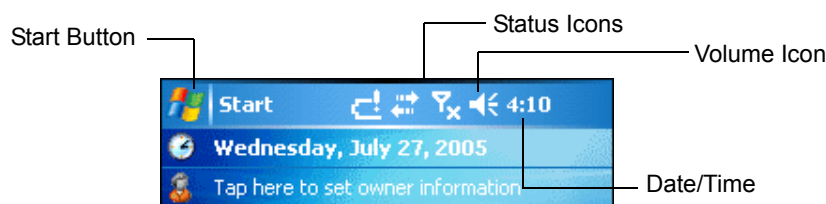

Figure 2-2 Status Bar



















Status icons are shown in the **Status Bar** to indicate present status of the mobile computer. Tapping each status icon displays the corresponding dialog box and enables you to change or adjust its settings. You may see the status icons listed in [Table 2-2](#) on the **Status Bar** located at the top of the screen.

Table 2-2 Status Icons

Icon	Function	Description
	Audio	Speaker is on.
		Speaker is off.
	Battery	Backup battery is very low.
		Main battery is charging.*
		Main battery is low. (AKU 2.2.1 and lower)
		Main battery is very low. (AKU 2.2.1 and lower)
		Main battery is full.* (AKU 2.2.1 and lower)
		Main battery level.* (AKU 3.2 and higher)
		Main battery is very low.*
		Connectivity
	ActiveSync error	
	GPRS available.	
	GPRS in use.	
	EGPRS available.	
	EGPRS in use.	
	Synchronization is occurring.	
	Synchronization is occurring.	

* Only appears in the *Time and Next Appointment* dialog box.

Table 2-2 Status Icons (Continued)

Icon	Function	Description
	WWAN	Call missed.
		Voice call.
		Voice call in progress.
		Data call in progress.
		Calls are forwarded.
		Call on hold.
		Antenna/signal icon: wireless on/good signal.
		Antenna/signal icon: wireless off.
		Antenna/signal icon: no service or searching.
		Antenna/signal icon: lost signal.
		Antenna/signal icon: no signal.
		Roaming icon. Outside of your home area.
		Missing SIM Card icon: SIM Card not installed or installed improperly.
	Instant Message	Notification that one or more instant messages were received.
	E-Mail	Notification that one or more e-mail messages were received.
	Voice Mail	Notification that one or more voice messages were received.
	Time and Next Appointment	Displays current time in analog or digital format.
	Multiple Notifications	There are more notification icons than can be displayed. Tap to display remaining icons.

* Only appears in the *Time and Next Appointment* dialog box.

Command Bar

You may see the icons listed in [Table 2-3](#) on the Command Bar located at the bottom of the screen.

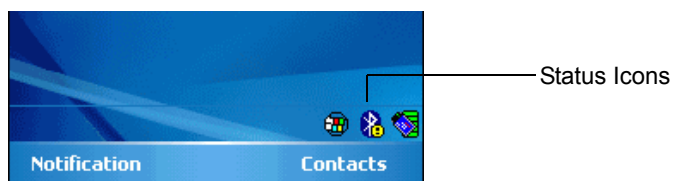







Figure 2-3 Command Bar

Table 2-3 Command Bar Icons

Icon	Description
	Wireless connection status icon. Indicates WLAN signal strength and opens the Wireless Applications menu.
	The Bluetooth Enabled icon appears in the task tray and indicates that the Bluetooth radio is on.
	The Bluetooth Disabled icon appears in the task tray and indicates that the Bluetooth radio is off.
	The Bluetooth Communication icon appears in the task tray and indicates that the mobile computer is communicating with another Bluetooth device.
	The ActiveSync icon appears in the task tray and indicates an active serial connection between the mobile computer and the development computer.

Speaker Icon

You can adjust the system volume and the phone volume (on MC9094 and MC9097 devices) using the **Speaker** icon in the Status bar.

1. Tap the **Speaker** icon. The **Volume** dialog box appears.

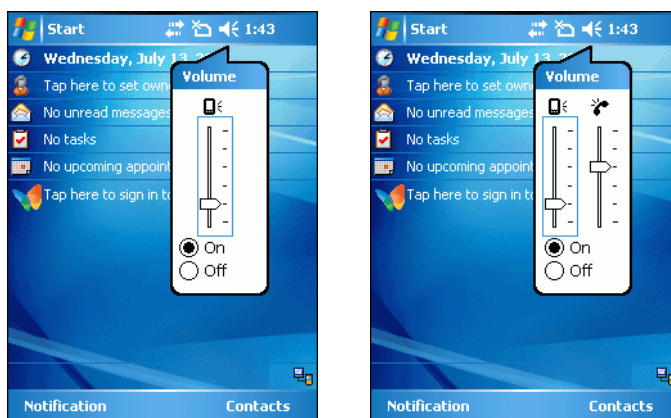

Figure 2-4 Volume Dialog Box

✓ **NOTE** When not in a call, the phone volume slider adjusts the volume of the ringer. When in a call, adjusts the volume of the call audio.

2. Tap and move the slide bar to adjust the volume.
3. Select the **On** or **Off** radio button to turn the volume on or off.



NOTE Use can also adjust the system volume using the **Sounds & Notifications** window or by pressing the Blue key and 6 or the Blue key and 7.

Battery Icon

In AKU 2.2.1 and lower, the **Battery** icons display on the **Title Bar** when the main battery or backup battery power falls below a predetermined level. A **Battery** dialog box also appears indicating the status of the main or backup battery.

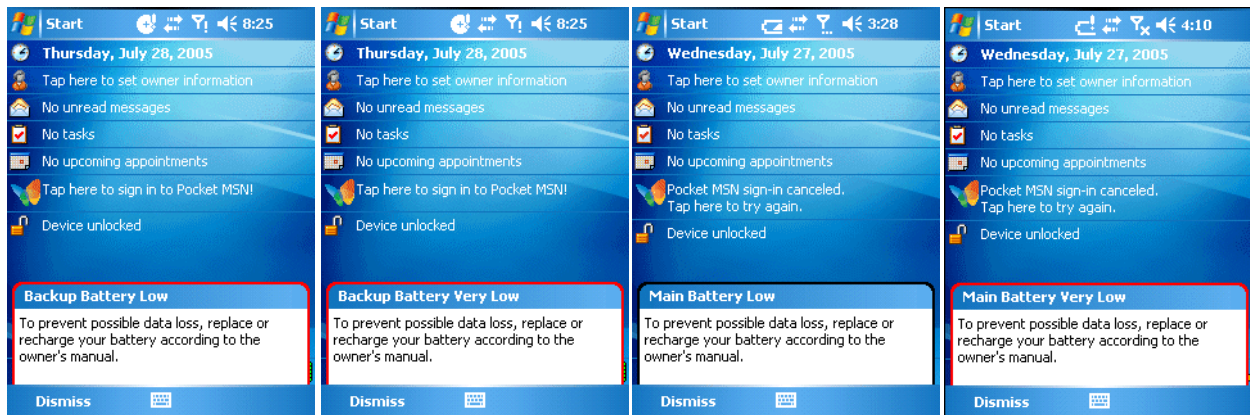

Figure 2-5 Battery Status Dialog Box

AKU 3.2 and higher, the **Battery** icon always appears in the **Title Bar** when the Today screen is visible. The icon indicates the battery power level.



Figure 2-6 Battery Icon on the Title Bar

You can also view the battery status using the **Power** window.

Connectivity Icon

The **Connectivity** icon indicates the communication status of the terminal when it's connecting to the internet or host computer.

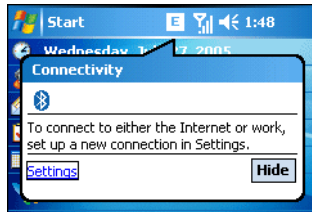

Figure 2-7 Connectivity Dialog Box

Time Icon

- ✓ **NOTE** In AKU 2.2 and higher, the **Time** icon only appears in the **Title Bar** when an application displays. It does not appear in the **Title Bar** when the **Today** screen displays.

The **Time** icon displays the current time in a digital or analog format. To change the time format, tap and hold the **Time** icon until a menu appears. Select the format you want.

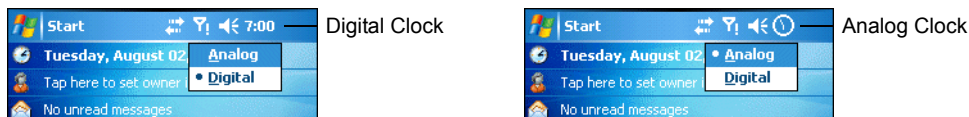

Figure 2-8 Time Icon Format Menu

To display current date, time and appointments:

1. Tap the **Time** icon to display the **Time and Next Appointment** dialog box.

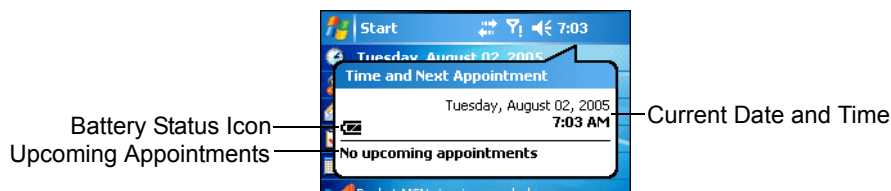

Figure 2-9 Time and Next Appointment Dialog Box

2. The dialog box displays the current date and time, the battery status and any upcoming appointments in the **Calendar**.

Instant Message Icon

The **Instant Message** icon notifies you when **MSN Messenger** has received a new incoming message.

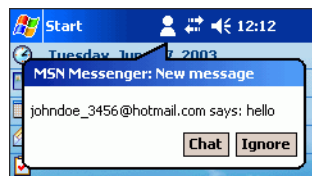

Figure 2-10 MSN Messenger Dialog Box

E-Mail Icon

The **E-Mail** icon notifies you when you have received incoming e-mails.

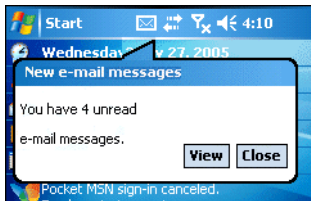

Figure 2-11 *New E-mail Messages Dialog Box*

Multiple Notification Icon

The **Multiple Notification** icon appears when two or more message notifications occur. Tap the icon to display the multiple notification icons.

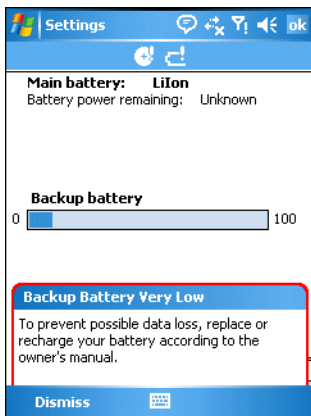

Figure 2-12 *Multiple Notifications Icon*

Locking the Mobile Computer (Windows Mobile 5.0 Only)

Use the Device Lock feature to prevent use of the device. Note that when locked, the mobile computer does not respond to screen or keypad input.

To lock the device, tap the **Device unlocked** icon. The icon changes to locked.

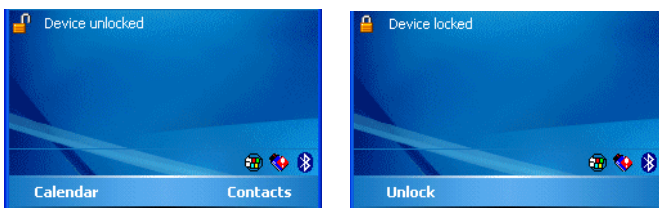

Figure 2-13 *Device Locked/Unlocked Icons*

To unlock the device and free it for use, tap **Unlock**.

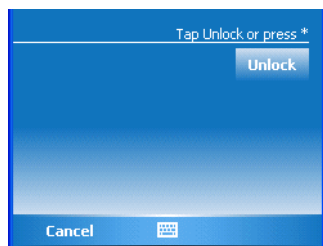

Figure 2-14 *Unlock Device Window*

Tap **Unlock** on the **Unlock Device** window.

LED Indicators

The MC909X has an LED Indicator Bar that contains LEDs that indicate scanning and charging status. [Table 2-4](#) describes the LED indications.

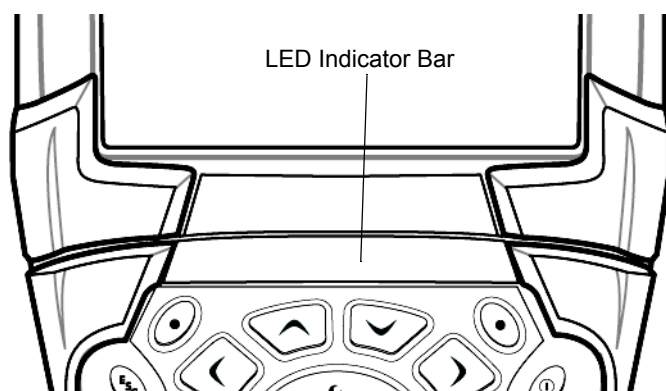

Figure 2-15 *MC909X LEDs Indicator Bar*

Table 2-4 *Mobile Computer LED Indications*

LED State	Indication
Solid Red	Laser enabled, scanning/imaging in process.
Solid Green	Successful decode/capture.
Slow Blinking Amber	Main battery in mobile computer is charging.
Fast Blinking Amber	Error in charging; check placement of the mobile computer.
Solid Amber	Main battery in mobile computer is fully charged.

Keypads

The mobile computer has the following interchangeable modular keypads:

- 28-key keypad (MC909X-K and MC9090-G only)
- 28-key keypad (MC909X-S only)
- 33-key keypad (MC909X-K only)
- 38-key numeric/function keypad (MC909X-S only)
- 38-key alpha/shifted numeric keypad (MC909X-S only).
- 43-key keypad (MC909X-K and MC9090-G only)
- 53-key keypad (MC909X-K and MC9090-G only)
- 3270 Emulator (MC9090-G only)
- 5250 Emulator (MC9090-G only)
- VT Emulator. (MC9090-G only).

The modular keypads can be changed in the field, as necessary, to support specialized applications. Refer to the *MC909X Integrator Guide* for installation and removal procedures.

✓ **NOTE** For information about using the soft keyboard input panel, refer to the *Microsoft Application Guide for Zebra Devices*.

28-Key Keypad for MC909X-G/K

The 28-key keypad contains a **Power** button, application keys, scroll keys and function keys. The keypad is color-coded to indicate the alternate function key (blue) values. Note that keypad functions can be changed by an application so the mobile computer's keypad may not function exactly as described. See [Table 2-5 on page 2-13](#) for key and button descriptions and [Table 2-14 on page 2-43](#) for the keypad's special functions.

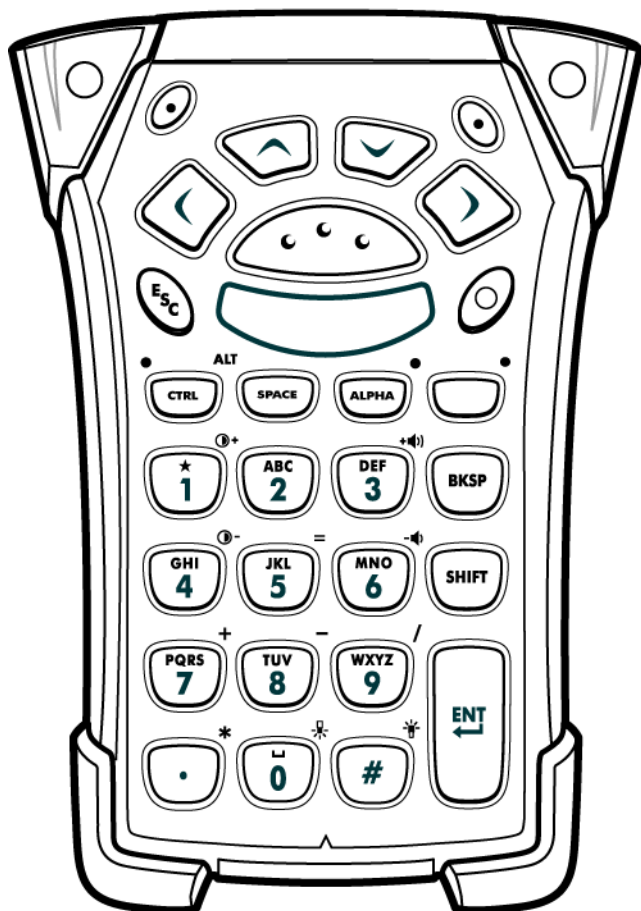

Figure 2-16 28-Key Keypad for MC909X-G/K

28-Key Keypad for MC909X-S

The 28-key keypad contains a **Power** button, application keys, scroll keys and function keys. The keypad is color-coded to indicate the alternate function key (blue) values. Note that keypad functions can be changed by an application so the mobile computer's keypad may not function exactly as described. See [Table 2-5 on page 2-13](#) for key and button descriptions and [Table 2-14 on page 2-43](#) for the keypad's special functions.

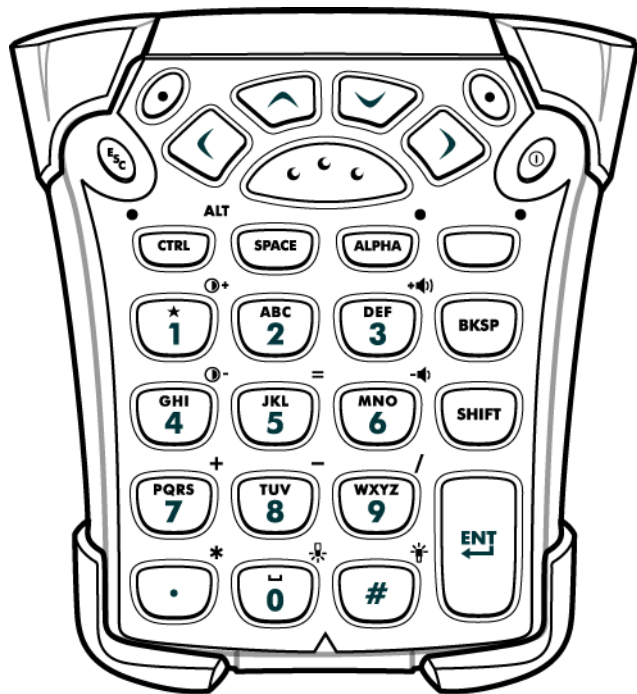

Figure 2-17 28-Key Keypad for MC909X-S

Table 2-5 28-Key Descriptions







Key	Description
Power (red) 	Turns the mobile computer on and off. Performs a warm boot when held down for five seconds. See Windows Mobile 5.0 Devices on page 2-50 for information about performing a warm boot.
Green/Red Dot 	MC9094 and MC9097: Green dot: press to display the phone keypad window or to dial a phone number (from the phone keypad window). Red dot: press on phone keypad window to stop dialing or end a call. MC9090: To use a key as an application key (APP key) on the keyboard, a new keyboard remap table must be created and installed. However, the Green/Red dot keys can be remapped as APP keys through the registry. Create an XML Provisioning file with the following entries: Characteristic type = "HKEY_LOCAL_MACHINE\HARDWARE\DEVICEMAP\KEYBD" Parm name = "GreenKeyOverride" value = "xx", where xx is the new APP key code. Parm name = "RedKeyOverride" value = "xx", where xx is the new APP key code. Refer to the <i>MC909X Integrator Guide</i> for instruction on updating the registry using XML Provisioning. This sends an APP key code, instead of their original key codes, when the green or red dot key is pressed.
Scan (yellow) 	Activates the scanner/imager in a scan enabled application.
Scroll Up and Down 	Moves up and down from one item to another. Increases/decreases specified values.
Scroll Left and Right 	Moves left and right from one item to another. Increases/decreases specified values.
ESC 	Exits the current operation.
One/Star 	Produces the number one in default state. Produces an asterisk in Alpha state.

Table 2-5 28-Key Descriptions (Continued)





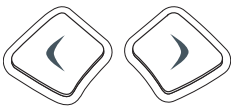













Key	Description
Alphanumeric 	<p>In default state, produces the numeric value on the key.</p> <p>In Alpha state, produces the lower case alphabetic characters on the key. Each key press produces the next alphabetic character in sequence. For example, press and release the ALPHA key and then press the '4' key once to produce the letter 'g'; press and release the ALPHA key and then press the '4' key three times to produce the letter 'i'.</p> <p>When the SHIFT key is pressed in Alpha state, the upper case alphabetic characters on the key are produced. For example, press and release the ALPHA key, press and release the SHIFT key and then press the '4' key once to produce the letter 'G'; press and release the ALPHA key, press and release the SHIFT key and then press the '4' key three times to produce the letter 'I'.</p>
SPACE/BKSP 	Space and backspace functions.
CTRL (Control) 	<p>Press and release the CTRL key to activate the keypad alternate CTRL functions. The LED above the key lights and the  icon appears on the taskbar on WinCE devices or the  icon appears at the bottom of the screen on Windows Mobile 5.0 devices.</p> <p>Press the Blue key followed by the CTRL key to activate the keypad alternate ALT functions. The ALT icon appears on the taskbar on WinCE devices or the  icon appears at the bottom of the screen on Windows Mobile 5.0 devices.</p>
ALPHA 	<p>Press and release the ALPHA key to activate the keypad alternate functions (shown on the keypad in orange). The LED above the key lights when the key is depressed. The  icon appears on the taskbar on WinCE devices and the  icon appears at the bottom of the screen on Windows Mobile 5.0 devices. Press and release the ALPHA key again to return to the normal keypad functions.</p>
Function (blue) 	<p>Press and release the blue function key to activate the keypad alternate functions (shown on the keypad in blue). The LED above the key lights and the  icon appears on the taskbar on WinCE devices or the  icon appears at the bottom of the screen on Windows Mobile 5.0 devices. Press and release the blue function key again to return to the normal keypad functions.</p>
SHIFT 	<p>Press and release the SHIFT key to activate the keypad alternate SHIFT functions. The  icon appears on the taskbar on WinCE devices and the  icon appears at the bottom of the screen on Windows Mobile 5.0 devices. Press and release the SHIFT key again to return to the normal keypad functions.</p>

Table 2-5 28-Key Descriptions (Continued)

Key	Description
ENT (Enter) 	Executes a selected item or function. For Windows Mobile 5.0: The default behavior of the ENT (Enter) key sends an extra character, which causes a Microsoft Word or Notes application to exit. To make the applications work properly, create an XML Provisioning file with the following entries: Characteristic type = "HKEY_LOCAL_MACHINE\HARDWARE\DEVICEMAP\KEYBD" Para name = "SpecialEnterTabKey" value = 0 Refer to the <i>MC909X Integrator Guide</i> for instruction on updating the registry using XML Provisioning.
Period/Decimal Point 	In default state, produces a period for alpha entries and a decimal point for numeric entries. In function key state, produces an asterisk. When the SHIFT key is pressed in function key state, produces an asterisk.
Zero 	In default state, produces a zero. In Alpha state, produces a space.
Pound 	Produces a pound/number sign.

33-Key Numeric/Function Keypad for MC909X-K

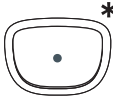
The 33-key numeric/function keypad contains a **Power** button, application keys, scroll keys and a function key. The keypad is color-coded to indicate the alternate function key (blue) values and the alternate alpha key (orange) values. Note that keypad functions can be changed by an application so the mobile computer's keypad may not function exactly as described. See [Table 2-5 on page 2-13](#) for key and button descriptions and [Table 2-14 on page 2-43](#) for the keypad's special functions.

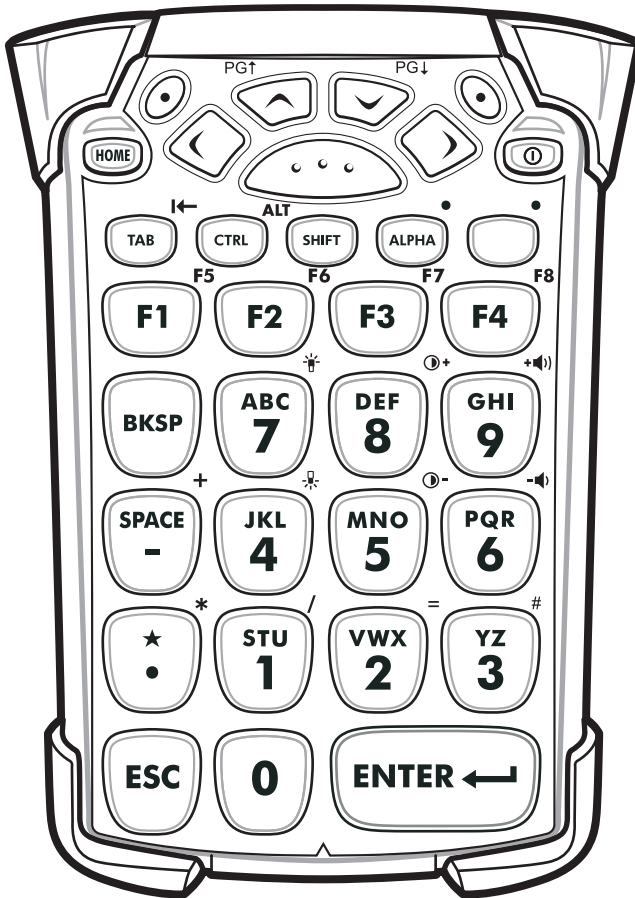

Figure 2-18 33-Key Numeric/Function Keypad for MC909X-K

Table 2-6 33-Key Keypad Descriptions







Key	Description
Power (red) 	Turns the mobile computer on and off. Performs a warm boot and a cold boot. See Windows Mobile 5.0 Devices on page 2-50 for information about performing a warm and cold boot.
Green/Red Dot 	MC9094 and MC9097: Green dot: press to display the phone keypad window or to dial a phone number (from the phone keypad window). Red dot: press on phone keypad window to stop dialing or end a call. MC9090: To use a key as an application key (APP key) on the keyboard, a new keyboard remap table must be created and installed. However, the Green/Red dot keys can be remapped as APP keys through the registry. Create an XML Provisioning file with the following entries: Characteristic type = "HKEY_LOCAL_MACHINE\HARDWARE\DEVICEMAP\KEYBD" Parm name = "GreenKeyOverride" value = "xx", where xx is the new APP key code. Parm name = "RedKeyOverride" value = "xx", where xx is the new APP key code. Refer to the <i>MC909X Integrator Guide</i> for instruction on updating the registry using XML Provisioning. This sends an APP key code, instead of their original key codes, when the green or red dot key is pressed.
Scan (yellow) 	Activates the scanner/imager in a scan enabled application.
Scroll Up and Down 	Moves up and down from one item to another. Increases/decreases specified values.
Scroll Left and Right 	Moves left and right from one item to another. Increases/decreases specified values.
ESC 	Exits the current operation.
Dash/SPACE 	Produces a dash in the default state or a space in the Alpha state.

Table 2-6 33-Key Keypad Descriptions (Continued)

















Key	Description
Alphanumeric 	<p>In default state, produces the numeric value on the key.</p> <p>In Alpha state, produces the lower case alphabetic characters on the key. Each key press produces the next alphabetic character in sequence. For example, press and release the ALPHA key and then press the '4' key once to produce the letter 'r'; press and release the ALPHA key and then press the '6' key three times to produce the letter 'r'.</p> <p>When the SHIFT key is pressed in Alpha state, the upper case alphabetic characters on the key are produced. For example, press and release the ALPHA key, press and release the SHIFT key and then press the '4' key once to produce the letter 'J'; press and release the ALPHA key, press and release the SHIFT key and then press the '4' key three times to produce the letter 'I'.</p>
Application 	<p>These keys can have an application assigned to the function value.</p> <p>On Windows Mobile 5.0 devices: F6 and F7 keys cannot be remapped and are dedicated by the Operating System to control volume level. When these keys are pressed, Shell.exe traps them and displays the volume adjustment window. To get these keys to an application, call GXOpenInput() at the beginning of the application and call GXCLOSEInput() at the end of the application. This redirects all of the key events to an application, including the F6 and F7 keys.</p> <p>Note: Other applications cannot receive any key event until GXCLOSEInput() is called. For example, if the customer is using the APP1 key to run Calc.exe, this is disabled during this period.</p>
Function (blue) 	<p>Press and release the blue function key to activate the keypad alternate functions (shown on the keypad in blue). The LED above the key lights and the  icon appears at the bottom of the screen. Press and release the blue function key again to return to the normal keypad functions.</p>
Control 	<p>Press and release the CTRL key to activate the keypad alternate CTRL functions. The LED above the key lights and the  icon appears on the taskbar on WinCE devices or the  icon appears at the bottom of the screen on Windows Mobile 5.0 devices.</p> <p>Press the Blue key followed by the CTRL key to activate the keypad alternate ALT functions. The ALT icon appears on the taskbar on WinCE devices or the  icon appears at the bottom of the screen on Windows Mobile 5.0 devices.</p>
ALPHA 	<p>The default keypad mode is the num-lock (number lock) mode. Press the orange ALPHA key to de-activate the num-lock mode and to access the alternate ALPHA characters (shown on the keypad in orange). The LED above the key lights and the  icon appears on the taskbar on WinCE devices or the  icon appears at the bottom of the screen on Windows Mobile 5.0 devices. Press and release the ALPHA key again to return to the normal keypad functions.</p>
Shift 	<p>Press and release the SHIFT key to activate the keypad alternate SHIFT functions. The  icon appears on the taskbar on WinCE devices or the  icon appears at the bottom of the screen on Windows Mobile 5.0 devices. Press and release the SHIFT key again to return to the normal keypad functions.</p> <p>Use with the orange alpha-lock key for alpha character value.</p>

Table 2-6 33-Key Keypad Descriptions (Continued)

Key	Description
Period/Decimal Point 	Produces a decimal point for numeric entries. Produces a period for alpha entries when the ALPHA function key is activated.
HOME 	Moves the cursor to the beginning of a line.
ENTER 	Executes a selected item or function. For Windows Mobile 5.0: The default behavior of the ENTER key sends an extra character, which causes a Microsoft Word or Notes application to exit. To make the applications work properly, create an XML Provisioning file with the following entries: Characteristic type = "HKEY_LOCAL_MACHINE\HARDWARE\DEVICEMAP\KEYBD" Para name = "SpecialEnterTabKey" value = 0 Refer to the <i>MC909X Integrator Guide</i> for instruction on updating the registry using XML Provisioning.

38-Key Numeric/Function Keypad for MC909X-S

The 38-key numeric/function keypad contains a **Power** button, application keys, scroll keys and a function key. The keypad is color-coded to indicate the alternate function key (blue) values and the alternate alpha key (orange) values. Note that keypad functions can be changed by an application so the mobile computer's keypad may not function exactly as described. See [Table 2-5 on page 2-13](#) for key and button descriptions and [Table 2-14 on page 2-43](#) for the keypad's special functions.

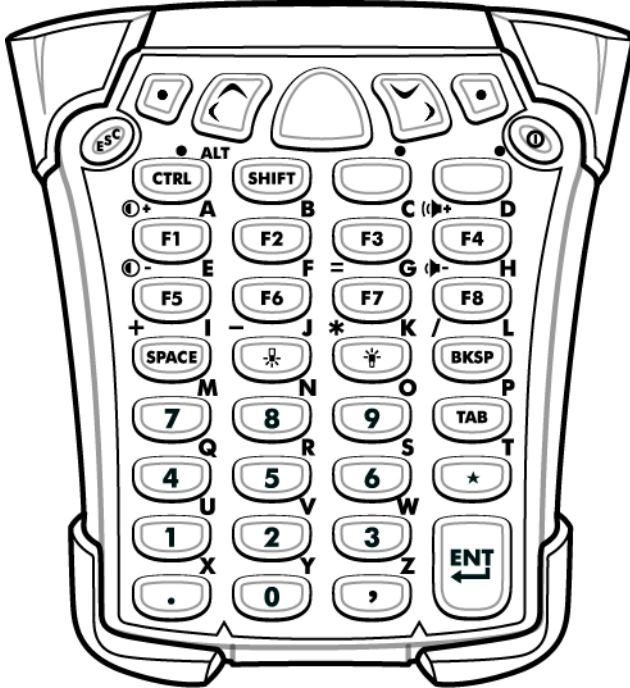

Figure 2-19 38-Key Numeric/Function Keypad for MC909X-S

Table 2-7 38-Key Numeric/Function for MC909X-S Keypad Descriptions









Key	Description
Power (red) 	Turns the mobile computer on and off. Performs a warm boot when held down for 5 seconds. See Windows Mobile 5.0 Devices on page 2-50 for information about performing a warm boot.
Green/Red Dot 	MC9094 and MC9097: Green dot: press to display the phone keypad window or to dial a phone number (from the phone keypad window). Red dot: press on phone keypad window to stop dialing or end a call. MC9090: To use a key as an application key (APP key) on the keyboard, a new keyboard remap table must be created and installed. However, the Green/Red dot keys can be remapped as APP keys through the registry. Create an XML Provisioning file with the following entries: Characteristic type = "HKEY_LOCAL_MACHINE\HARDWARE\DEVICEMAP\KEYBD" Parm name = "GreenKeyOverride" value = "xx", where xx is the new APP key code. Parm name = "RedKeyOverride" value = "xx", where xx is the new APP key code. Refer to the <i>MC909X Integrator Guide</i> for instruction on updating the registry using XML Provisioning. This sends an APP key code, instead of their original key codes, when the green or red dot key is pressed.
Scan (yellow) 	Activates the scanner/imager in a scan enabled application.
Scroll Up and Left 	Moves up by default. Use with the orange alpha-lock key to move left.
Scroll Down and Right 	Moves down by default. Use with the orange alpha-lock key to move right.
ESC 	Exits the current operation.
CTRL (Control) LED  AL	Press and release the CTRL key to activate the keypad alternate CTRL functions. The  icon appears at the bottom of the screen. The LED above the key lights when the key is depressed. Press the Blue key followed by the CTRL key to activate the keypad alternate ALT functions. The  icon appears at the bottom of the screen.

Table 2-7 38-Key Numeric/Function for MC909X-S Keypad Descriptions (Continued)















Key	Description
Alpha-lock (orange) 	Press and release the orange alpha-lock key to activate the keypad alternate alpha-lock functions (shown on the keypad in orange). The LED above the key lights and the  icon appears at the bottom of the screen. Press and release the orange alpha-lock key again to return to the default keypad functions.
Function (blue) 	Press and release the blue function key to activate the keypad alternate functions (shown on the keypad in blue). The LED above the key lights and the  icon appears at the bottom of the screen. Press and release the blue function key again to return to the normal keypad functions.
Special Function/Alpha 	Programmable function (F1, F2, F3) by default. Use with the orange key for alpha character value. Use the blue key for function value.
SPACE 	SPACE function by default. Use with the orange key for alpha character value. Use the blue key for function value.
BKSP 	Backspace function by default. Use with the orange alpha-lock key for alpha character value. Use the blue function key for function value.
Numeric 	Use for numeric characters by default. Use with the orange alpha-lock key for alpha character value. Use the blue function key for function value.
TAB 	Use for tab functions by default. Use with the orange alpha-lock key for alpha character value. Use the blue function key for function value.
SHIFT 	Press and release the SHIFT key to activate the keypad alternate SHIFT functions. The  icon appears at the bottom of the screen. Press and release the SHIFT key again to return to the normal keypad functions. Use with the orange alpha-lock key for alpha character value.

Table 2-7 38-Key Numeric/Function for MC909X-S Keypad Descriptions (Continued)

Key	Description
Period/Decimal Point 	In default state, produces a period for alpha entries and a decimal point for numeric entries. Use with the orange alpha-lock key for alpha character value.
Star 	In default state, produces an asterisk. Use with the orange alpha-lock key for alpha character value.
ENT (Enter) 	Executes a selected item or function. The default behavior of the ENT (Enter) key sends an extra character, which causes a Microsoft Word or Notes application to exit. To make the applications work properly, create an XML Provisioning file with the following entries: Characteristic type = "HKEY_LOCAL_MACHINE\HARDWARE\DEVICEMAP\KEYBD" Para name = "SpecialEnterTabKey" value = 0 Refer to the <i>MC909X Integrator Guide</i> for instruction on updating the registry using XML Provisioning.

38-Key Alpha/Shifted Numeric Keypad for MC909X-S

The 38-key alpha/shifted numeric keypad contains a **Power** button, application keys, scroll keys and a function key. The keypad is color-coded to indicate the alternate function key (blue) values and the alternate numeric key (orange) values. Note that keypad functions can be changed by an application so the mobile computer's keypad may not function exactly as described. See [Table 2-5 on page 2-13](#) for key and button descriptions and [Table 2-14 on page 2-43](#) for the keypad's special functions.

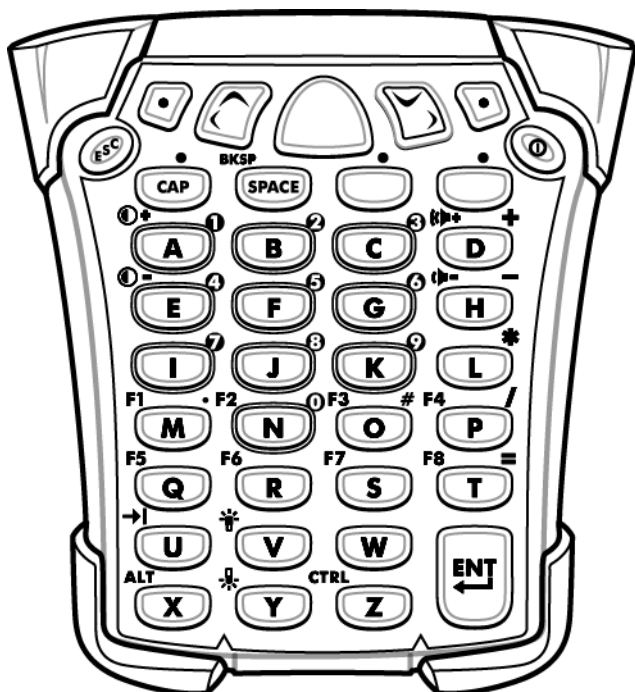

Figure 2-20 38-Key Alpha/Shifted Numeric Keypad for MC909X-S

Table 2-8 38-Key Alpha/Shifted Numeric for MC909X-S Keypad Descriptions















Key	Description
Power (red) 	Turns the mobile computer on and off. Performs a warm boot and a cold boot. See Windows Mobile 5.0 Devices on page 2-50 for information about performing a warm and cold boot.
Green/Red Dot 	MC9094 and MC9097: Green dot: press to display the phone keypad window or to dial a phone number (from the phone keypad window). Red dot: press on phone keypad window to stop dialing or end a call. MC9090: To use a key as an application key (APP key) on the keyboard, a new keyboard remap table must be created and installed. However, the Green/Red dot keys can be remapped as APP keys through the registry. Create an XML Provisioning file with the following entries: Characteristic type = "HKEY_LOCAL_MACHINE\HARDWARE\DEVICEMAP\KEYBD" Parm name = "GreenKeyOverride" value = "xx", where xx is the new APP key code. Parm name = "RedKeyOverride" value = "xx", where xx is the new APP key code. Refer to the <i>MC909X Integrator Guide</i> for instruction on updating the registry using XML Provisioning. This sends an APP key code, instead of their original key codes, when the green or red dot key is pressed.
Scan (yellow) 	Activates the scanner/imager in a scan enabled application.
Scroll Up and Left 	Moves up by default. Use with the orange num-lock key to move left.
Scroll Down and Right 	Moves down by default. Use with the orange num-lock key to move right.
ESC 	Exits the current operation.
CAP 	Use to produce capital alpha characters. The LED above the key lights and the  icon appears at the bottom of the screen.
SPACE 	In default state, produces a space function. Use with the orange num-lock key for the backspace function.

Table 2-8 38-Key Alpha/Shifted Numeric for MC909X-S Keypad Descriptions (Continued)

Key	Description
Num-lock (orange) 	Press and release the orange num-lock key to activate the keypad alternate num-lock functions (shown on the keypad in orange). The LED above the key lights and the  icon appears at the bottom of the screen. Press and release the orange num-lock key again to return to the default keypad functions.
Function (blue) 	Press and release the blue function key to activate the keypad alternate functions (shown on the keypad in blue). The LED above the key lights and the  icon appears at the bottom of the screen. Press and release the blue function key again to return to the normal keypad functions.
Alpha 	Use for alpha characters by default. Use with the orange num-lock key for numeric character values. Use the blue function key for function values.
ENT (Enter) 	Executes a selected item or function. For Windows Mobile 5.0: The default behavior of the ENT (Enter) key sends an extra character, which causes a Microsoft Word or Notes application to exit. To make the applications work properly, create an XML Provisioning file with the following entries: Characteristic type = "HKEY_LOCAL_MACHINE\HARDWARE\DEVICEMAP\KEYBD" Para name = "SpecialEnterTabKey" value = 0 Refer to the <i>MC909X Integrator Guide</i> for instruction on updating the registry using XML Provisioning.

43-Key Keypad for MC909X-G/K

The 43-key keypad contains a **Power** button, application keys, scroll keys and a function key. The keypad is color-coded to indicate the alternate function key (blue) values and the alternate ALPHA key (orange) values. Note that keypad functions can be changed by an application so the mobile computer's keypad may not function exactly as described. See [Table 2-9 on page 2-28](#) for key and button descriptions and [Table 2-14 on page 2-43](#) for the keypad's special functions.

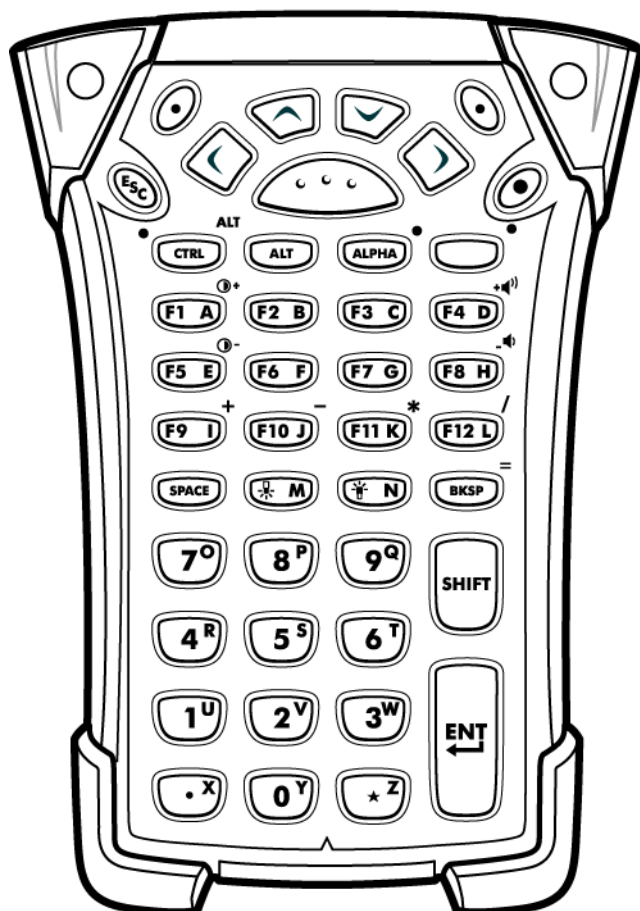

Figure 2-21 43-Key Keypad for MC909X-G/K

Table 2-9 43-Key Keypad Descriptions









Key	Description
Power (red) 	Turns the mobile computer on and off. Performs a warm boot and a cold boot. See Windows Mobile 5.0 Devices on page 2-50 for information about performing a warm and cold boot.
Green/Red Dot 	<p>MC9094 and MC9097: Green dot: press to display the phone keypad window or to dial a phone number (from the phone keypad window). Red dot: press on phone keypad window to stop dialing or end a call.</p> <p>MC9090: To use a key as an application key (APP key) on the keyboard, a new keyboard remap table must be created and installed. However, the Green/Red dot keys can be remapped as APP keys through the registry. Create an XML Provisioning file with the following entries: Characteristic type = "HKEY_LOCAL_MACHINE\HARDWARE\DEVICEMAP\KEYBD" Parm name = "GreenKeyOverride" value = "xx", where xx is the new APP key code. Parm name = "RedKeyOverride" value = "xx", where xx is the new APP key code.</p> <p>Refer to the <i>MC909X Integrator Guide</i> for instruction on updating the registry using XML Provisioning. This sends an APP key code, instead of their original key codes, when the green or red dot key is pressed.</p>
Scan (yellow) 	Activates the scanner/imager in a scan enabled application.
Scroll Up and Down 	Moves up and down from one item to another. Increases/decreases specified values.
Scroll Left and Right 	Moves left and right from one item to another. Increases/decreases specified values.
ESC 	Exits the current operation.
SPACE/BKSP 	Space and backspace functions.
Numeric/Alpha 	Number or alpha value depending on the state of the ALPHA key.

Table 2-9 43-Key Keypad Descriptions (Continued)

















Key	Description
Alpha/Application 	<p>These keys can have an application assigned to the function value and have an alpha value assigned when used with the ALPHA function key.</p> <p>On Windows Mobile 5.0 devices: F6 and F7 keys cannot be remapped and are dedicated by the Operating System to control volume level. When these keys are pressed, Shell.exe traps them and displays the volume adjustment window. To get these keys to an application, call GXOpenInput() at the beginning of the application and call GXCloseInput() at the end of the application. This redirects all of the key events to an application, including the F6 and F7 keys.</p> <p>Note: Other applications cannot receive any key event until GXCloseInput() is called. For example, if the customer is using the APP1 key to run Calc.exe, this is disabled during this period.</p>
Function (blue) 	<p>Press and release the blue function key to activate the keypad alternate functions (shown on the keypad in blue). The LED above the key lights and the  icon appears at the bottom of the screen. Press and release the blue function key again to return to the normal keypad functions.</p>
Control 	<p>Press and release the CTRL key to activate the keypad alternate CTRL functions. The LED above the key lights and the  icon appears on the taskbar on WinCE devices or the  icon appears at the bottom of the screen on Windows Mobile 5.0 devices.</p> <p>Press the Blue key followed by the CTRL key to activate the keypad alternate ALT functions. The ALT icon appears on the taskbar on WinCE devices or the  icon appears at the bottom of the screen on Windows Mobile 5.0 devices.</p>
ALPHA (orange) 	<p>The default keypad mode is the num-lock (number lock) mode. Press the orange ALPHA key to de-activate the num-lock mode and to access the alternate ALPHA characters (shown on the keypad in orange). The LED above the key lights and the  icon appears on the taskbar on WinCE devices or the  icon appears at the bottom of the screen on Windows Mobile 5.0 devices. Press and release the ALPHA key again to return to the normal keypad functions.</p>
Shift 	<p>Press and release the SHIFT key to activate the keypad alternate SHIFT functions. The  icon appears on the taskbar on WinCE devices or the  icon appears at the bottom of the screen on Windows Mobile 5.0 devices. Press and release the SHIFT key again to return to the normal keypad functions.</p> <p>Use with the orange alpha-lock key for alpha character value.</p>

Table 2-9 43-Key Keypad Descriptions (Continued)

Key	Description
Period/Decimal Point 	Produces a period for alpha entries, a decimal point for numeric entries and the alphabetic character X when the ALPHA function key is activated.
Star 	Produces an asterisk and the alphabetic character Z when the ALPHA function key is activated.
Enter 	Executes a selected item or function. For Windows Mobile 5.0: The default behavior of the ENT (Enter) key sends an extra character, which causes a Microsoft Word or Notes application to exit. To make the applications work properly, create an XML Provisioning file with the following entries: Characteristic type = "HKEY_LOCAL_MACHINE\HARDWARE\DEVICEMAP\KEYBD" Para name = "SpecialEnterTabKey" value = 0 Refer to the <i>MC909X Integrator Guide</i> for instruction on updating the registry using XML Provisioning.

53-Key Keypad for MC909X-G/K

There are two physical configurations of the 53-key keypad, however both of the keypads are functionally identical. The 53-key keypad contains a Power button, application keys, scroll keys and function keys. The keypad is color-coded to indicate the alternate function key (blue) values. Note that keypad functions can be changed by an application so the mobile computer's keypad may not function exactly as described. See [Table 2-10 on page 2-32](#) for key and button descriptions and [Table 2-14 on page 2-43](#) for the keypad's special functions.

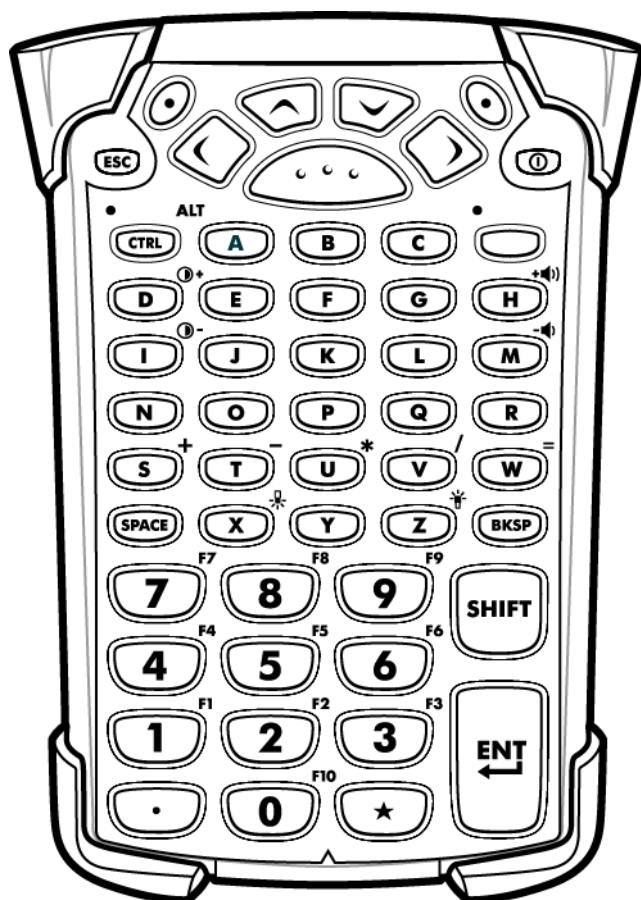

Figure 2-22 53-Key Keypad for MC909X-G/K

Table 2-10 53-Key Descriptions





















Key	Description
Power (red) 	Turns the mobile computer on and off. Performs a warm boot and a cold boot. See Windows Mobile 5.0 Devices on page 2-50 for information about performing a warm and cold boot.
Green/Red Dot 	MC9094 and MC9097: Green dot: press to display the phone keypad window or to dial a phone number (from the phone keypad window). Red dot: press on phone keypad window to stop dialing or end a call. MC9090: To use a key as an application key (APP key) on the keyboard, a new keyboard remap table must be created and installed. However, the Green/Red dot keys can be remapped as APP keys through the registry. Create an XML Provisioning file with the following entries: Characteristic type = "HKEY_LOCAL_MACHINE\HARDWARE\DEVICEMAP\KEYBD" Parm name = "GreenKeyOverride" value = "xx", where xx is the new APP key code. Parm name = "RedKeyOverride" value = "xx", where xx is the new APP key code. Refer to the <i>MC909X Integrator Guide</i> for instruction on updating the registry using XML Provisioning. This sends an APP key code, instead of their original key codes, when the green or red dot key is pressed.
Scan (yellow) 	Activates the scanner/imager in a scan enabled application.
Scroll Up and Down 	Moves up and down from one item to another. Increases/decreases specified values.
Scroll Left and Right 	Moves left and right from one item to another. Increases/decreases specified values.
ESC 	Exits the current operation.
Alpha 	Use the alpha keys for alphabetic characters.
SPACE/BKSP 	Space and backspace functions.

Table 2-10 53-Key Descriptions (Continued)

Key	Description
Numeric/Application 	Numeric value keys - can have applications assigned with function key(s). For Windows Mobile 5.0 devices: F6 and F7 keys cannot be remapped and are dedicated by the Operating System to control volume level. When these keys are pressed, Shell.exe traps them and displays the volume adjustment window. To get these keys to an application, call GXOpenInput() at the beginning of the application and call GXCloseInput() at the end of the application. This redirects all of the key events to an application, including the F6 and F7 keys. Note: Other applications cannot receive any key event until GXCloseInput() is called. For example, if the customer is using the APP1 key to run Calc.exe, this is disabled during this period.
Function (blue) 	Press and release the blue function key to activate the keypad alternate functions (shown on the keypad in blue). The LED above the key lights and the F icon appears on the taskbar on WinCE devices or the  icon appears at the bottom of the screen on Windows Mobile 5.0 devices. Press and release the blue function key again to return to the normal keypad functions.
Control 	Press and release the CTRL key to activate the keypad alternate CTRL functions. The LED above the key lights and the  icon appears on the taskbar on WinCE devices or the  icon appears at the bottom of the screen on Windows Mobile 5.0 devices. Press the Blue key followed by the CTRL key to activate the keypad alternate ALT functions. The ALT icon appears on the taskbar on WinCE devices or the  icon appears at the bottom of the screen on Windows Mobile 5.0 devices.
Shift 	Press and release the SHIFT key to activate the keypad alternate SHIFT functions. The  icon appears on the taskbar on WinCE devices or the  icon appears at the bottom of the screen on Windows Mobile 5.0 devices. Press and release the SHIFT key again to return to the normal keypad functions.
Period/Decimal Point 	Produces a period for alpha entries and a decimal point for numeric entries.
Star 	Produces an asterisk.
Enter 	Executes a selected item or function. For Windows Mobile 5.0 devices: The default behavior of the ENT (Enter) key sends an extra character, which causes a Microsoft Word or Notes application to exit. To make the applications work properly, create an XML Provisioning file with the following entries: Characteristic type = "HKEY_LOCAL_MACHINE\HARDWARE\DEVICEMAP\KEYBD" Para name = "SpecialEnterTabKey" value = 0 Refer to the <i>MC909X Integrator Guide</i> for instruction on updating the registry using XML Provisioning.

3270 Emulator Keypad for MC909X-G/K

There are two physical configurations of the 3270 emulator keypad, however both of the keypads are functionally identical. The 3270 emulator keypad contains a Power button, application keys, scroll keys and a function key. The keypad is color-coded to indicate the alternate function key (blue) values. Note that keypad functions can be changed by an application so the mobile computer's keypad may not function exactly as described. See [Table 2-11 on page 2-35](#) for key and button descriptions and [Table 2-14 on page 2-43](#) for the keypad's special functions.

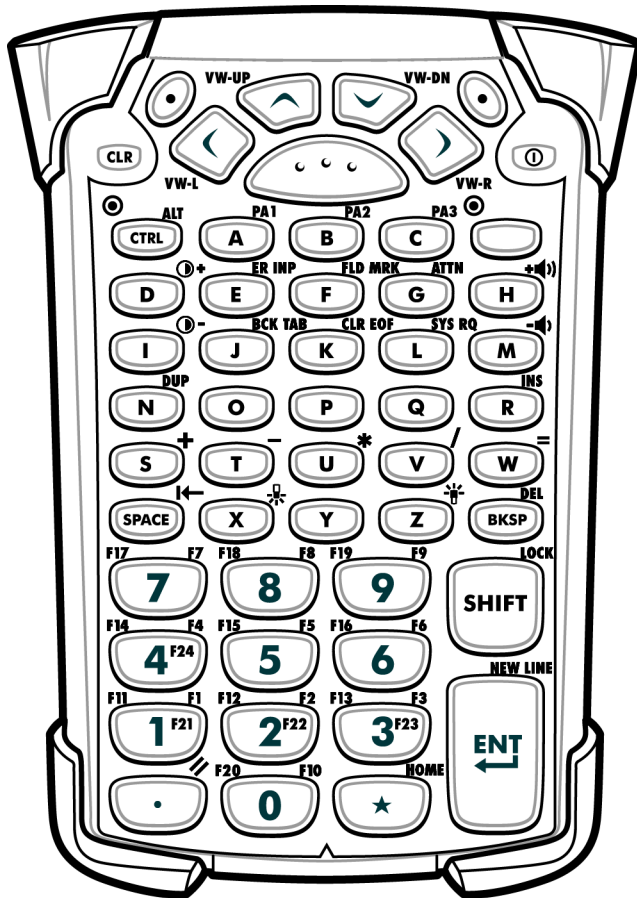

Figure 2-23 3270 Emulator Keypad for MC909X-G/K

- ✓ **NOTE** The 3270 emulator keypad is only used when the mobile computer is running the 3270 emulation software. When the mobile computer is not running the 3270 emulation software, the 3270 keypad functions are the same as a 53-key keypad.

Table 2-11 3270 Emulator Descriptions

















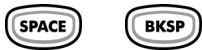



Key	Description
Power (red) 	Turns the mobile computer on and off. Performs a warm boot and a cold boot. See Windows Mobile 5.0 Devices on page 2-50 for information about performing a warm and cold boot.
Green/Red Dot 	To use a key as an application key (APP key) on the keyboard, a new keyboard remap table must be created and installed. However, the Green/Red dot keys can be remapped as APP keys through the registry. Create an XML Provisioning file with the following entries: Characteristic type = "HKEY_LOCAL_MACHINE\HARDWARE\DEVICEMAP\KEYBD" Parm name = "GreenKeyOverride" value = "xx", where xx is the new APP key code. Parm name = "RedKeyOverride" value = "xx", where xx is the new APP key code. Refer to the <i>MC909X Integrator Guide</i> for instruction on updating the registry using XML Provisioning. This sends an APP key code, instead of their original key codes, when the green or red dot key is pressed.
Scan (yellow) 	Activates the scanner/imager in a scan enabled application.
Scroll Up and Down 	Moves up and down from one item to another. Increases/decreases specified values.
Scroll Left and Right 	Moves left and right from one item to another. Increases/decreases specified values.
CLR 	Exits the current operation.
Alpha 	Use the alpha keys for alphabetic characters.
SPACE/BKSP 	Space and backspace functions.

Table 2-11 3270 Emulator Descriptions (Continued)

Key	Description
<p>Application</p> 	<p>These keys can be assigned to an application.</p> <p>On Windows Mobile 5.0 devices: F6 and F7 keys cannot be remapped and are dedicated by the Operating System to control volume level. When these keys are pressed, Shell.exe traps them and displays the volume adjustment window. To get these keys to an application, call GXOpenInput() at the beginning of the application and call GXCLOSEInput() at the end of the application. This redirects all of the key events to an application, including the F6 and F7 keys.</p> <p>Note: Other applications cannot receive any key event until GXCLOSEInput() is called. For example, if the customer is using the APP1 key to run Calc.exe, this is disabled during this period.</p>
<p>Function (blue)</p> 	<p>Press and release the blue function key to activate the keypad alternate functions (shown on the keypad in blue). The LED above the key lights and the F icon appears on the taskbar on WinCE devices or the  icon appears at the bottom of the screen on Windows Mobile 5.0 devices. Press and release the blue function key again to return to the normal keypad functions.</p>
<p>Control</p> 	<p>Press and release the CTRL key to activate the keypad alternate CTRL functions. The LED above the key lights and the  icon appears on the taskbar on WinCE devices or the  icon appears at the bottom of the screen on Windows Mobile 5.0 devices. Press the Blue key followed by the CTRL key to activate the keypad alternate ALT functions. The ALT icon appears on the taskbar on WinCE devices or the  icon appears at the bottom of the screen on Windows Mobile 5.0 devices.</p>
<p>Shift</p> 	<p>Press and release the SHIFT key to activate the keypad alternate SHIFT functions. The  icon appears on the taskbar on WinCE devices or the  icon appears at the bottom of the screen on Windows Mobile 5.0 devices. Press and release the SHIFT key again to return to the normal keypad functions.</p>
<p>Period/Decimal Point</p> 	<p>Produces a period for alpha entries and a decimal point for numeric entries.</p>
<p>Star</p> 	<p>Produces an asterisk.</p>
<p>Enter</p> 	<p>Executes a selected item or function.</p> <p>For Windows Mobile 5.0:</p> <p>The default behavior of the ENT (Enter) key sends an extra character, which causes a Microsoft Word or Notes application to exit. To make the applications work properly, create an XML Provisioning file with the following entries:</p> <p>Characteristic type = "HKEY_LOCAL_MACHINE\HARDWARE\DEVICEMAP\KEYBD"</p> <p>Para name = "SpecialEnterTabKey" value = 0</p> <p>Refer to the <i>MC909X Integrator Guide</i> for instruction on updating the registry using XML Provisioning.</p>

5250 Emulator Keypad for MC909X-G/K

There are two physical configurations of the 5250 emulator keypad, however both of the keypads are functionally identical. The 5250 emulator keypad contains a Power button, application keys, scroll keys and a function key. The keypad is color-coded to indicate the alternate function key (blue) values. Note that keypad functions can be changed by an application so the mobile computer's keypad may not function exactly as described. See [Table 2-12 on page 2-38](#) for key and button descriptions and [Table 2-14 on page 2-43](#) for the keypad's special functions.

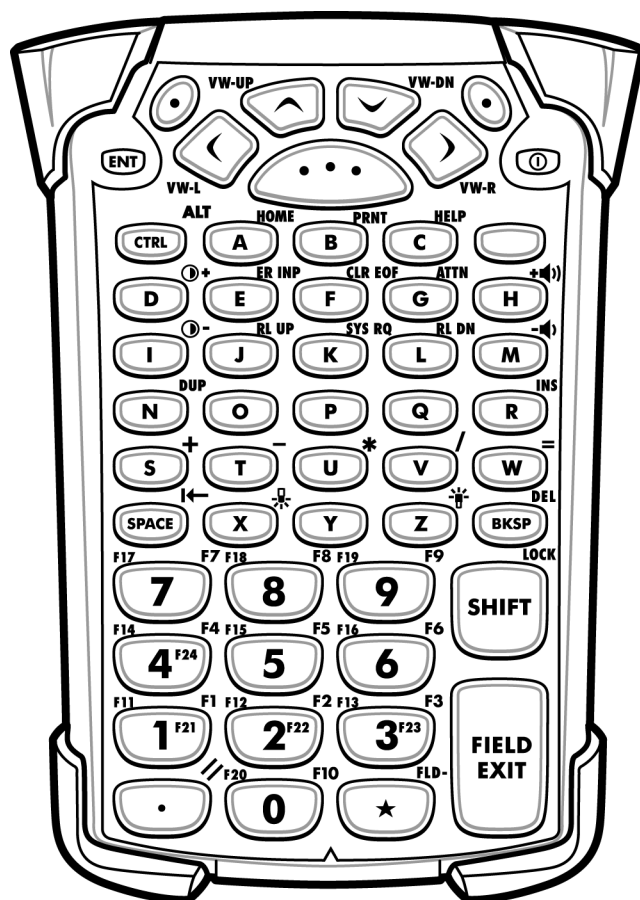

Figure 2-24 5250 Emulator Keypad for MC909X-G/K

- ✓ **NOTE** The 5250 emulator configuration is only used when the mobile computer is running the 5250 emulation software. When the mobile computer is not running the 5250 emulation software, the 5250 keypad functions are the same as a 53-key keypad.

Table 2-12 5250 Emulator Descriptions

















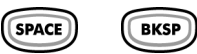



Key	Description
Power (red) 	Turns the mobile computer on and off. Performs a warm boot and a cold boot. See Windows Mobile 5.0 Devices on page 2-50 for information about performing a warm and cold boot.
Green/Red Dot 	To use a key as an application key (APP key) on the keyboard, a new keyboard remap table must be created and installed. However, the Green/Red dot keys can be remapped as APP keys through the registry. Create an XML Provisioning file with the following entries: Characteristic type = "HKEY_LOCAL_MACHINE\HARDWARE\DEVICEMAP\KEYBD" Parm name = "GreenKeyOverride" value = "xx", where xx is the new APP key code. Parm name = "RedKeyOverride" value = "xx", where xx is the new APP key code. Refer to the <i>MC909X Integrator Guide</i> for instruction on updating the registry using XML Provisioning. This sends an APP key code, instead of their original key codes, when the green or red dot key is pressed.
Scan (yellow) 	Activates the scanner/imager in a scan enabled application.
Scroll Up and Down 	Moves up and down from one item to another.
Scroll Left and Right 	Moves left and right from one item to another.
ENT 	Exits the current operation.
Alpha 	Use the alpha keys for alphabetic characters.
SPACE/BKSP 	Space and backspace functions.

Table 2-12 5250 Emulator Descriptions (Continued)

Key	Description
Application 	These keys can be assigned to an application. On Windows Mobile 5.0 devices: F6 and F7 keys cannot be remapped and are dedicated by the Operating System to control volume level. When these keys are pressed, Shell.exe traps them and displays the volume adjustment window. To get these keys to an application, call GXOpenInput() at the beginning of the application and call GXClosInput() at the end of the application. This redirects all of the key events to an application, including the F6 and F7 keys. Note: Other applications cannot receive any key event until GXClosInput() is called. For example, if the customer is using the APP1 key to run Calc.exe, this is disabled during this period.
Function (blue) 	Press and release the blue function key to activate the keypad alternate functions (shown on the keypad in blue). The LED above the key lights and the F icon appears on the taskbar on WinCE devices or the  icon appears at the bottom of the screen on Windows Mobile 5.0 devices. Press and release the blue function key again to return to the normal keypad functions.
Control 	Press and release the CTRL key to activate the keypad alternate CTRL functions. The LED above the key lights and the  icon appears on the taskbar on WinCE devices or the  icon appears at the bottom of the screen on Windows Mobile 5.0 devices. Press the Blue key followed by the CTRL key to activate the keypad alternate ALT functions. The ALT icon appears on the taskbar on WinCE devices or the  icon appears at the bottom of the screen on Windows Mobile 5.0 devices.
Shift 	Press and release the SHIFT key to activate the keypad alternate SHIFT functions. The  icon appears on the taskbar on WinCE devices or the  icon appears at the bottom of the screen on Windows Mobile 5.0 devices. Press and release the SHIFT key again to return to the normal keypad functions.
Period/Decimal Point 	Produces a period for alpha entries and a decimal point for numeric entries.
Star 	Produces an asterisk.
Enter 	Executes a selected item or function. For Windows Mobile 5.0: The default behavior of the Enter key sends an extra character, which causes a Microsoft Word or Notes application to exit. To make the applications work properly, create an XML Provisioning file with the following entries: Characteristic type = "HKEY_LOCAL_MACHINE\HARDWARE\DEVICEMAP\KEYBD" Para name = "SpecialEnterTabKey" value = 0 Refer to the <i>MC909X Integrator Guide</i> for instruction on updating the registry using XML Provisioning.

VT Emulator Keypad

The VT emulator keypad contains a Power button, application keys, scroll keys and a function key. The keypad is color-coded to indicate the alternate function key (blue) values. Note that keypad functions can be changed by an application so the mobile computer's keypad may not function exactly as described. See [Table 2-13 on page 2-41](#) for key and button descriptions and [Table 2-14 on page 2-43](#) for the keypad's special functions.

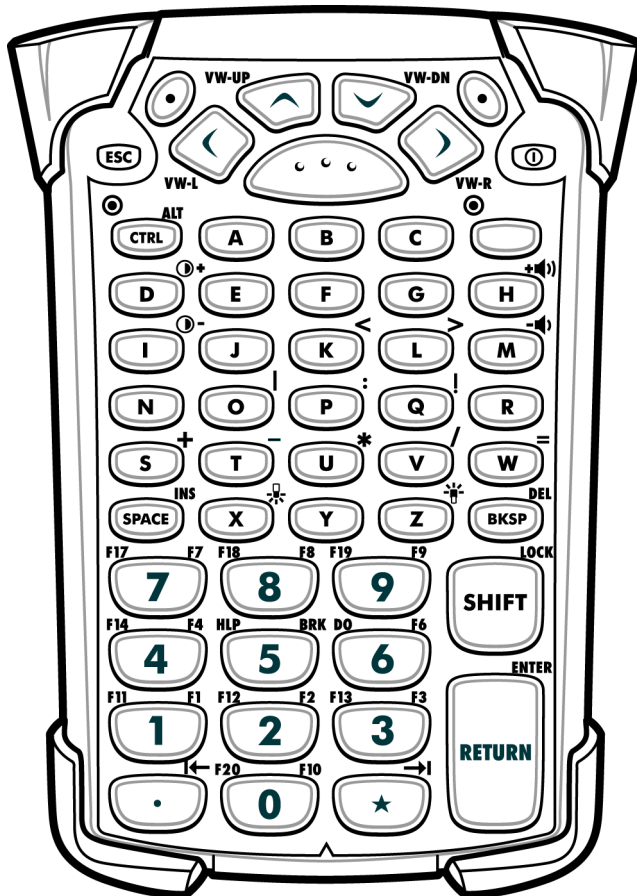

Figure 2-25 VT Emulator Keypad

- ✓ **NOTE** The VT emulator configuration is only used when the mobile computer is running the VT emulation software. When the mobile computer is not running the VT emulation software, the VT keypad functions are the same as a 53-key keypad.

Table 2-13 VT Emulator Descriptions

















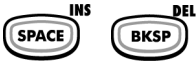



Key	Description
Power (red) 	Turns the mobile computer on and off. Performs a warm boot and a cold boot. See Windows Mobile 5.0 Devices on page 2-50 for information about performing a warm and cold boot.
Green/Red Dot 	To use a key as an application key (APP key) on the keyboard, a new keyboard remap table must be created and installed. However, the Green/Red dot keys can be remapped as APP keys through the registry. Create an XML Provisioning file with the following entries: Characteristic type = "HKEY_LOCAL_MACHINE\HARDWARE\DEVICEMAP\KEYBD" Parm name = "GreenKeyOverride" value = "xx", where xx is the new APP key code. Parm name = "RedKeyOverride" value = "xx", where xx is the new APP key code. Refer to the <i>MC909X Integrator Guide</i> for instruction on updating the registry using XML Provisioning. This sends an APP key code, instead of their original key codes, when the green or red dot key is pressed.
Scan (yellow) 	Activates the scanner/imager in a scan enabled application.
Scroll Up and Down 	Moves up and down from one item to another.
Scroll Left and Right 	Moves left and right from one item to another.
ESC 	Exits the current operation.
Alpha 	Use the alpha keys for alphabetic characters.
SPACE/BKSP 	Space and backspace functions.











Table 2-13 VT Emulator Descriptions (Continued)

Key	Description
Application 	<p>These keys can be assigned to an application.</p> <p>F6 and F7 keys cannot be remapped and are dedicated by the Operating System to control volume level. When these keys are pressed, Shell.exe traps them and displays the volume adjustment window. To get these keys to an application, call GXOpenInput() at the beginning of the application and call GXCloseInput() at the end of the application. This redirects all of the key events to an application, including the F6 and F7 keys.</p> <p>Note: Other applications cannot receive any key event until GXCloseInput() is called. For example, if the customer is using the APP1 key to run Calc.exe, this is disabled during this period.</p>
Function (blue) 	<p>Press and release the blue function key to activate the keypad alternate functions (shown on the keypad in blue). The LED above the key lights and the F icon appears on the taskbar on WinCE devices or the  icon appears at the bottom of the screen on Windows Mobile 5.0 devices. Press and release the blue function key again to return to the normal keypad functions.</p>
Control 	<p>Press and release the CTRL key to activate the keypad alternate CTRL functions. The LED above the key lights and the  icon appears on the taskbar on WinCE devices or the  icon appears at the bottom of the screen on Windows Mobile 5.0 devices. Press the Blue key followed by the CTRL key to activate the keypad alternate ALT functions. The ALT icon appears on the taskbar on WinCE devices or the  icon appears at the bottom of the screen on Windows Mobile 5.0 devices.</p>
Shift 	<p>Press and release the SHIFT key to activate the keypad alternate SHIFT functions. The  icon appears on the taskbar on WinCE devices or the  icon appears at the bottom of the screen on Windows Mobile 5.0 devices. Press and release the SHIFT key again to return to the normal keypad functions.</p>
Period/Decimal Point 	<p>Produces a period for alpha entries and decimal point for numeric entries.</p>
Star 	<p>Produces an asterisk.</p>
Enter 	<p>Executes a selected item or function.</p> <p>For Windows Mobile 5.0:</p> <p>The default behavior of the RETURN key sends an extra character, which causes a Microsoft Word or Notes application to exit. To make the applications work properly, create an XML Provisioning file with the following entries:</p> <p>Characteristic type = "HKEY_LOCAL_MACHINE\HARDWARE\DEVICEMAP\KEYBD"</p> <p>Para name = "SpecialEnterTabKey" value = 0</p> <p>Refer to the <i>MC909X Integrator Guide</i> for instruction on updating the registry using XML Provisioning.</p>

Keypad Special Functions

The keypad special functions are color coded on the keypads. For example, on the 53-key keypad, the display backlight icon is blue indicating that the blue function key must be selected first to access the display backlight. On the 43-key keypad, the display backlight icon is white indicating that the display backlight is the default value for that key.

Table 2-14 Keypad Special Functions

Icon	28-Key Keypad	33-Key Keypad	38-Key Alpha/Shifted Numeric Keypad	38-Key Numeric/Function Keypad	43-Key Keypad	53-Key, 3270, 5250, VT Keypad	Special Function
	Blue key + #	Blue key + 7	Blue key + V	 key	 key	Blue key + Z	Turns on and off the display backlight.
	Blue key + 0	Blue key + 4	Blue key + Y	 key	 key	Blue key + X	Turns on and off the keypad backlight.
	Blue key + 1	Blue key + 8	Blue key + A	Blue key + F1	Blue key + F1	Blue key + D	Monochrome units: Increases display contrast. Color units: Increases display backlight intensity.
	Blue key + 4	Blue key + 5	Blue key + E	Blue key + F5	Blue key + F5	Blue key + I	Monochrome units: Decreases display contrast. Color units: Increases display backlight intensity.
	Blue key + 3	Blue key + 9	Blue key + D	Blue key + F4	Blue key + F4	Blue key + H	Increases scan decode beeper volume.
	Blue key + 6	Blue key + 6	Blue key + H	Blue key + F8	Blue key + F8	Blue key + M	Decreases scan decode beeper volume.
ALT	Blue key + CTRL	Blue key + CTRL	Blue key + X	Blue key + CTRL	Blue key + CTRL	Blue key + CTRL	Enables Alt keypad functions.
	Not available	Not available	Blue key + U	Not available	Not available	Not available	Sends TAB character (forward tab).



NOTE Use of display and keypad backlighting can significantly reduce battery life. Mobile computers with color screens do not have contrast settings.

Entering Data

When entering data on the keypad, use either the single-hand method or the two-hand method as shown in [Figure 2-26](#).

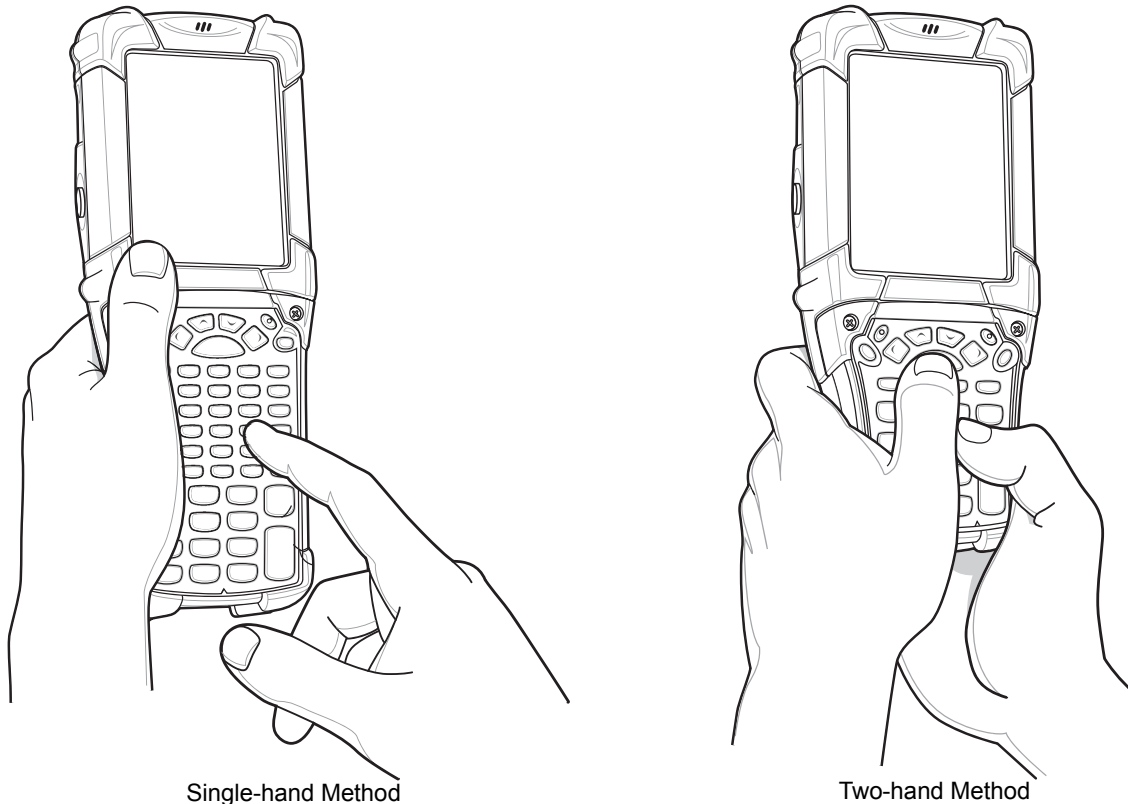

Figure 2-26 *Entering Data on the Keypad*

Using the Power Button

Press the red Power button to turn the mobile computer screen on and off (suspend mode). The mobile computer is on when the screen is on and the mobile computer is in suspend mode when the screen is off. For more information, see [Starting the Mobile Computer on page 1-10](#).

The Power button is also used to reset the mobile computer by performing a warm or cold boot.

- On Windows CE 5.0
 - Warm Boot (Soft Reset) - Resets the mobile computer.
 - Cold Boot (Hard Reset) - Resets the mobile computer, removes all added applications and restores all factory default settings.

- On Windows Mobile 5.0
 - Warm Boot (Soft Reset) - Resets the mobile computer. Operating system and all applications are restarted. File storage is preserved.
 - Cold Boot (Hard Reset) - Resets the mobile computer Operating system and all applications are restarted. File storage is preserved. Real-Time Clock (RTC) is reset. Normally only used when a Warm Boot does not initiate.
- ✓ **NOTE** Applications that are added to the Application folder are not removed when a cold boot is performed. The Application folder is in flash memory.

For information about booting the mobile computer, see [Windows Mobile 5.0 Devices on page 2-50](#).

Using a Wired Headset

You can use a stereo headset for audio communication when an audio enabled application is used. To use a headset, plug the headset jack into the audio connector on the side of the mobile computer. Ensure that the mobile computer's volume is set appropriately before putting the headset on. When a headset is plugged into the jack, the speakerphone is muted.

For WWAN-enabled mobile computers, Zebra recommends a 2.5mm jack headset, p/n 50-11300-050.

- ✓ **NOTE** The MC9094 and MC9097 does not support headsets with buttons used to answer or hang-up a call. Use the green dot or red dot keys on the keypad.

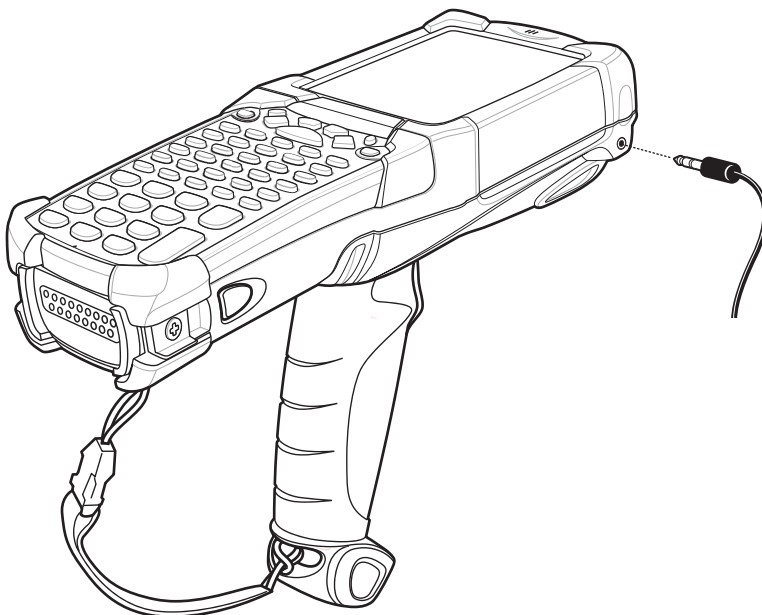

Figure 2-27 Using a Headset (MC9090-G Shown)

Using a Bluetooth Headset

You can use a Bluetooth headset for audio communication when an audio enabled application is used. See [Chapter 3, Using Bluetooth](#) for information on connecting a Bluetooth device to the mobile computer. Ensure that the mobile computer's volume is set appropriately before putting the headset on. When a Bluetooth headset is connected the speakerphone is muted.

✓ **NOTE** The MC9094 and MC9097 does not support headsets with buttons used to answer or hang-up a call. Use the green dot or red dot keys on the keypad.

If the mobile computer goes into suspend mode the Bluetooth connection is disabled and the mobile computer automatically switches to speakerphone mode.

Data Capture

Mobile computers with an integrated laser scanner allow you to collect data by scanning one dimensional bar codes.

Mobile computers with an integrated imager allow you to collect data by decoding one dimensional bar codes (including RSS) and two dimensional bar codes (including PDF417 and DataMatrix), and capture and download images to a host for a variety of imaging applications.

Laser Scanning

Mobile computers with an integrated laser scanner have the following features:

- Reading of a variety of bar code symbologies, including the most popular linear, postal, and 1-D code types.
- Advanced intuitive laser aiming for easy point-and-shoot operation.

Imaging

Mobile computers with an integrated imager have the following features:

- Omnidirectional reading of a variety of bar code symbologies, including the most popular linear, postal, PDF417 and 2-D matrix code types.
- The ability to capture and download images to a host for a variety of imaging applications.
- Advanced intuitive laser aiming for easy point-and-shoot operation.

The imager uses digital camera technology to take a digital picture of a bar code, stores the resulting image in its memory and executes state-of-the-art software decoding algorithms to extract the data from the image.

Aiming the Imager

The mobile computer's integrated imager projects a laser aiming pattern (field of view) similar to those used on cameras. The aiming pattern is used to position the bar code or object within the field of view.

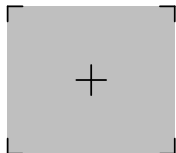

Figure 2-28 *Laser Aiming Pattern (Field of View)*

Operational Modes

Mobile computers with an integrated imager have three modes of operation: Decode Mode, Pick List Mode and Image Capture Mode. All modes are activated by pulling the trigger or pressing the Scan button.

Decode Mode

This mode allows the user to decode a bar code when a single bar code is in the mobile computer's field of view. In this mode the Imager attempts to locate and decode enabled bar codes within its field of view. The Imager remains in this mode as long as the trigger is pulled, or until a bar code is decoded.

Pick List Mode

Pick List mode allows the user to selectively decode a bar code when more than one bar code is in the mobile computer's field of view. By moving the aiming crosshair over the wanted bar code the user can selectively read only the required bar code. This feature is particularly valued for pick lists containing multiple bar codes and manufacturing or transport labels containing more than one bar code type (either 1D or 2D).

Image Capture Mode

This mode allows the user to capture an image within the mobile computer's field of view. The user can use the mobile computer to capture signatures or images of items like damaged boxes.

Scanning Considerations

Typically, scanning is a simple matter of aim, scan/decode and a few quick trial efforts master it. However, two important considerations can be used to optimize any scanning performance:

- Range

Any scanning device decodes well over a particular working range — minimum and maximum distances from the bar code. This range varies according to bar code density and scanning device optics.

Scanning within range brings quick and constant decodes; scanning too close or too far away prevents decodes. Move the scanner closer and further away to find the right working range for the bar codes being scanned. However, the situation is complicated by the availability of various integrated scanning modules. The best way to specify the appropriate working range per bar code density is through a chart called a decode zone for each scan module. A decode zone simply plots working range as a function of minimum element widths of bar code symbols.

- Angle

Scanning angle is important for promoting quick decodes. When laser beams reflect directly back into the scanner from the bar code, this specular reflection can “blind” the scanner.

To avoid this, scan the bar code so that the beam does not bounce directly back. But don't scan at too sharp an angle; the scanner needs to collect scattered reflections from the scan to make a successful decode. Practice quickly shows what tolerances to work within.



NOTE Contact the Zebra Support Center if chronic scanning difficulties develop. Decoding of properly printed bar codes should be quick and effortless.

Scanning Bar Codes

1. Ensure that a scan enabled application is loaded on the mobile computer.
2. Aim the scan exit window at the bar code.
3. Pull the trigger.
 - For mobile computers with a laser scanner, ensure the red scan beam covers the entire bar code. The red scan LED lights to indicate that the laser is on. The green scan LED lights and an audible beep sounds, by default, to indicate the bar code was decoded successfully.

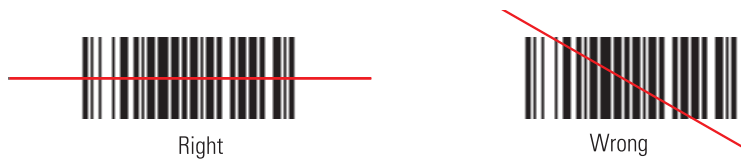

Figure 2-29 Laser Scanner Aiming Pattern

- For mobile computers with an imager, place the bar code in any orientation within the aiming pattern. Ensure the entire symbol is within the rectangular area formed by the brackets in the aiming pattern. The red laser aiming pattern turns on to assist in aiming. If necessary, the mobile computer turns on its red LED to illuminate the target bar code. The green scan LED lights and an audible beep sounds, by default, to indicate the bar code was decoded successfully. Note that when the mobile computer is in Pick List Mode, the bar code is not decoded until the crosshair is touching the bar code.

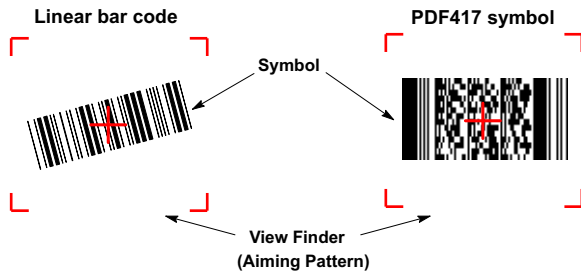

Figure 2-30 Bar Code Centered in Aiming Pattern



Figure 2-31 Bar Code Not Centered in Aiming Pattern

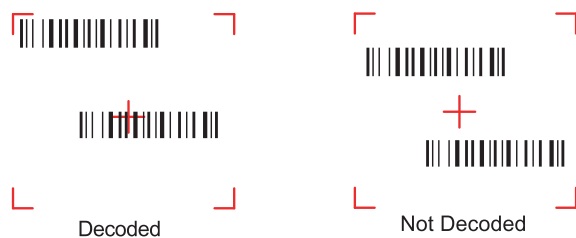

Figure 2-32 Pick List Mode with Multiple Bar Codes in Aiming Pattern

4. Release the trigger.

✓ **NOTE** Imager decoding usually occurs instantaneously. The mobile computer repeats the steps required to take a digital picture (image) of a poor or difficult bar code, as long as the trigger remains pulled.

Scanning Tips

Optimal scanning distance varies with bar code density and scanner optics.

- Hold the scanner farther away for larger symbols.
- Move the scanner closer for symbols with bars that are close together.

✓ **NOTE** Scanning procedures depend on the application and mobile computer configuration. An application may use different scanning procedures from the one listed above.

Scan LED Indicator

The Indicator LED bar on the mobile computer provides a visual indication of the scan status.

Table 2-15 Scan LED Indicators

LED Status	Indication
Off	Not scanning.
Solid Red	Laser enabled, scanning/imaging in process.
Solid Green	Successful decode.

Resetting the Mobile Computer

Windows CE 5.0 Devices

There are two reset functions, warm boot and cold boot. A warm boot restarts the mobile computer by closing all running programs.

A cold boot also restarts the mobile computer, but erases all stored records and entries in RAM. Data saved in flash memory or a memory card is not lost. In addition it returns formats, preferences and other settings to the factory default settings.

Perform a warm boot first. This restarts the mobile computer and saves all *stored* records and entries. If the mobile computer still does not respond, perform a cold boot.

Performing a Warm Boot

Hold down the **Power** button for approximately five seconds. As soon as the mobile computer starts to perform a warm boot release the **Power** button.

Performing a Cold Boot

A cold boot restarts the mobile computer and erases all user stored records and entries that are not saved in flash memory (Application and Platform folders) or a memory card. *Never perform a cold boot unless a warm boot does not solve the problem.*



CAUTION Do not hold down any key, other than the **Power** button during a reset. Performing a cold boot restores formats, preferences and other settings to the default settings.



NOTE Any data previously synchronized with a computer can be restored during the next ActiveSync operation.

To perform a cold boot:

1. Press the primary battery release on the mobile computer to partially eject the battery from the mobile computer.
2. While the battery is partially released, simultaneously press and release the handle trigger and the **Power** button.
3. Push the battery to fully re-insert it in the mobile computer. One audible click can be heard as the battery is fully inserted.
4. The mobile computer initializes.
5. Calibrate the screen. See [Calibrating the Screen on page 1-10](#) to calibrate the mobile computer screen.

Windows Mobile 5.0 Devices

There are two reset functions, warm boot and cold boot.

- A warm boot restarts the mobile computer and closes all running programs.
- A cold boot also restarts the mobile computer and closes all running programs but also resets the Real-Time-Clock (RTC).

Data saved in flash memory or a memory card is not lost. Perform a warm boot first. This restarts the mobile computer and saves all *stored* records and entries. If the mobile computer still does not respond, perform a cold boot.

Performing a Warm Boot

Hold down the Power button for approximately five seconds. As soon as the mobile computer starts to perform a warm boot release the **Power** button.

Performing a Cold Boot

A cold boot restarts the mobile computer. The operating system and all applications are restarted. File storage is preserved. The Real-Time-Clock (RTC) resets. *Only perform a cold boot if a warm boot does not solve the problem.*

To perform a cold boot:

1. Press the primary battery release on the mobile computer to partially eject the battery from the mobile computer.

2. On an MC9090-G, while the battery is partially released, simultaneously press and release the trigger and the **Power** button.
3. On an MC-909X-K or MC909X-S, while the battery is partially released, simultaneously press and release the left scan button and the **Power** button.
4. Push the battery to fully re-insert it in the mobile computer. One audible click can be heard as the battery is fully inserted.
5. The mobile computer initializes.

Waking the Mobile Computer

The wakeup conditions define what actions wakeup the mobile computer. These settings are configurable and the factory default settings shown in [Table 2-16](#) are subject to change/update.

Table 2-16 *Wakeup Conditions (Default Settings)*

Status	Description	Conditions for Wakeup
Power Off	When the mobile computer is set to the suspend mode by pressing Power , these actions wake the mobile computer.	1. Power button is pressed.
		2. AC power added or removed.
		3. Cradle/cable connect or disconnect.
		Key or scan button is pressed.
Auto Off	When the mobile computer goes into suspend mode by an automatic power-off function, these actions wake the mobile computer.	Real Time Clock set to wake up.
		Incoming phone call (MC9094 and MC9097 only)
		1. Power button is pressed.
		2. AC power added or removed.
		3. Cradle/cable connect or disconnect.
		Key or scan button is pressed.
		Real Time Clock set to wake up.
		Incoming phone call (MC9094 and MC9097 only).

Chapter 3 Using Bluetooth

Introduction

Bluetooth-equipped devices can communicate without wires, using frequency-hopping spread spectrum (FHSS) RF to transmit and receive data in the 2.4 GHz Industry Scientific and Medical (ISM) band (802.15.1). Bluetooth wireless technology is specifically designed for short-range (30 feet/10 meters) communications and low power consumption.

Mobile computers with Bluetooth capabilities can exchange information (e.g., files, appointments and tasks) with other Bluetooth enabled devices such as phones, printers, access points and other mobile computers. In addition, a dial-up modem connection can be created between the Bluetooth mobile computer and a Bluetooth enabled phone. The Bluetooth phone can then be used as a modem.

Zebra mobile computers with Bluetooth technology use the StoneStreet One Bluetooth stack. To program Bluetooth within the mobile computer refer to the StoneStreet One SDK.

Adaptive Frequency Hopping

Adaptive Frequency Hopping (AFH) is a method of avoiding fixed frequency interferers. AFH can be used with Bluetooth voice. All devices in the piconet (Bluetooth network) must be AFH-capable in order for AFH to work. There is no AFH when connecting and discovering devices. Avoid making Bluetooth connections and discoveries during critical 802.11b communications. AFH for Bluetooth can be broken-down into four main sections:

- Channel Classification - A method of detecting an interference on a channel-by-channel basis, or pre-defined channel mask.
- Link Management - Coordinates and distributes the AFH information to the rest of the Bluetooth network.
- Hop Sequence Modification - Avoids the interference by selectively reducing the number of hopping channels.
- Channel Maintenance - A method for periodically re-evaluating the channels.

When AFH is enabled, the Bluetooth radio “hops-around” (instead of through) the 802.11b high-rate channels. AFH coexistence allows Zebra mobile computers to operate in any infrastructure. AFH is always enabled in the MC909X.

The Bluetooth radio in this mobile computer operates as a Class 2 device power class. The maximum output power is 2.5mW and the expected range is up to 32.8 feet (10 meters). A definitive definition of ranges based on power class is difficult to obtain due to power and device differences, and whether one measures open space or closed office space.

✓ **NOTE** It is not recommended to perform Bluetooth wireless technology inquiry when high rate 802.11b operation is required.

Security

The current Bluetooth specification defines security at the link level. Application-level security is not specified. This allows application developers to define security mechanisms tailored to their specific need. Link-level security is really between devices not users, while application-level security can be implemented on a per-user basis. The Bluetooth specification defines security algorithms and procedures needed to authenticate devices, and if needed, encrypt the data flowing on the link between the devices. Device authentication is a mandatory feature of Bluetooth while link encryption is optional.

Pairing of Bluetooth devices is accomplished by creating an initialization key that is used to authenticate the devices and create a link key for them. Entering a common PIN number in the devices being paired generates the initialization key. The PIN number is never sent over the air. By default, the Bluetooth stack responds with no key when a key is requested (it is up to user to respond to the key request event). Authentication of Bluetooth devices is based-upon a challenge-response transaction. Bluetooth allows for a PIN number or passkey that is used to create other 128-bit keys used for security and encryption. The encryption key is derived from the link key used to authenticate the pairing devices. Also worthy of note is the limited range and fast frequency hopping of the Bluetooth radios that makes long-distance eavesdropping difficult.

It is recommended:

- Perform pairing in a secure environment
- Keep PIN codes private and don't store the PIN codes in the mobile computer
- Implement application-level security.

Turning the Bluetooth Radio Mode On and Off

Turn off the Bluetooth radio to save power or if entering an area with radio restrictions (e.g., an airplane). When the radio is off, the mobile computer can not be seen or connected to by other Bluetooth devices. Turn on the Bluetooth radio to exchange information with other Bluetooth devices (within range). Communicate only with Bluetooth radios in close proximity.

✓ **NOTE** To achieve the best battery life in mobile computers with multiple radios, turn off the radios that are not being used.

Disabling Bluetooth

To disable Bluetooth, tap **Bluetooth** icon > **Disable Bluetooth**. The **Bluetooth** icon changes to indicate that Bluetooth is disabled. An exclamation point appears with the icon.



Figure 3-1 *Disable Bluetooth*

Enabling Bluetooth

To enable Bluetooth, tap **Bluetooth** icon > **Enable Bluetooth**. The **Bluetooth** icon changes to indicate that Bluetooth is enabled.

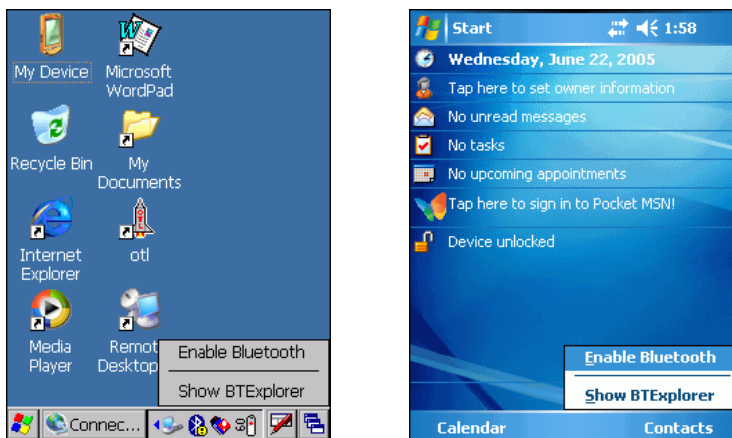

Figure 3-2 *Enable Bluetooth*

Bluetooth Power States

Cold Boot

When a cold boot is performed on the mobile computer, Bluetooth turns off. It is normal to see the **Bluetooth** icon appear and disappear, as well as a wait cursor, when initialization proceeds in all modes.

Warm Boot

When a warm boot is performed on the mobile computer, Bluetooth returns to the disabled state (off).

Suspend

When the mobile computer suspends, Bluetooth turns off.

- ✓ **NOTE** When the mobile computer is placed in suspend mode, the Bluetooth radio mode powers off and the piconet (Bluetooth connection) is dropped. When the mobile computer resumes, it could take up to 10 seconds for the Bluetooth radio driver to re-initialize the radio.



Resume

When the mobile computer resumes, Bluetooth turns on if it was on prior to suspend. Note that any Bluetooth connection that was dropped during a suspend needs to be reconnected after a resume.

Bluetooth Profiles

The mobile computer is loaded with a number of Bluetooth services profiles. These profiles can be loaded or removed from memory. If a profile is not used, it can be removed to save memory. To load or remove profiles:

- ✓ **NOTE** On Windows CE 5.0 devices, BTE Explorer must be disabled prior to changing profiles. Windows Mobile 5.0 devices do not require disabling BTE Explorer.

1. On Windows CE 5.0 devices only, if **BTE Explorer** is running, tap  > **Disable Bluetooth**.
2. Tap  > **Programs** > **BTProfileSelector**. The **ProfileSelector** window appears.

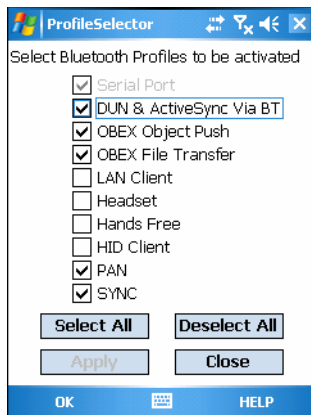



Figure 3-3 Bluetooth Profile Selector Window

3. Tap a check box next to the profile to load (activate).
The Serial Port profile is always active and cannot be removed.
4. Tap **Select All** to select all profiles or tap **Deselect All** to deselect all profiles.
5. Tap **Apply** to activate the profiles and then **Close** to exit the application.
6. On Windows CE 5.0 devices only, tap  > **Enable Bluetooth** to enable **BTE Explorer** application.

See [Services Tab on page 3-22](#) for more information on selecting services.

Modes

The BTEplorer application has two mode for managing Bluetooth connections: Wizard Mode and Explorer Mode. The Wizard Mode is for novice Bluetooth users and the Explorer Mode is for experienced Bluetooth users.

Wizard Mode

Wizard Mode provides a simple step by step process for discovering and connecting to Bluetooth devices. The wizard takes you through the entire process.

✓ **NOTE** When switching between Wizard Mode and Explorer Mode, all active connections are closed.

The following steps provide an example for using the Wizard to services for remote devices.

1. Tap the **Bluetooth** icon and select **Show BTEplorer**. The **BTEplorer** window appears.
2. Tap **File > New Connection**. The **New Connection Wizard** window appears.

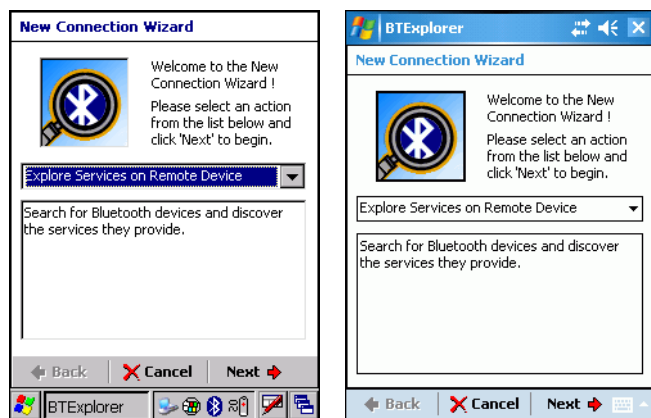

Figure 3-4 *New Connection Wizard Window*

3. Select an action from the drop-down list. In this example, **Explore Services on Remote Device** is selected.
4. Tap **Next**. The **BTEplorer** searches for Bluetooth devices in the area and displays the devices in the **Select Remote Device** window.

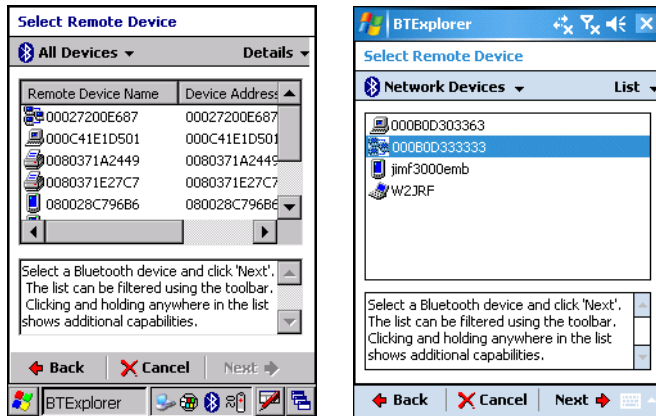

Figure 3-5 Select Remote Device Window

✓ **NOTE** Devices discovered previously are listed to save time. To start a new device discovery, tap and hold and select **Discover Devices** from the menu.

5. Select a device from the list and then tap **Next**. The **Connection Favorite Options** window appears.

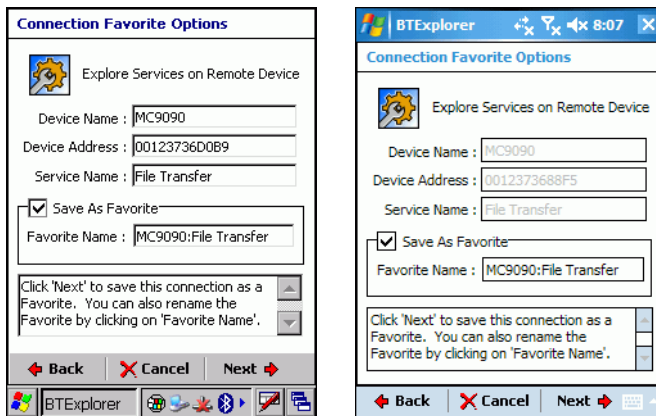

Figure 3-6 Connection Favorite Options Window

6. Select **Save As Favorite** check box to save this service in the **Favorite** view.
7. In the **Favorite Name** text box, enter a name for this service that will appear in the **Favorite** list.
8. Tap **Next**. The **Connection Summary** window appears.

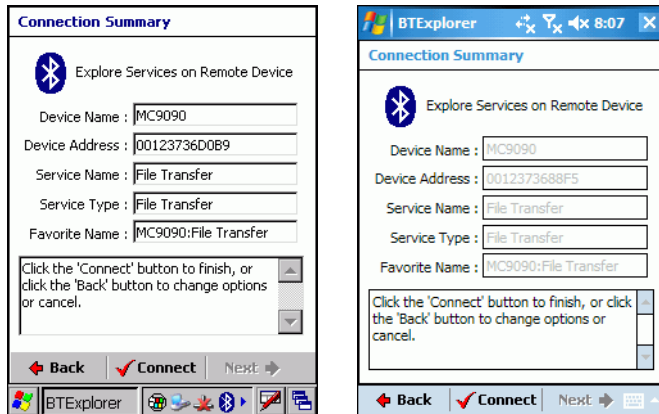

Figure 3-7 Connection Summary Window

9. Tap **Connect** to connect to the service.

The following actions are available in the drop-down list (actions may vary depending upon configurations):

- Explore Services on Remote Device
- Pair with a Remote Device
- Active Sync via Bluetooth
- Browse Files on Remote Device
- Connect to Internet Using Access Point
- Connect to Internet Using Phone/Modem
- Connect to a Personal Area Network
- Send or Exchange Objects
- Associate Serial Port.

Explorer Mode

The **BTExplorer** window is streamlined and easy to navigate and provides greater control to users familiar with Bluetooth functionality. The menu bar provides quick access to the options and tools used to connect to devices.

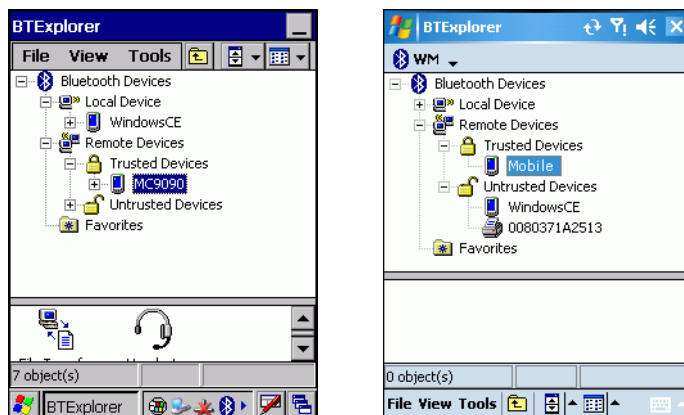

Figure 3-8 Explorer Mode Window

You can also use the “tap and hold” technique to view available options. Scroll bars and view options are like those you’re familiar with on your Windows desktop. The tree structure lists the following sub-items:

- Local Device - This MC909X mobile computer
- Remote Device - Other Bluetooth devices
 - Trusted Devices - Bonded (paired) Bluetooth devices
 - Untrusted Devices - Discovered devices that are not bonded
- Favorites - Selected services that are set as being *Favorite* for quick access.

✓ **NOTE** Switching between Wizard Mode and Explorer Mode closes all active connections.

Discovering Bluetooth Device(s)

Follow the steps below to discover Bluetooth devices. The mobile computer can receive information from discovered devices, without bonding. However, once bonded, an exchange of information between the mobile computer and a bonded device occurs automatically when the Bluetooth radio is turned on.

To find Bluetooth devices in the area:

1. Ensure that the Bluetooth device being looked for is in discoverable mode.
2. Ensure that the two devices are within 30 feet (10 meters) of one another.
3. Tap the **Bluetooth** icon and select **Show BTE Explorer**. The **BTE Explorer** window appears.

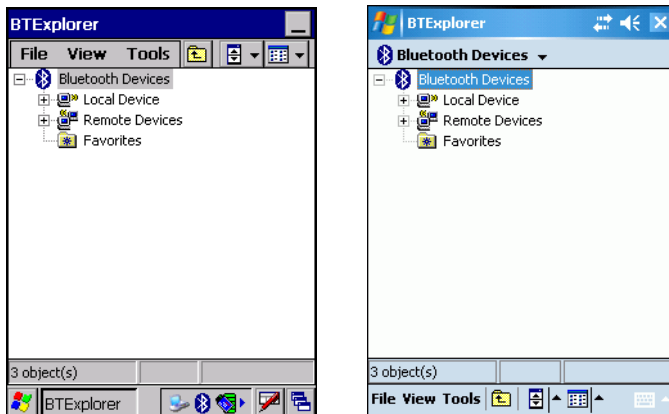

Figure 3-9 BTE Explorer Window

4. Tap and hold **Remote Devices** and select **Discover Devices** from the pop-up menu. The mobile computer searches for Bluetooth devices in the area.

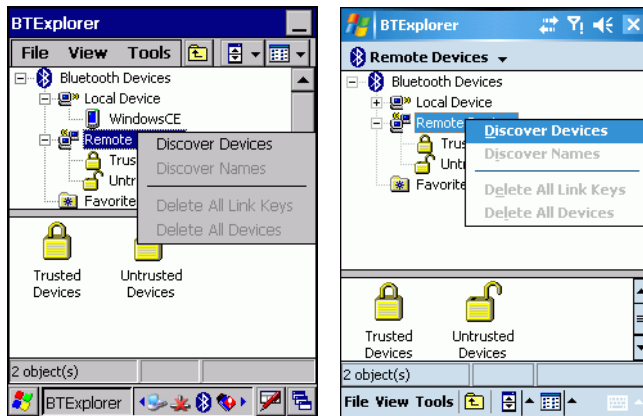

Figure 3-10 Discover Devices

5. The discovered devices display in the **Untrusted Devices** folder.

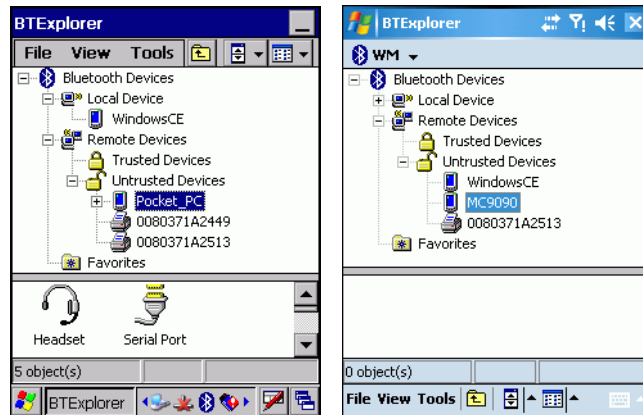

Figure 3-11 Discovered Devices Listed in Untrusted Folder

Bonding with Discovered Device(s)

A bond is a relationship created between the mobile computer and another Bluetooth device in order to exchange information in a secure manner. Creating a bond involves entering the same PIN on the two devices to bond. Once a bond is created, and the Bluetooth radios are turned on, the devices recognize the bond and are able to exchange information without re-entering a PIN.

To bond with a discovered Bluetooth device:

1. Discover remote devices. See [Discovering Bluetooth Device\(s\) on page 3-8](#).
2. In the **Untrusted Devices** folder, tap and hold on a device to pair with.

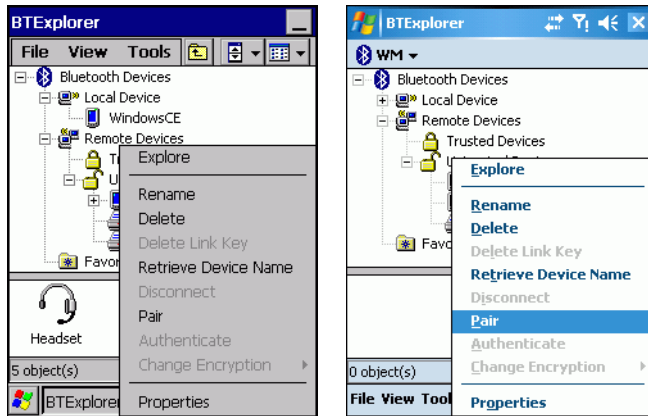

Figure 3-12 Pair a Remote Device

3. Select **Pair** from the pop-up menu.
4. On the mobile computer, the **PIN Code Request** window appears.

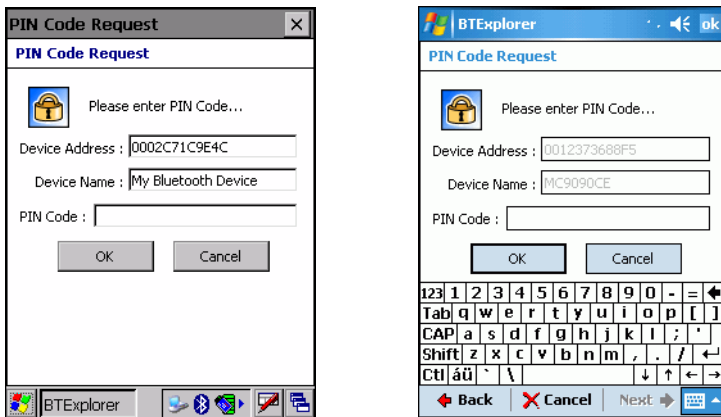

Figure 3-13 PIN Code Request Window

5. In the **PIN Code:** text box, enter the PIN number (between 1 and 16 characters) and then tap **OK**.
6. On the remote device, enter the same PIN number.
7. The devices are successfully paired. The device name moves to the **Trusted Devices** folder.

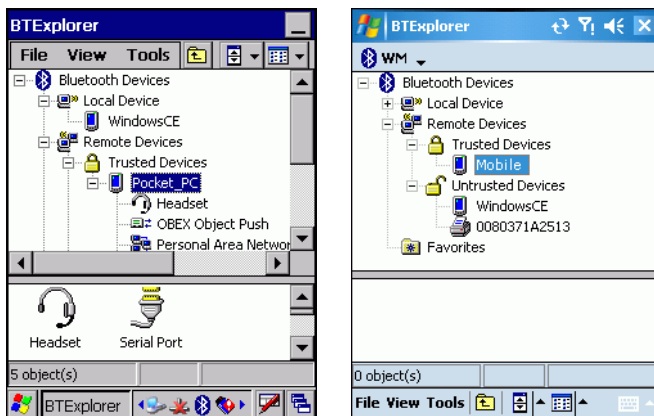

Figure 3-14 Bonded (Paired) Discovered Device

Renaming a Bonded Device

If it is necessary to rename a bonded device, it can be done from the **BTE Explorer** window.

1. Launch **BTE Explorer**.
2. Tap and hold the device to rename and select **Rename** in the pop-up menu.

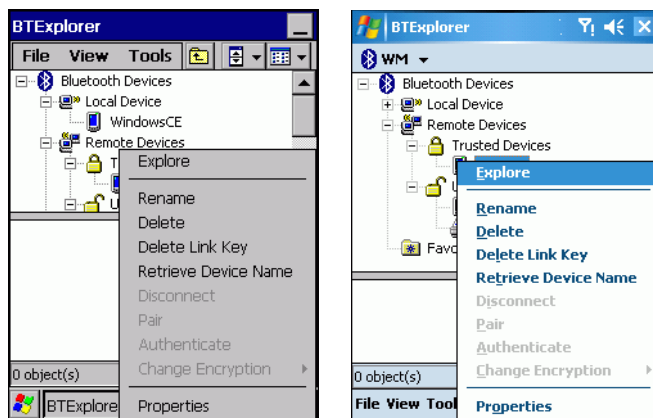

Figure 3-15 *Rename Device Selection Dialog Box*

3. The **Change Device Name** window appears.

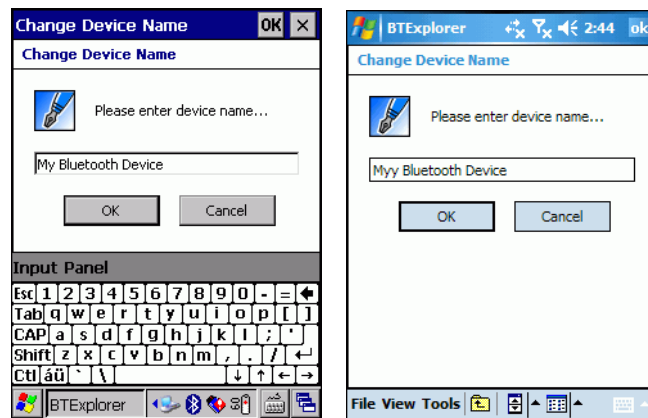

Figure 3-16 *Change Device Name Window*

4. Enter a new name for the bonded device in the text box. Tap **OK**.

Deleting a Bonded Device

If it is no longer necessary to connect with a device, delete it from the **Bluetooth Bonded Devices** window.

1. Launch **BTE Explorer**.
2. Tap and hold the device to delete and select **Delete** in the pop-up menu.

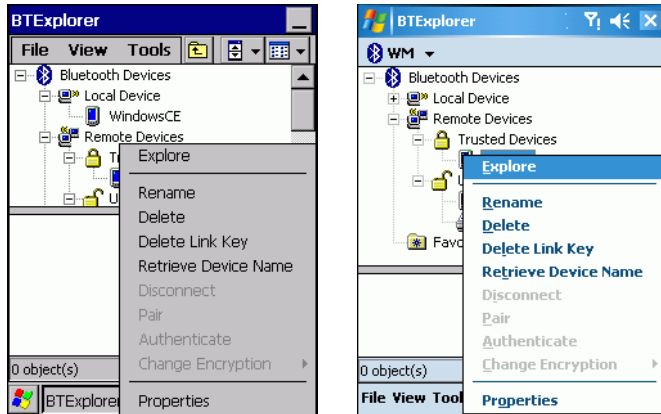

Figure 3-17 Delete a Bonded Device

3. A confirmation dialog appears. Tap **Yes**.

Accepting a Bond

When a remote device wants to bond with a mobile computer you give permission by entering a PIN when requested.

1. Ensure that the mobile computer is set to discoverable and connectable. See [Bluetooth Settings on page 3-22](#).
2. When prompted to bond with the remote device the **PIN Code Request** window appears.

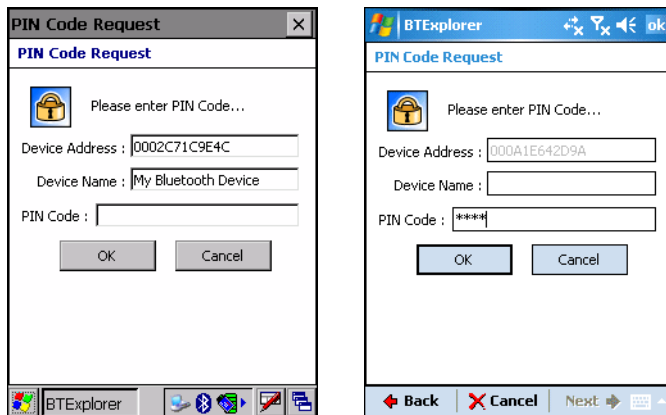

Figure 3-18 PIN Code Request Window

✓ **NOTE** Connections to untrusted devices are a security risk.

3. In the **PIN Code:** text box, enter the same PIN that was entered on the device requesting the bond. The PIN must be between 1 and 16 characters.
4. In the **Device Name:** text box, edit the name of the device requesting the bond, if desired.
5. Tap **OK**.
6. The bond is created and the mobile computer can now exchange information with the other device.

Discovering Services

Before services can be used, you must first discover remote devices and then bond to those devices.

To determine what services are available on a bonded remote device:

1. Tap the **Bluetooth** icon and select **Show BTE Explorer**.
2. In **BTE Explorer** window, tap and hold on the remote device and select **Explore** from the pop-up menu.

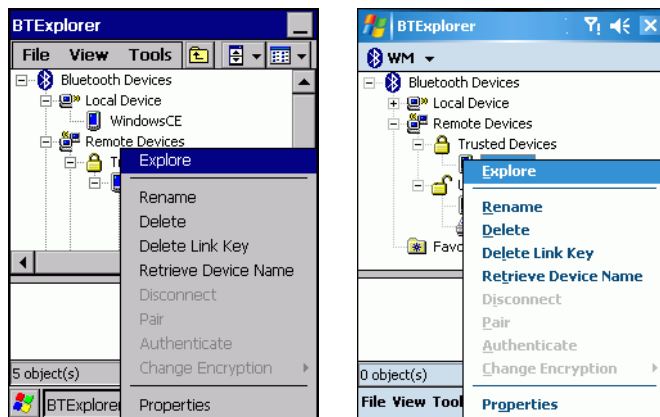

Figure 3-19 *Discovering Services*

3. The mobile computer communicates with the remote device and then lists the services under the device name.

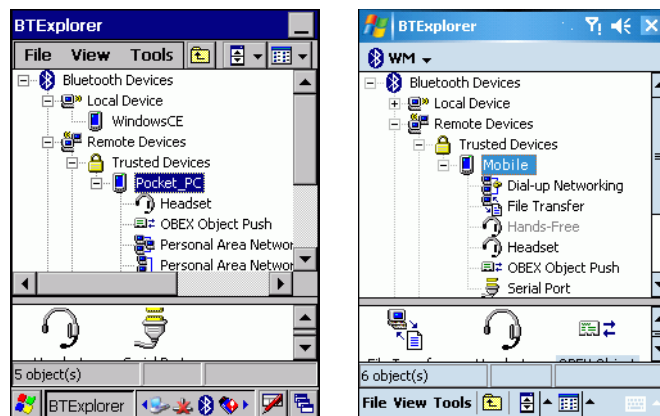

Figure 3-20 *List of Discovered Services*

Some examples of available services are:

- File Transfer Services
- Dial-Up Networking Services
- Headset or Hands-Free Services
- OBEX Object Push Services
- Serial Port Services
- IrMA Synchronization Services.

These services are discussed in the following paragraphs.

File Transfer Services

✓ **NOTE** Shared folders are a security risk.

To transfer files between the mobile computer and another Bluetooth enabled device:

1. Ensure the mobile computer is discoverable and connectable. See [Bluetooth Settings on page 3-22](#).
2. Discover and bond (pair) with the remote access point. See [Bonding with Discovered Device\(s\) on page 3-9](#).
3. In **BTE Explorer**, select the **Remote Devices** folder.
4. Select the **Trusted Devices** folder.
5. Tap the remote device folder.
6. Tap and hold on the remote device and select **Explore** from the pop-up menu.
7. Tap and hold on **File Transfer** and select **Connect**. The remote device's accessible folders appear.
8. Select a folder. The contents of the folder appear in the sub-window.

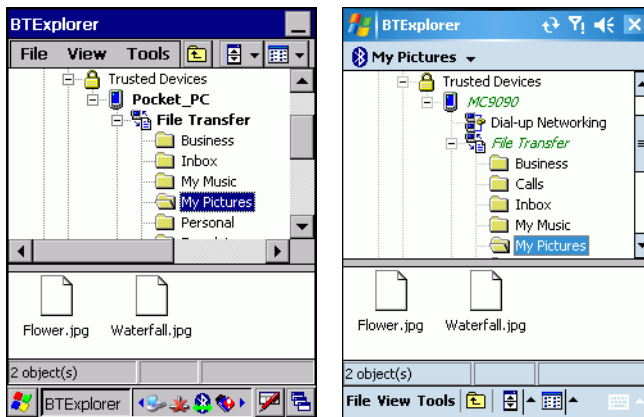

Figure 3-21 Remote Device Folders

9. Tap and hold on the file. A pop-up menu appears.
10. Select the action to perform:
 - a. *New* - create a new file or folder. on the remote device
 - b. *Delete* - delete the selected file on the remote device.
 - c. *Get File* - copy the file from the remote device to the mobile computer.
 - d. *Put File* - copies a file from the mobile computer to the remote device.

Create New File or Folder

To create a new folder or file on the remote device:

1. Tap and hold on the file and select **New > Folder** or **New > File**. The **Create New Folder** or **Create New File** window appears.
2. Enter the name for the new folder or file. Tap **OK**.
3. A new folder or file is created on the remote device.

Delete File

To delete a file from the remote device:

1. Tap and hold on the file and select **Delete**.
2. In the **Delete Remote Device File** dialog box tap **OK**.

Get File

To copy a file from a remote device:

1. Tap and hold on the file and select **Get**. The **Save Remote File** window appears.
2. Navigate to the directory to save the file.
3. Tap **Save**. The file is transferred from the remote device to the mobile computer.

Put File

To copy a file to a remote device:

1. Tap and hold on the file and select **Put**. The **Send Local File** window appears.
2. Navigate to the directory to save the file and select a file.
3. Tap **Open**. The file is transferred from the mobile computer to the remote device.

Connect to Internet Using Access Point

This section explains how to access a Bluetooth-enabled LAN access point (AP) for a network connection. With this method of communication the Internet Explorer can be used to connect to a server.

1. Ensure the mobile computer is discoverable and connectable. See [Bluetooth Settings on page 3-22](#).
2. Discover and bond (pair) with the remote access point. See [Bonding with Discovered Device\(s\) on page 3-9](#).
3. In **BTEplorer**, select the **Remote Devices** folder.
4. Select the **Trusted Devices** folder.
5. Tap the remote device folder.
6. Tap and hold on the remote device and select **Explore** from the pop-up menu.
7. Tap and hold **LAN Access using PPP** service and select **Connect** from the pop-up menu.
8. The mobile computer connects with the Access Point.
9. Tap **Start > Internet Explorer**. The **Internet Explorer window** appears.
10. In the address field, enter an internet address and tap the **Enter** button. The web page loads.

Dial-Up Networking Services

To use a phone that has Bluetooth capabilities as a modem for the mobile computer, create a Bluetooth modem connection on the mobile computer and send information to the phone using Bluetooth. The phone relays the information over the phone line and sends back to the mobile computer any information that was requested over the connection. Once a modem connection is created to the Bluetooth phone, it can be reused.

Prior to creating a connection, ensure the following:

- Bluetooth phone is turned on.
- Bluetooth phone is discoverable. (Some phones may also need to be pairable in order to accept a bonding request. For more information, refer to the phone documentation.)
- Mobile computer's and phone's Bluetooth radios are turned on.
- Mobile computer and phone are within range of each other (30 feet/10 meters).

Complete the following steps to create a new Bluetooth connection. Before setting up dial-up networking, obtain dial-up information and other necessary settings for the office network or ISP.

1. Ensure the mobile computer is discoverable and connectable. See [Bluetooth Settings on page 3-22](#).
2. Discover and bond (pair) with the remote device. See [Bonding with Discovered Device\(s\) on page 3-9](#).
3. In **BTExplorer**, select the **Remote Devices** folder.
4. Select the **Trusted Devices** folder.
5. Tap the remote device folder.
6. Tap and hold on **Dial-up Networking** and select **Connect** from the pop-up menu. The **Select Dial-up Networking Entry** window appears.

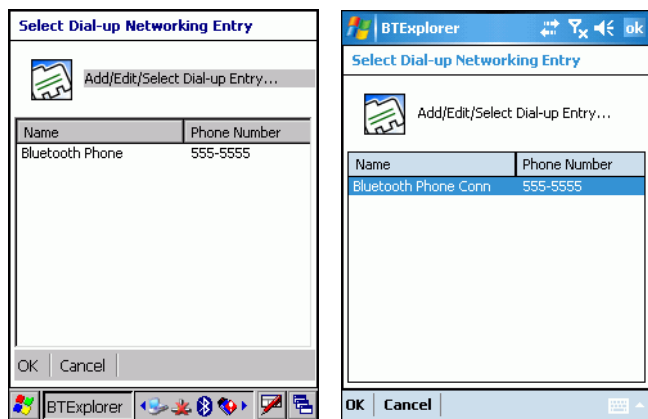

Figure 3-22 Select Dial-up Networking Entry Window

✓ **NOTE** If a dial-up entry is not listed, see [Add a Dial-up Entry on page 3-17](#).

7. Select a dial-up entry.
8. Tap **OK**. The mobile computer begins to communicate with the phone. If required, the phone requests permission to communicate with the mobile computer.
9. Confirm the connection on the phone. The **Network Log On** window appears.



Figure 3-23 Network Log On Window

10. In the **User name:** text box, enter the user name for this connection.
11. In the **Password:** text box, enter the password for this connection.
12. In the **Domain:** text box, enter the domain for this connection, if required.
13. Tap **OK**.
14. The phone begins dialing.
15. The phone connects to the network.
16. To end a session, tap the **Connection** icon and then tap **Disconnect** in the dialog box.

Add a Dial-up Entry

To add a dial-up entry:

1. In the **Select Dial-up Networking Entry** window, tap and hold and then select **Add Entry** from the pop-up menu.

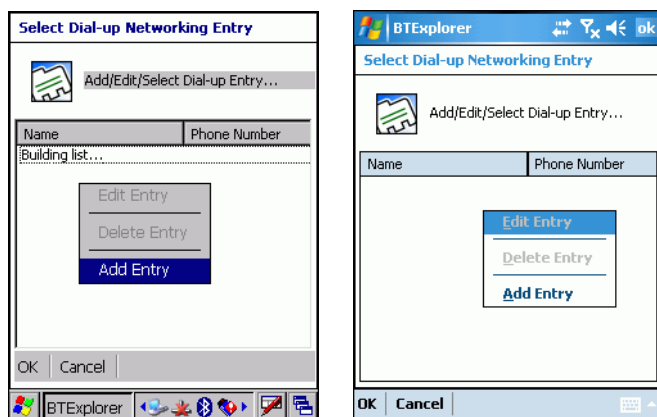

Figure 3-24 Add Dial-Up Entry

2. The **Add Phone Book Entry** window appears.

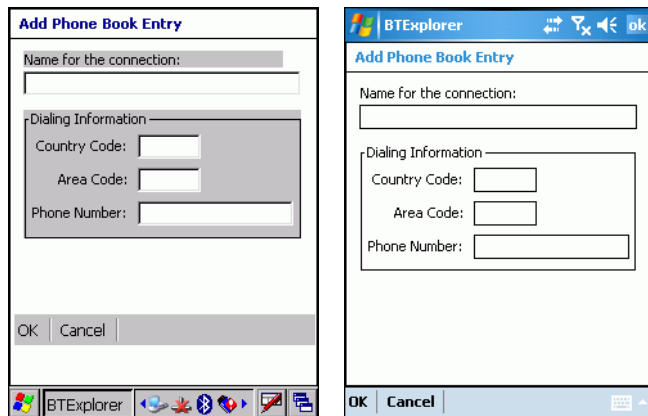

Figure 3-25 Add Phone Book Entry

3. In the **Name for the connection** text box, enter a name for this connection.
4. In the **Country Code** text box, enter the country code for the country that you are calling.
5. In the **Area Code** text box, enter the area code.
6. In the **Phone Number** text box, enter the phone number.
7. Tap **OK**.

OBEX Object Push Services

Object Exchange (OBEX) is a set of protocols allowing objects such as Contacts or pictures to be shared using Bluetooth.

To exchange contact information with another Bluetooth enabled device:

1. Ensure the mobile computer is discoverable and connectable. See [Bluetooth Settings on page 3-22](#).
2. Discover and bond (pair) with the remote device. See [Bonding with Discovered Device\(s\) on page 3-9](#).
3. In **BTExplorer**, select the **Remote Devices** folder.
4. Select the **Trusted Devices** folder.
5. Tap the remote device folder.
6. Tap and hold on **OBEX Object Push** and select **Connect**. The **OBEX Object Push** window appears.
7. In the **Action** drop-down list, select one of the options: **Send Contact Information**, **Swap Contact Information**, **Fetch Contact Information** or **Send a Picture**.

Send a Picture

To send a picture to another device:

1. Ensure the mobile computer is discoverable and connectable. See [Bluetooth Settings on page 3-22](#).
2. Discover and bond (pair) with the remote device. See [Bonding with Discovered Device\(s\) on page 3-9](#).
3. In **BTExplorer**, select the **Remote Devices** folder.
4. Select the **Trusted Devices** folder.

5. Tap the remote device folder.
6. Tap and hold on **OBEX Object Push** and select **Connect**. The **OBEX Object Push** window appears.

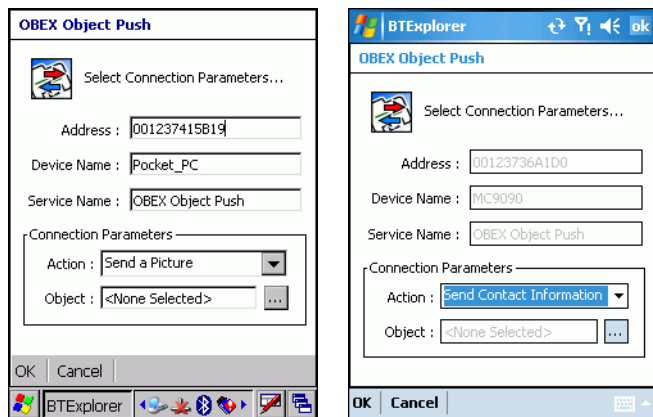



Figure 3-26 OBEX Object Push Window

7. In the **Action** drop-down list, select **Send A Picture**.
8. Tap . The **Send Local Picture** window appears.

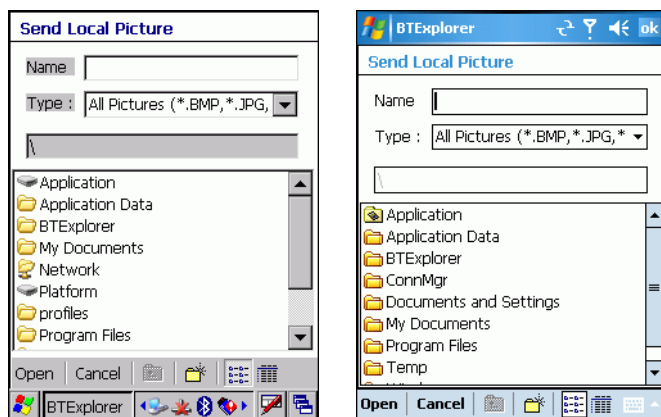

Figure 3-27 Send Local Picture Window

9. Navigate to the picture that you want to send to the other device.
10. Tap **Open**.
11. Tap **OK**. The picture is sent to the other device and a confirmation dialog box appears on the other device to accept the picture. A **Send Picture** dialog appears.
12. Tap **Ok**.

Headset Services

✓ **NOTE** Not available on MC9090-G with Windows CE 5.0.

To connect to a Bluetooth headset:

1. Ensure the mobile computer is discoverable and connectable. See [Bluetooth Settings on page 3-22](#).

2. Discover and bond (pair) with the headset.
3. In **BTE Explorer**, select the **Remote Devices** folder.
4. Select the **Trusted Devices** folder.
5. Tap the remote device folder.
6. Tap and hold on the remote device and select **Explore**. A headset service item appears.
7. Tap and hold on the headset service name and select **Connect**.
8. The mobile computer connects to the headset. Refer to your headset user manual for instruction on communicating with a Bluetooth device.
9. To answer a phone call, press the Green Dot button on the mobile computer and press the Red Dot button to end a call.

✓ **NOTE** If the mobile computer goes into suspend mode while in a call, the Bluetooth headset disconnects from the mobile computer and audio is re-directed to the speakerphone.

To adjust the microphone gain:

1. Tap and hold on the headset service item and select **Adjust Microphone** from the pop-up menu. The **Microphone Properties** window appears.
2. Select the slider and adjust the gain.
3. Tap **OK**.

Serial Port Services

✓ **NOTE** By default, COM ports COM4, COM5 and COM9 are Bluetooth virtual ports. If an application opens one of these ports, the Bluetooth driver activates and guides you through a Bluetooth connection.

Use the wireless Bluetooth serial port connection just as you would a physical serial cable connection. You must configure the application that will use the connection to the correct serial port.

To establish a serial port connection:

1. Ensure the mobile computer is discoverable and connectable. See [Bluetooth Settings on page 3-22](#).
2. Discover and bond (pair) with the remote device. See [Bonding with Discovered Device\(s\) on page 3-9](#).
3. In **BTE Explorer**, select the **Remote Devices** folder.
4. Select the **Trusted Devices** folder.
5. Tap the remote device folder.
6. Tap and hold **Serial Port** and select **Connect** in the pop-up menu. The **Remote Service Connection** window appears.

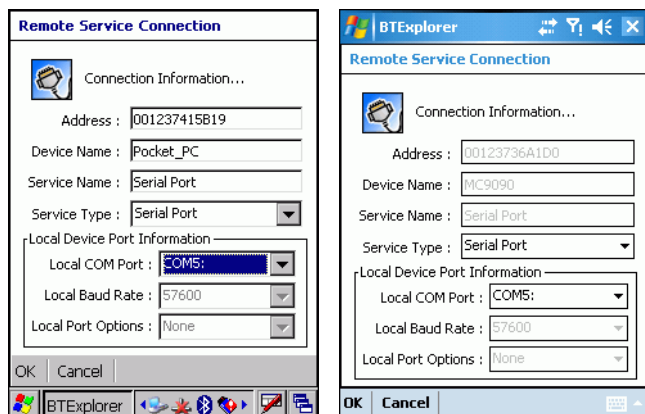

Figure 3-28 Remote Service Connection Window

7. In the **Local COM Port** drop-down list select a COM port.
8. Tap **OK**.

Personal Area Network Services

Connect two or more Bluetooth devices to share files, collaborate or play multi player games.

To establish a Personal Area Network connection:

1. Ensure the mobile computer is discoverable and connectable. See [Bluetooth Settings on page 3-22](#).
2. Discover and bond (pair) with the remote device. See [Bonding with Discovered Device\(s\) on page 3-9](#).
3. In **BTEplorer**, select the **Remote Devices** folder.
4. Select the **Trusted Devices** folder.
5. Tap the remote device folder.
6. Tap and hold **Personal Area Network** and select **Connect** in the pop-up menu.

IrMC Synchronization Services

✓ **NOTE** This service is only available WWAN configurations with OEM version 01.39.0001 and higher.

IrMC Synchronization is used to synchronize PIM contacts between a remote device and the mobile computer. To establish an IrMC synchronization:

1. Ensure the EDA is discoverable and connectable. See [Bluetooth Settings on page 3-22](#).
2. Discover and bond (pair) with the remote device. See [Bonding with Discovered Device\(s\) on page 3-9](#).
3. In **BTEplorer**, select the **Remote Devices** folder.
4. Select the **Trusted Devices** folder.
5. Tap the remote device folder.
6. Tap and hold **IrMA Synchronization** and select **Connect** in the pop-up menu.

Bluetooth Settings

Use the **BTE Explorer Settings** window to configure the operation of the **BTE Explorer** application. Tap **Tools > Settings**. The **BTE Explorer Settings** window appears.

Device Info Tab

Use the **Device Info** tab to configure the mobile computer's Bluetooth connection modes.

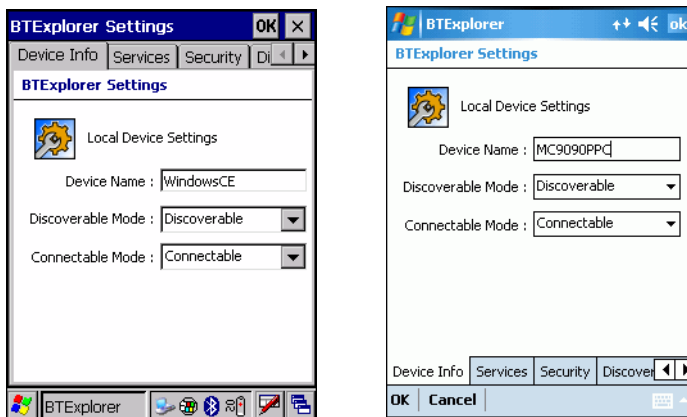

Figure 3-29 BTE Explorer Settings - Device Info Tab

Device Name	Displays the name of the mobile computer.
Discoverable Mode	Allows you to set the mobile computer to be discoverable by other Bluetooth devices or not be discoverable. Note: For security reasons, the default is set to Non Discoverable .
Connectable Mode	Allows you to set the mobile computer to be connectable by other Bluetooth devices or not be connectable. Note: For security reasons, the default is set to Non Connectable .

Services Tab

✓ **NOTE** For security reason, by default services are not enabled.

Use the **Services** tab to add or delete Bluetooth services.

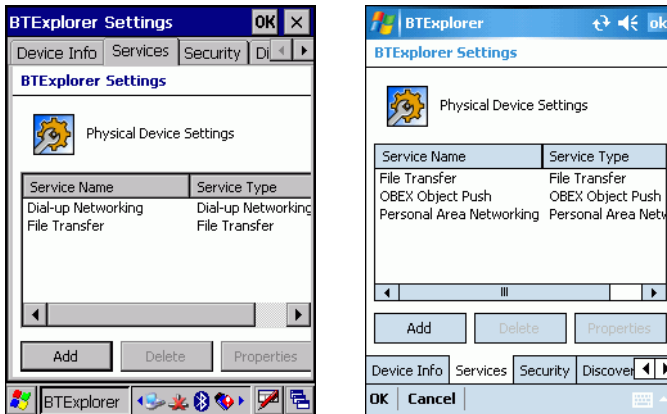

Figure 3-30 BTE Explorer Settings - Services Tab

To add a service:

1. Tap **Add**. The **Add Local Service** window displays.

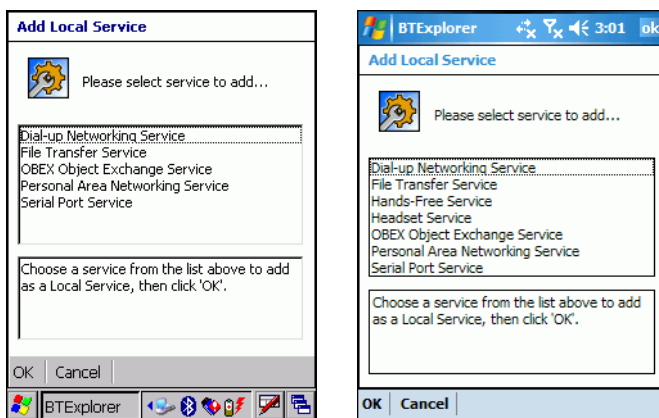

Figure 3-31 Add Local Service Window

2. In the list, select a service to add.
3. Tap **OK**. The **Edit Local Service** window displays for the selected service.
4. Select the appropriate information and then tap **OK**. See the following paragraphs for detailed information on the available services.

Dial-Up Networking Service

Dial-up Networking allows a dial-up modem to be accessed by other Bluetooth devices.

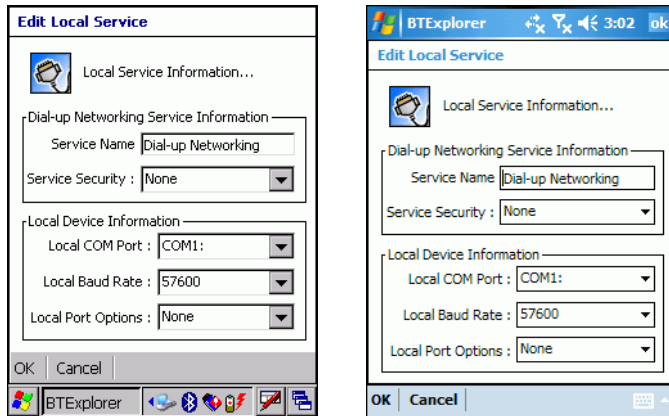

Figure 3-32 Add Local Service Window

- Service Name Displays the name of the service.
- Service Security Select the type of security from the drop-down list; None, Authenticate or Authenticate/Encrypt.
- Local COM Port Select the COM port. Select COM1 to use a modem or other device that is connected to the connector on the bottom of the mobile computer.
- Local Baud Rate Select the communication baud rate.
- Local Port Options Select the port option.

File Transfer Service

File transfer allows files to be browsed by other Bluetooth devices.

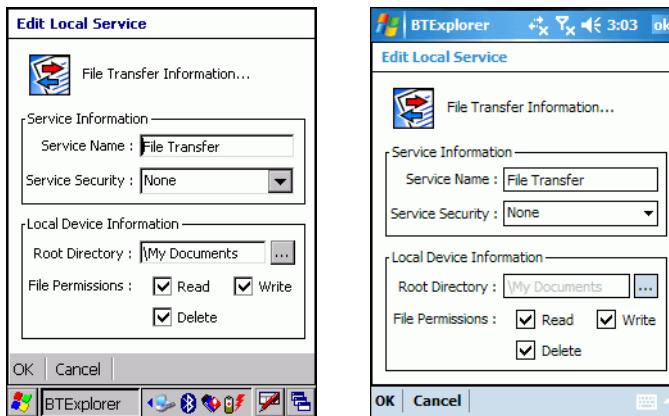

Figure 3-33 File Transfer Information Window

- Service Name Displays the name of the service.
- Service Security Select the type of security from the drop-down list; None, Authenticate or Authenticate/Encrypt.

Root Directory	Select the directory that other Bluetooth devices can access.
File Permissions	Select the file permissions for the selected directory. Check the appropriate box to grant Read access, write access and delete access.

OBEX Object Push Service

OBEX Object Push allows contacts, business cards, pictures, appointments, and tasks to be pushed to the device by other Bluetooth devices.

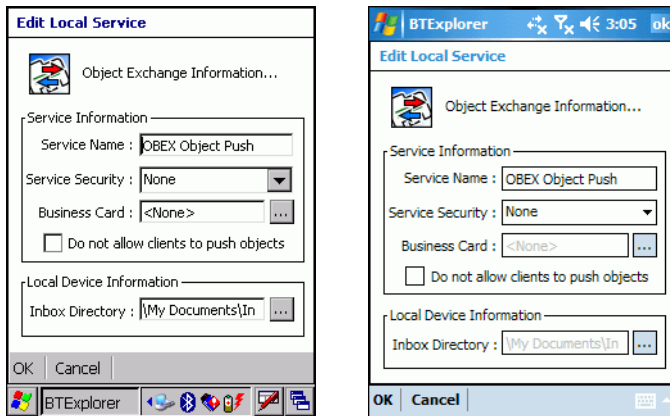

Figure 3-34 OBEX Exchange Information Window

Service Name	Displays the name of the service.
Service Security	Select the type of security from the drop-down list; None , Authenticate or Authenticate/Encrypt .
Business Card	Select a contact information to another mobile device.
Do not allow clients to push objects	Disables clients from pushing objects to the mobile computer.
Inbox Directory	Select a directory where another Bluetooth device can store files.

Personal Area Networking Service

Personal Area Networking hosts a Personal Area Network which allows communication with other Bluetooth devices.

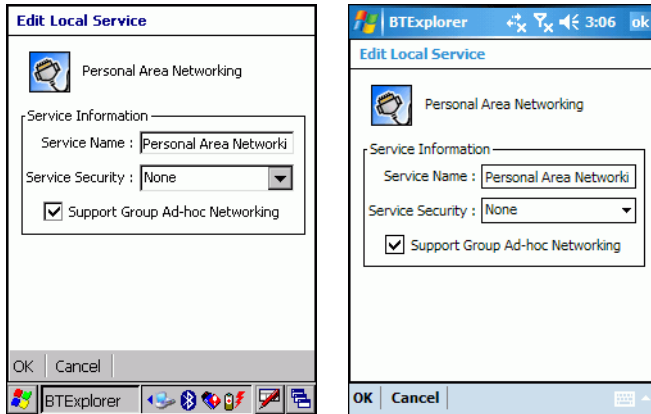

Figure 3-35 Personal Area Networking Window

- Service Name Displays the name of the service.
- Service Security Select the type of security from the drop-down list; **None**, **Authenticate** or **Authenticate/Encrypt**.
- Support Group Ad-Hoc Networking Select to enable Ad-Hoc networking.

Serial Port Service

Serial port allows COM ports to be accessed by other Bluetooth devices.

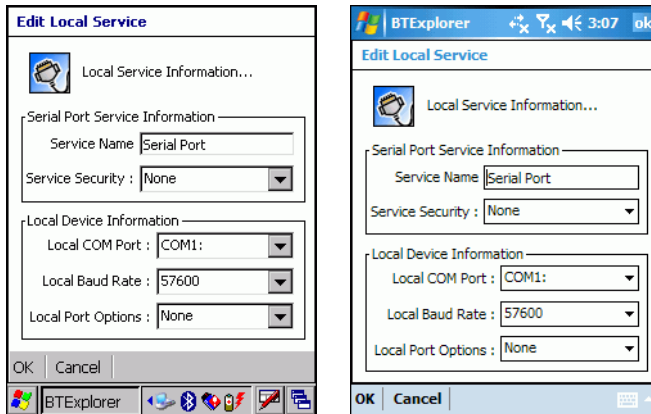

Figure 3-36 Serial Port Service Window

- Service Name Displays the name of the service.
- Service Security Select the type of security from the drop-down list; **None**, **Authenticate** or **Authenticate/Encrypt**.
- Local COM Port Select the COM port. Select COM1 to use a modem or other device that is connected to the connector on the bottom of the mobile computer.
- Local Baud Rate Select the communication baud rate.
- Local Port Options Select the port option.

Headset Service

✓ **NOTE** Not available on MC9090-G with Windows CE 5.0.

Serial port allows COM ports to be accessed by other Bluetooth devices.

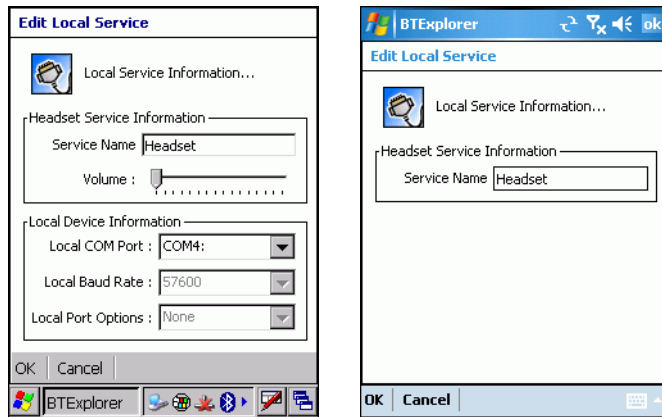

Figure 3-37 Headset Service Window

Service Name Displays the name of the service.

IrMC Synchronization Service

✓ **NOTE** This service is only available on WWAN configurations with OEM version 01.39.0001 and higher.

The IrMC Synchronization service used to synchronize PIM contacts between a remote device and the EDA.

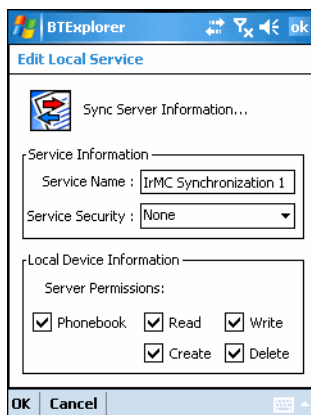

Figure 3-38 IrMC Synchronization Service Window

Service Name	Displays the name of the service.
Service Security	Select the type of security from the drop-down list. Options are None , Authenticate , or Authenticate/Encrypt .
Phonebook	Select the Phonebook checkbox to allow synchronization with the EDA's contacts. Select Read , Write , Create and/or Delete to allow phonebook permissions.

Security Tab

To adjust the security settings for an individual service, select the **Services** tab first, then select the individual service, then **Properties**.

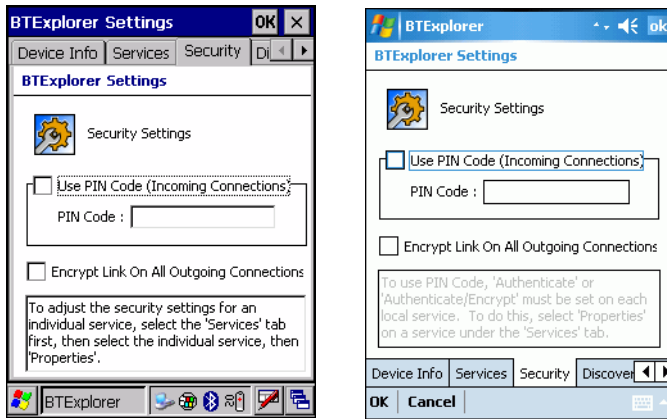

Figure 3-39 BTE Explorer Settings - Security Tab

Use PIN Code (Incoming Connecting)	Select for automatic use of the PIN code entered in the PIN Code text box. It is recommended not to use this automatic PIN code feature. See Security on page 3-2 for more information.
PIN Code	Enter the PIN code.
Encrypt Link On All Outgoing Connections	Select to enable or disable encryption. Use encryption whenever possible.

Discovery Tab

Use the **Discovery** tab to set and modify discovered devices.

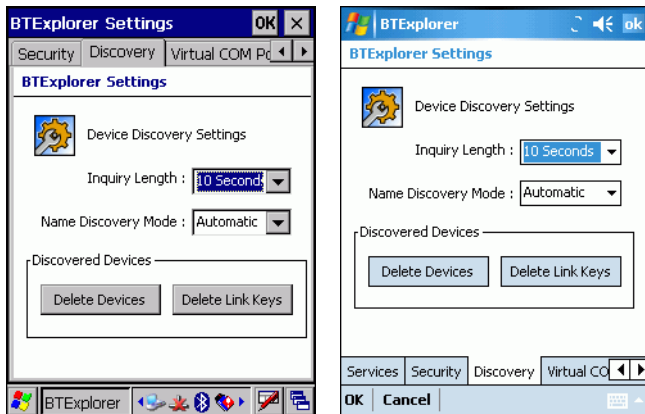

Figure 3-40 BTE Explorer Settings - Discovery Tab

Inquiry Length	Sets the amount of time that the mobile computer takes to discover Bluetooth devices in the area.
Name Discovery Mode	Select either Automatic or manual .
Discovered Devices	Deletes all discovered devices and link keys.

Virtual COM Port Tab

Use the **Virtual COM Port** tab to select the COM ports for Bluetooth communication.

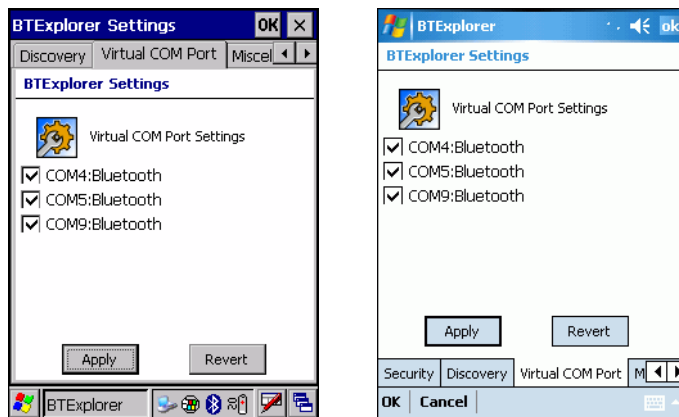

Figure 3-41 BTE Explorer Settings - Virtual COM Port Tab

COM4:Bluetooth	Enable or disable COM Port 4.
COM5:Bluetooth	Enable or disable COM Port 5
COM9:Bluetooth	Enable or disable COM Port 9

✓ **NOTE** If an application uses one of the COM ports assigned to Bluetooth, opening this port causes the Bluetooth stack to activate and guide you through the connection process.



Figure 3-42 COM Port Connection

Miscellaneous Tab

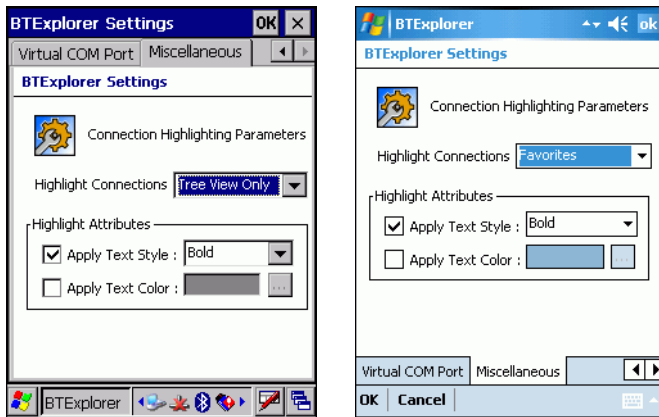

Figure 3-43 BTExplorer Settings - Miscellaneous Tab

Highlight Connections

Select the connection type to highlight when connected. In the Wizard Mode, the only option is **Favorites** or **None**. In the **Explorer Mode** the options are **None**, **Tree View Only**, **List View Only** or **Tree and List View**.

Apply Text Style

Select the text style to be applied to the connection text.

Apply Text Color

Select the text color to be applied to the connection text.

Chapter 4 Using MC9094 Phone

Introduction

Use the MC9094 phone to make phone calls, set up speed dials, keep track of calls, and send text messages. Your wireless service provider may also provide other services such as voice mail, call forwarding, and caller ID.

Also use the integrated phone to connect to an ISP or work network in order to browse the Web and read e-mail. Connect to the Internet or work network over GPRS using Cellular Line, or using the modem specified by the mobile operator. For more information, or to customize the phone by changing phone settings, see the *MC909X Integrator Guide*.

Accessing the Phone Keypad

The keypad can be accessed regardless of the program in use on the mobile computer. Applications on the mobile computer can be in use during a call.

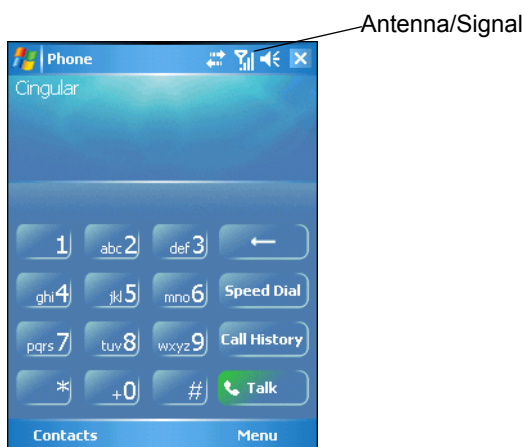

Figure 4-1 MC9094 Phone Keypads

✓ **NOTE** Keypads can vary depending on services and the state of the phone. For example, calls can be placed on hold and **Swap** can be used to switch active calls on hold. (See [Swapping Calls on page 4-15](#).)

To access the phone keypad tap **Start > Phone** or press the green dot key on the mobile computer's keypad.

To receive calls when the mobile computer is suspended, leave the phone radio turned on and ensure the mobile computer is set to wake with any key.

Making a Call Using the Keypad

Phone calls can be dialed from the phone keypad, using speed dial or from call history. The most direct method is by using the phone keypad. You can communicate on the phone using the mobile computer's speakerphone or a headset.

To make a call using the phone keypad:

1. Tap **Start > Phone** or press the green dot key on the mobile computer's keypad.
2. Using the Phone keypad or the mobile computer keypad, enter the phone number to call.
3. Tap **Talk**. The phone begins to dial.
4. Hold the mobile computer as shown. You can control the volume of the speaker using .



Figure 4-2 *Using the Phone in Speakerphone Mode*

5. Tap **End** to stop dialing or end the call.

✓ **NOTE** The green and red dot keys on the mobile computer keypad can also be used to dial (green) and end (red) calls.

Answering a Call

A dialog box appears on the mobile computer's display screen when you receive an incoming call. If the phone is set to ring, a ring tone sounds. You can answer the incoming call or ignore the call.

To answer an incoming call tap **Answer** or press the green dot key on the mobile computer keypad.

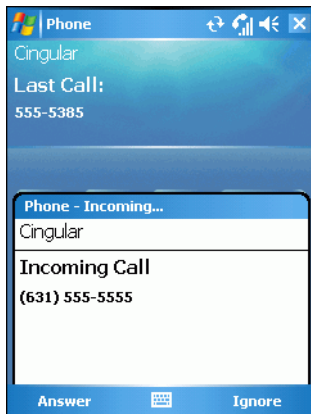

Figure 4-3 *Incoming Call*

To ignore the incoming the call tap **Ignore**. This may send the caller to voice mail, depending on the service provider.

To end the call tap **End** or press the red dot key on the mobile computer keypad.

Audio Modes

The mobile computer offers two audio modes to use during phone calls:

- **Speaker Mode:** Use the mobile computer as a speaker phone. This is the default mode, The **Speaker On** button is inactive.
- **Headset Mode:** Connect a headset to the headset jack to automatically switch audio to the headset.

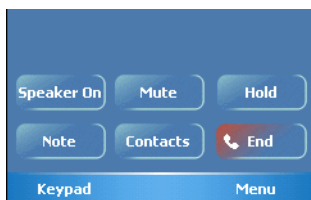

Figure 4-4 *Speaker Button*

Incoming Call Features

- If you receive a call while in a call, tap **Wait** to place the call in call waiting.
- You can use other programs on the mobile computer during a call. To switch back to Phone, tap **Talk** or tap **Start > Phone**. Tap **End** to end the call.
- If a caller isn't in your contact list, create a contact during the call or from Call History by tapping **Menu > Save to Contacts**.
- To terminate a call when a second call comes in and answer the waiting call, tap **End** on the Phone keypad to disconnect the active call, then tap **Answer** or press the **Send** key to answer the waiting call.
- To hold the current call and answer a waiting call, tap **Answer** or press the **Send** key to place the current call on hold and answer the incoming call.
- To put a call on hold to call another number or answer an incoming call, tap **Hold**. To move from one call to another, tap **Swap**.

Muting a Call

During a call, you can mute the microphone so that the person on the line can be heard but cannot hear conversation from the microphone. This is useful when there is conversation or background noise on the user's end.

To mute or unmute a call:

1. Tap **Start > Phone** or press the green phone key on the mobile computer's keypad.
2. Tap **Mute** on the phonepad. The **Mute** icon appears.

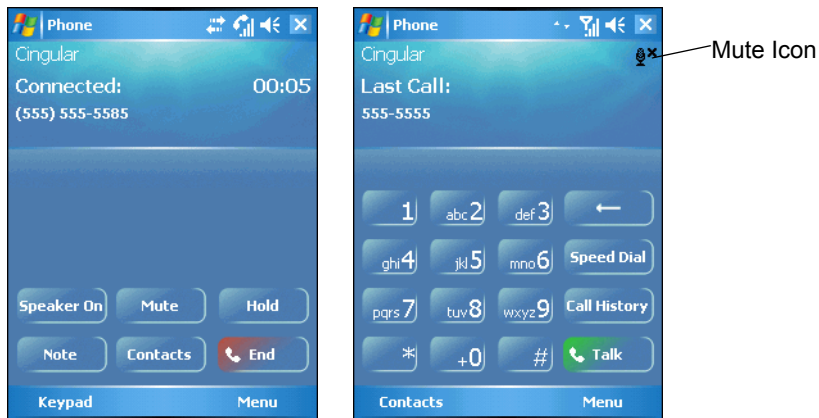

Figure 4-5 Mute Button and Icon

Taking Notes

To create a note during a call tap **Note** on the phonepad then enter the note. For more information about creating notes see the Windows On-Device Help.

To access a note created during a call:

1. Tap **Start > Phone** or press the green dot key on the mobile computer's keypad.
2. From the phonepad, tap **Call History**.
3. Tap and hold the number or the **Note** icon for the phone call entry containing the note.

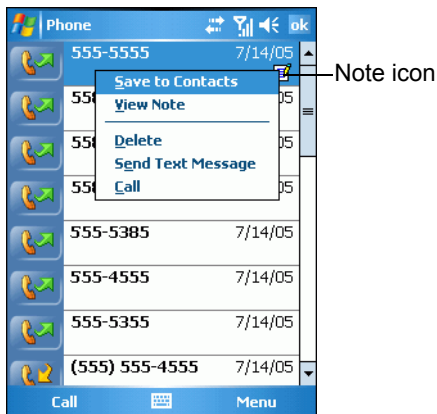

Figure 4-6 Call History - Notes Menu

4. Select View Note.

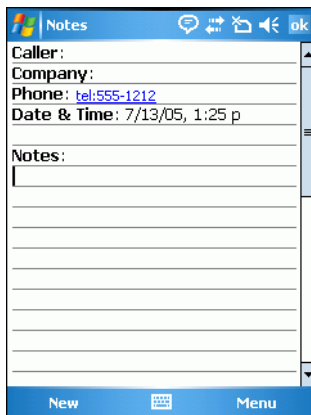

Figure 4-7 Call History - Notes

5. Tap ok to exit.

- ✓ **NOTE** Notes can also be accessed directly from the **Notes** application by tapping **Start > Notes**.

Using Speed Dial

Create speed dial numbers to dial frequently called numbers with a single tap. Before a speed dial entry can be created, the phone number must already exist in **Contacts**.

Adding a Speed Dial Entry

To add a speed dial entry from the phone keypad:

1. Ensure the contact and phone number are in the **Contacts** list.
2. Tap **Start > Phone** or press the green dot key on the mobile computer's keypad.
3. Tap **Speed Dial > Menu > New**.

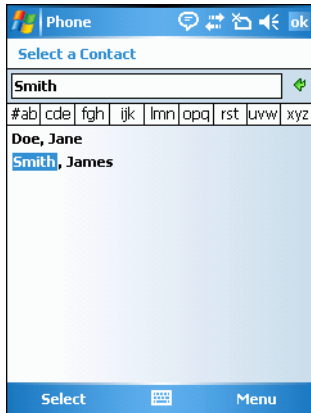

Figure 4-8 *Contacts*

4. Tap the desired contact name and number in the list.

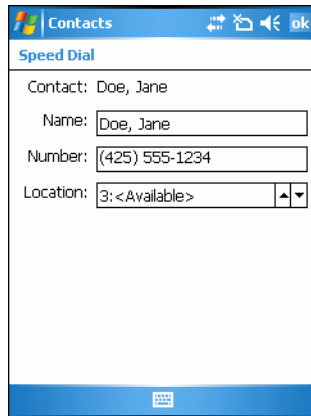

Figure 4-9 *Speed Dial Contact Location*

5. In the **Location** field, tap the Up/Down arrows to select an available location to assign as the new speed dial entry. The first speed dial location is reserved for voice mail.
6. Tap **ok** to add the contact to the speed dial list.

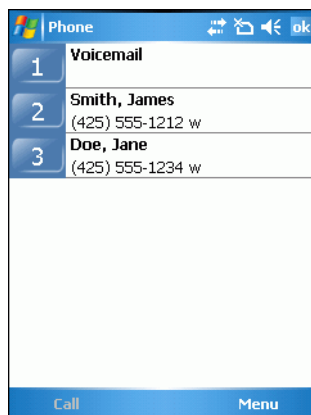

Figure 4-10 *Speed Dial Contact List*

7. Tap **ok** to exit the **Speed Dial Contact List**.

To add a speed dial entry from the **Contacts** window:

1. Tap **Start > Contacts**.

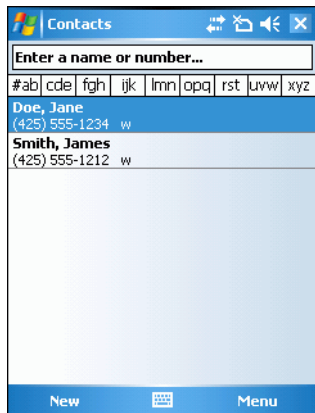

Figure 4-11 *Contacts*

2. Tap and hold the contact name.

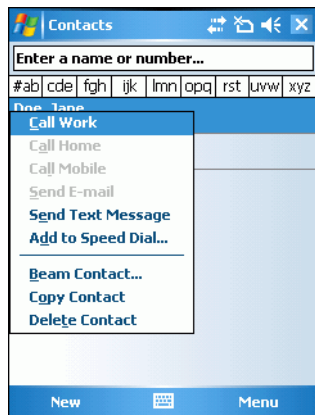

Figure 4-12 *Contacts Menu*

3. Tap **Add to Speed Dial**.

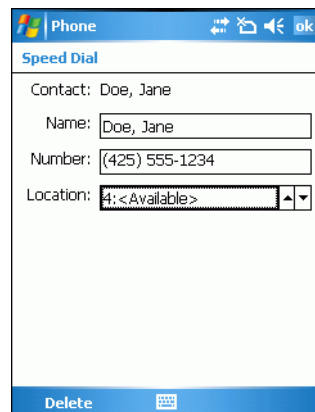

Figure 4-13 *Speed Dial Contact Location*

4. Tap the Up/Down arrows to select an available location to assign as the new speed dial entry. The first speed dial location is reserved for voice mail.
5. Tap **ok**.

Editing a Speed Dial Entry

1. Tap **Start > Phone** or press the green dot key on the mobile computer's keypad.
2. Tap **Speed Dial**.

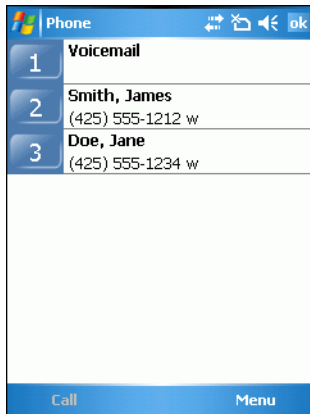

Figure 4-14 Speed Dial Contact List

3. Tap and hold the contact name.

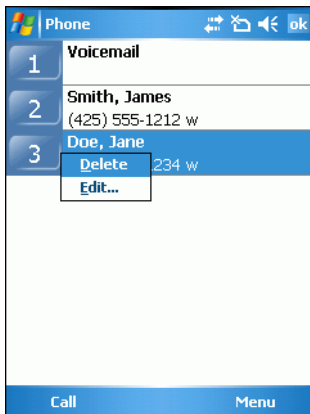

Figure 4-15 Speed Dial Delete Menu

4. Tap **Edit...**
5. Change the name, phone number or location information.
6. Tap **ok**.

✓ **NOTE** Editing names and phone numbers in **Speed Dial** does not alter contact information in **Contacts (Start > Contacts)**.

Deleting a Speed Dial Entry

1. Tap **Start > Phone** or press the green dot key on the mobile computer's keypad.

2. Tap **Speed Dial**.
3. Tap and hold the contact name.

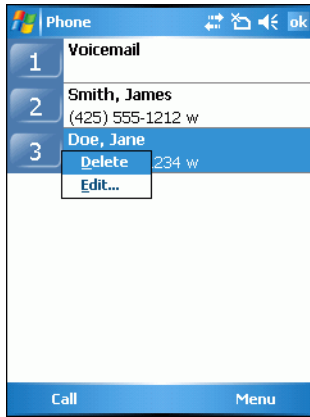

Figure 4-16 Speed Dial Delete Menu

4. Tap **Delete**.
5. Tap **Yes** to confirm permanently deleting the speed dial entry.

✓ **NOTE** Deleting names and phone numbers in **Speed Dial** does not delete the contact information in **Contacts** (**Start > Contacts**).

Making a Speed Dial Call

Use Speed Dial to call someone saved in the speed dial directory.

To make a speed dial call:

1. Tap **Start > Phone** or press the green dot key on the mobile computer's keypad.
2. Tap and hold the speed dial location number assigned to a contact. (To dial a one-digit speed dial location number, tap and hold the speed dial number. To dial a two-digit speed dial location number, tap the first digit and then tap and hold the second digit.)

or

From the keypad, tap **Speed Dial** and tap the speed dial location number of the desired contact in the list.

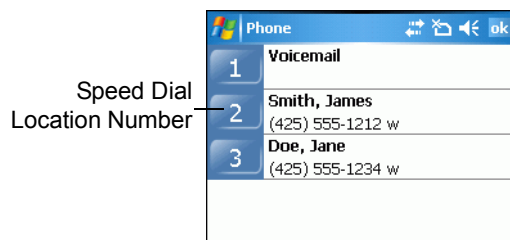





Figure 4-17 Speed Dial Contact List

3. To stop dialing or end the call, tap **End** or press the red dot key on the mobile computer keypad.

Using Call History

Use Call History to call someone who was recently called, or recently called in. Call History provides the time and duration of all incoming, outgoing and missed calls. It also provides a summary of total calls and easy access to notes taken during a call. [Table 4-1](#) list the call history icons that appear in the *Call History* window.

Table 4-1 *Call History Icons*

Icon	Description
	This icon appears next to the contact information for all outgoing calls.
	This icon appears next to the contact information for all incoming calls.
	This icon appears next to the contact information for all missed calls.

To make a call using call history:

1. Tap **Start > Phone** or press the green dot key on the mobile computer's keypad.
2. From the Phone keypad, tap **Call History**.

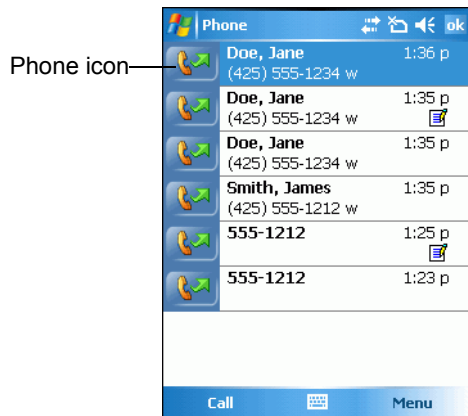

Figure 4-18 *Call History*

3. Tap the phone icon next to the number to begin dialing and return to the phone keypad.
4. Tap **End** or press the red dot key on the mobile computer keypad to stop dialing or end the call.

Managing Call History

Change views, reset the call timer and delete calls to manage the calls stored in Call History.

Changing the Call History View

1. Tap **Start > Phone** or press the green dot key on the mobile computer's keypad to display the Phone keypad.
2. From the Phone keypad, tap **Call History**.

3. Tap **Menu** > **Filter** to show the menu.

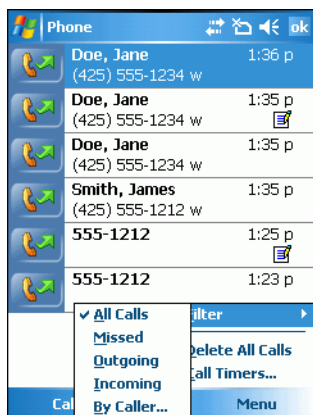

Figure 4-19 Call History - All Calls/Show Menu

4. Select a view type from the menu to display only missed calls, outgoing calls, incoming calls or calls listed alphabetically by caller name.
5. Tap **ok** to exit the **Call History** window.

Resetting the Recent Calls Counter

1. Tap **Start** > **Phone** or press the green dot key on the mobile computer's keypad to display the Phone keypad.
2. From the Phone keypad, tap **Call History**.
3. Tap **Menu**.

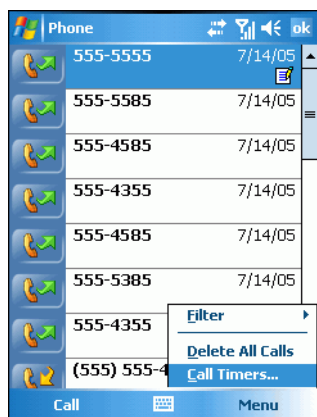

Figure 4-20 Call History - Tools Menu

4. Select **Call Timers...** .

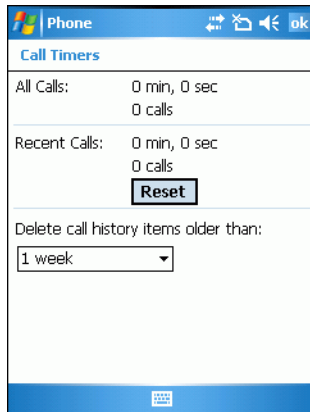

Figure 4-21 Call History - Call Timers

5. Tap **Reset**. (The **All Calls**: counter cannot be reset.)
6. Tap **ok** to exit the **Call Timers** window.

Deleting Call History Items by Call Date

1. Tap **Start** > **Phone** or press the green dot key on the mobile computer's keypad to display the Phone keypad.
2. From the Phone keypad, tap **Call History**.
3. Tap **Menu** > **Call Timers...**

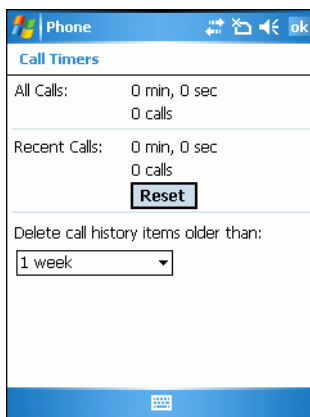

Figure 4-22 Call History - Call Timers

4. In the **Delete call history items older than:** drop-down list, select a time period on which to base deletion of stored items.
5. Tap **ok** to exit the **Call Timers** window.

Deleting All Call History Items

1. Tap **Start** > **Phone** or press the green dot key on the mobile computer's keypad to display the Phone keypad.
2. From the Phone keypad, tap **Call History**.
3. Tap **Menu**.

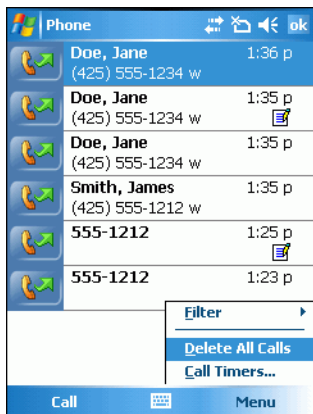

Figure 4-23 Call History - Tools Menu

4. Select **Delete all calls**.

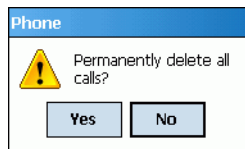

Figure 4-24 Call History - Delete All Dialog

5. Tap **Yes**.

6. Tap **ok** to exit the **Call History** window.

Viewing Call Status

1. Tap **Start** > **Phone** or press the green dot key on the mobile computer's keypad to display the Phone keypad.
2. From the Phone keypad, tap **Call History**.
3. Tap an entry in the list to see the date, time, and duration of a call.

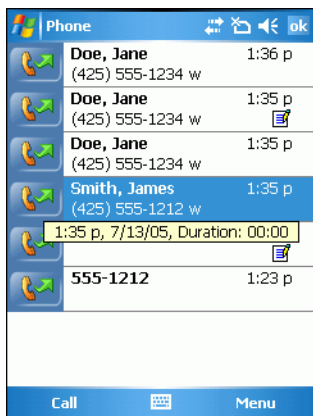

Figure 4-25 Call History - Detail



NOTE When more than one call is on the phone line, only the duration of the first call is recorded.

4. Tap **ok** to exit.

Using the Call History Menu

Use the Call History menu to dial voice mail, access the Activation Wizard, save to contacts, view a note, delete a listing, send an SMS and make a call.

1. Tap **Start > Phone** or press the green dot key on the mobile computer's keypad to display the Phone keypad.
2. From the Phone keypad, tap **Call History**.
3. Tap and hold an item in the list.

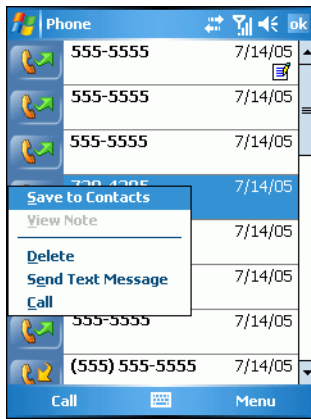

Figure 4-26 Call History - Menu

4. Select an applicable item from the menu, as needed.
5. Depending on the item selected, the appropriate window displays. For example, if **Send SMS** is selected, the **Inbox** window displays.
6. Tap **ok** to exit the *Call History* window.

Using Contacts

Use Contacts to make a call without having to look up or manually enter the phone number.

To make a call from Contacts:

1. Tap **Start > Contacts**.
2. Tap and hold the contact name.

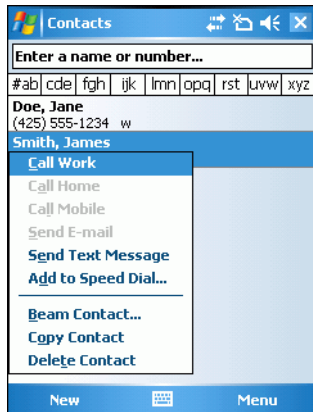

Figure 4-27 Contacts Menu

3. Tap **Call Work**.

✓ **NOTE** To make a call from an open contact, tap the number to call. See On-Device Help for more information about Contacts.

Swapping Calls

To move between two or more phone calls:

1. Tap **Start - Phone** or press the green phone key on the mobile computer's keypad to display the Phone keypad.
2. Enter the first phone number and press **Talk**. When the call connects, **Hold** appears on the keypad.

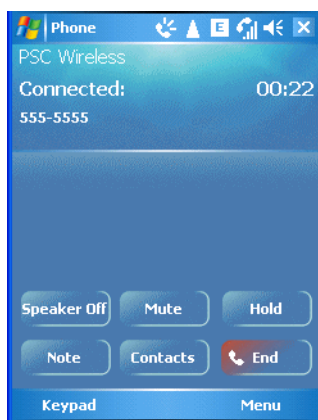

Figure 4-28 Call Swapping - Hold

3. Tap **Hold** to place the first number on hold.
4. Enter the second number and tap **Talk**.

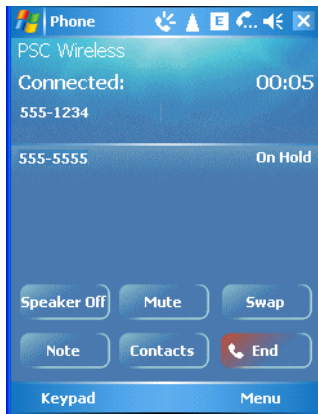

Figure 4-29 *Call Conferencing - Conferencing*

5. Tap **Swap** to move from one call to the other.
6. Tap **End** or press the red phone key on the mobile computer keypad to end each call.

Conference Calling

To create a conference phone session with two or more people and the initiator:

1. Tap **Start > Phone** or press the green phone key on the mobile computer's keypad to display the Phone keypad.
2. Enter the first phone number and press **Talk**. When the call connects, **Hold** appears on the keypad.

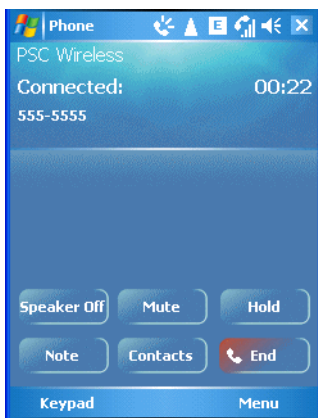

Figure 4-30 *Call Swapping - Hold*

3. Tap **Hold** to place the first number on hold.
4. Enter the second number and tap **Talk**.
5. Tap **Hold** to place the second number on hold.
6. Tap **Menu > Conference** to place the two numbers in conference mode.

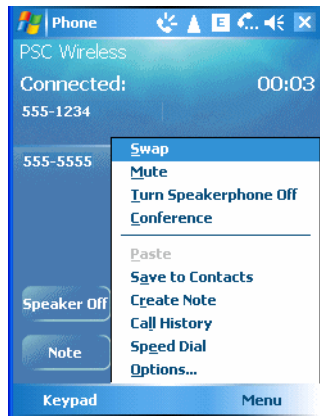

Figure 4-31 *Creating a Conference Call*

7. Tap **End** or press the red phone key on the mobile computer keypad to end the conference call.

✓ **NOTE** To speak privately with one party during a conference call, tap **Menu > Private**. To include all parties again, tap **Menu > Conference**.

Text Messaging

Use the Short Message Service window to send and receive text messages to and from mobile phones. The text can be comprised of words, numbers or an alphanumeric combination no longer than 160 characters.

Short text messages delivered over mobile networks transmit from the sending mobile computer, are stored in a central short message center then forwarded to the destination mobile device. If the recipient is not available, the short message is stored and can be sent later. With the PCS networks based on GSM, CDMA and TDMA technologies supporting SMS, SMS is a universal mobile data service.

Sending a Message

To send a message:

1. Tap **Start > Phone** or press the green dot key on the mobile computer's keypad to display the Phone keypad.
2. Tap **Contacts**.
3. Tap and hold on a contact and select **Send Text Message**.



Figure 4-32 Tools Menu

4. On the *Text Messages* window, enter your message.

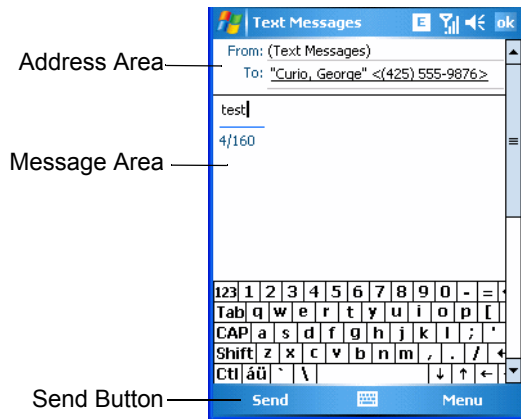



Figure 4-33 Text Messages Window

5. Tap **Send** to send the message.

Establishing a Data Connection

To make a data connection:

1. Ensure a SIM card is installed in the mobile computer.
2. Ensure an GPRS data connection was configured. Refer to the *MC909X Integrator Guide* for instructions on configuring the mobile computer for data connection.
3. Tap  at the top of the screen.

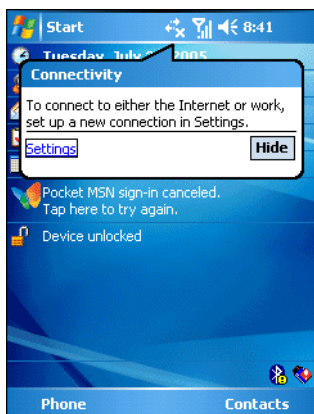

Figure 4-34 Connectivity Dialog

4. Tap **Settings**.
5. Tap **Managing existing connections**.
6. Tap and hold on the data connection until a menu appears.

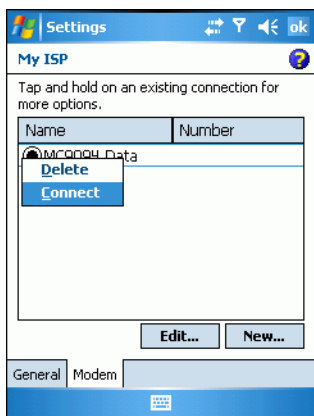

Figure 4-35 Data Connection

7. Select **Connect**.

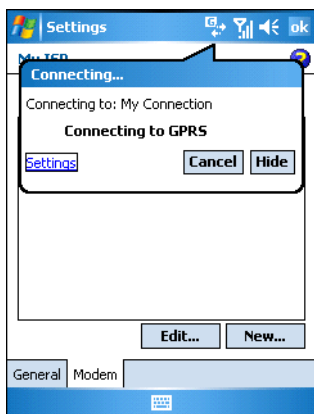

Figure 4-36 Connecting Using GPRS Packet Data Modem

8. If the SIM card is protected with a Personal Identification Number (PIN), a dialog box pops up requesting the appropriate PIN to unlock the SIM card. In this case, enter the PIN and tap **ok**.

✓ **NOTE** Emergency calls can be placed at any time, without requiring a PIN or a SIM card.

9. When a connection is established, launch **Internet Explorer** to browse the Internet or launch an applicable application.

Ending an GPRS Data Connection

To cancel a data connection in progress, tap **Cancel** in the **Connecting...** dialog window.

To end an established data connection:

1. Tap  to display the dialog window.

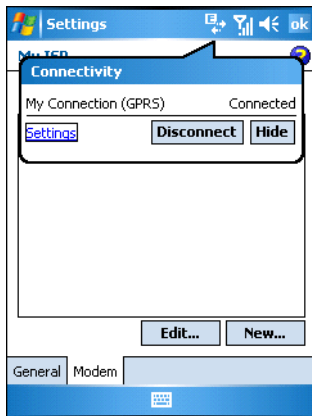

Figure 4-37 Connectivity Dialog Box

2. Tap **Disconnect**.

✓ **NOTE** When **Disconnect** is tapped during an active data transfer (e.g., downloading a web page), the GPRS connection automatically reconnects. The GPRS connection cannot be disconnected until the data transfer is complete.

Chapter 5 Using the MC9097 Phone

Introduction

Use the MC9097 phone to make phone and walkie-talkie calls, set up speed dials and keep track of calls. Your wireless service provider may also provide other services such as voice mail, call forwarding, and caller ID.

Also use the integrated phone to connect to an ISP or work network in order to browse the Web and read e-mail. Connect to the Internet or work network over iDEN using Cellular Line, or using the modem specified by the mobile operator. The MC9097 is a Global Positioning System (GPS) capable device.

For more information, or to customize the phone by changing phone settings, see the *MC909X Integrator Guide*.

Getting Started

Activating Service

Please contact your local network service provider representative for activation.

Phone Properties Page

Information relevant to your phone may be found on these pages. To access phone properties tap **Start > Settings > Phone**. The **Phone Properties** page appears. Refer to the MC909X Integrator Guide for more information.

Finding Your Phone Number and Walkie-Talkie Number

To find your phone number:

1. Tap **Start > Settings > Personal tab > Phone icon > Phone Info tab**.
or
Start > Phone > Tools > Options > Phone tab.

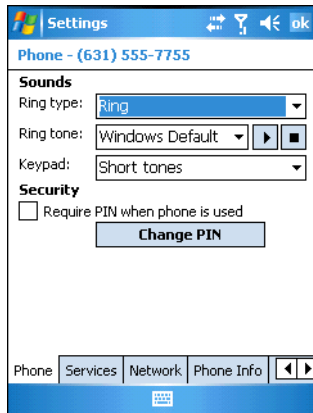

Figure 5-1 MC9097 Phone Window - Phone Tab

2. The phone number is listed at the top of the window after the first call is received.
3. Tap **ok**.

To find your walkie-talkie number:

1. Tap **Start > Settings > Personal tab > Phone icon > Phone Info tab**.

or

Start > Phone > Menu > Options > Phone Info tab.

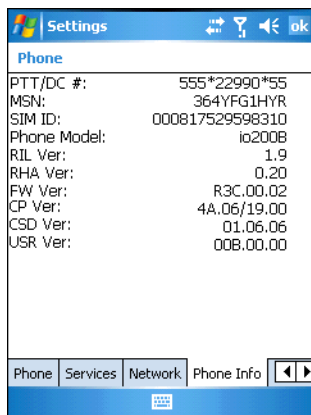

Figure 5-2 MC9097 Phone Window - Phone Info Tab

2. The walkie-talkie number is listed in the first line, **PPT/DC #:**.
3. Tap **ok**.

Accessing the Phone Keypad

The keypad can be accessed regardless of the program in use on the mobile computer. Applications on the mobile computer can be in use during a call.

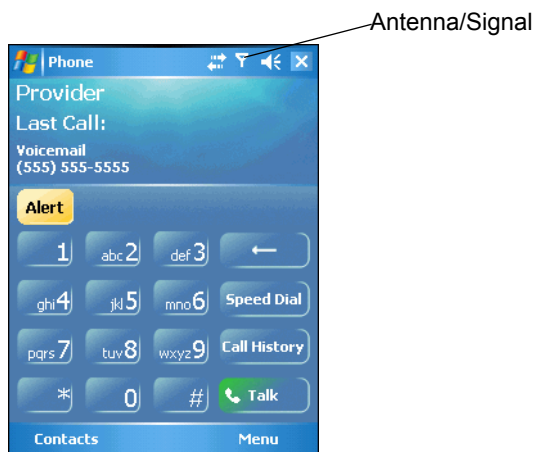

Figure 5-3 MC9097 Phone Keypads

To access the phone keypad tap **Start** > **Phone** or press the green dot key on the mobile computer's keypad.

- ✓ **NOTE** To receive calls when the mobile computer is suspended, leave the phone radio turned on and ensure the mobile computer is set to wake with any key.

Turning the Phone On and Off

With AKU 1.1 (Flight Mode)

- ✓ **NOTE** To determine the operating system AKU version, see [Configurations on page vi](#).

To turn the phone off:

1. Tap  at the top of the screen to display the **Phone** dialog box.

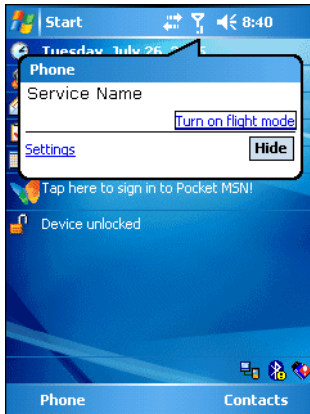

Figure 5-4 Connectivity Dialog Box

2. Tap **Turn on flight mode** to turn the phone off. The phone takes approximately two to five seconds to shut the radio off.

✓ **NOTE** When turning flight mode on the Bluetooth radio is also turned off.

To turn the phone on:

1. Tap  at the top of the screen to display the **Phone** dialog box.

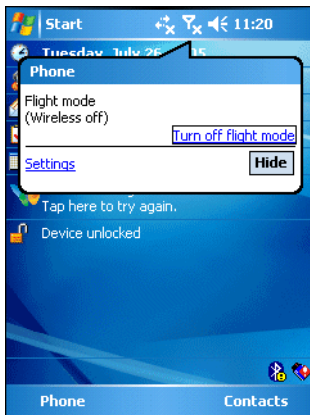

Figure 5-5 Connectivity Dialog Box

2. Tap **Turn off flight mode** to turn the phone on.

It takes 20 to 40 seconds for the radio to power on. During this time, do not suspend the mobile computer or remove the battery. If the mobile computer is suspended or the battery is removed, warm boot the mobile computer.

With AKU 2.2 and Higher

✓ **NOTE** To determine the operating system AKU version, see [Software Versions on page vii](#).

Windows Mobile 5.0 devices with AKU 2.2 and higher include **Wireless Manager**, which provides a simple method of enabling and disabling the phone.

To open **Wireless Manager**, tap the **Connectivity** icon.

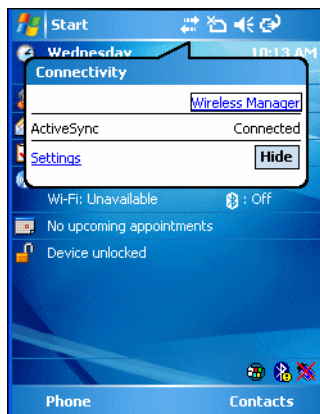

Figure 5-6 *Opening Wireless Manager*

Select **Wireless Manager**. The **Wireless Manager** window appears.



Figure 5-7 *Wireless Manager*

To toggle the phone on or off, tap blue **Phone** bar.

To configure settings for a connection, tap **Menu > Phone Settings**.



NOTE To receive calls when your device is turned off, leave the phone turned on.

Using the Speakerphone and a Headset

You can use the MC9097 with the built-in speakerphone, with a wired headset or a Bluetooth headset. The MC9097 defaults to speakerphone mode. When a wired headset is plugged into the MC9097 audio connector or a Bluetooth headset is configured for use with the MC9097, the speakerphone is muted and audio is heard through the headset.

- ✓ **NOTE** If the mobile computer goes into suspend mode while using a Bluetooth headset, the headset disconnects from the mobile computer. The call is not dropped. The mobile computer defaults back to speakerphone mode.

Adjusting Audio Volume

Use the Volume Control Slider or the keypad keys to adjust the volume of the ringer when not in a call and the audio volume when in a call.

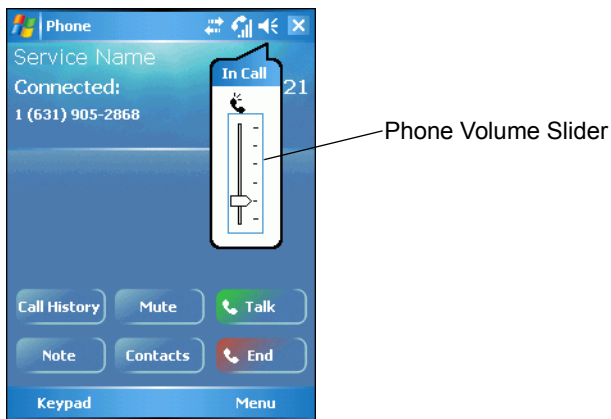



Figure 5-8 Phone Volume Slider

To adjust the volume tap the Speaker icon in the Status Bar. Move the slider up or down to adjust the volume.

- ✓ **NOTE** You cannot adjust the audio volume during a walkie-talkie call. To adjust the volume for a walkie-talkie call, make a regular phone call, adjust the volume during a call and then make a walkie-talkie call. This setting is used on subsequent walkie-talkie calls.

Making a Phone Call

You may access the phone keypad from any application on your mobile computer. You may also access other applications on the mobile computer while you are on a call. When dialing numbers on the mobile computer, use either the stylus to tap numbers on the phone keypad, or use the keypad, located on the bottom half of the device. If the roaming icon  appear at the top of the screen, you must enter the area code before the phone number.

Using the Phone Keypad

To make a call using the phone keypad:

1. Tap **Start** > **Phone** or press the green dot key on the mobile computer's keypad.

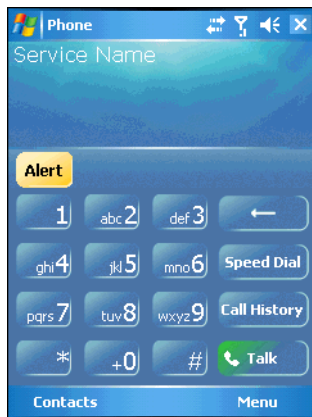

Figure 5-9 Phone Keypad

2. From the Phone keypad, tap the number to call.
3. Tap **Talk**.
4. Tap **End** to stop dialing or end the call.

✓ **NOTE** The green and red dot keys on the mobile computer keypad can also be used to dial (green) and end (red) calls.

Making Calls from Contacts

You may make calls from the **Contacts** window.

To make a call from **Contacts**:

1. Tap **Contacts**, at the bottom of the window. The **Contacts** window appears.
2. Find the contact to call and tap their name. The contact information appears.

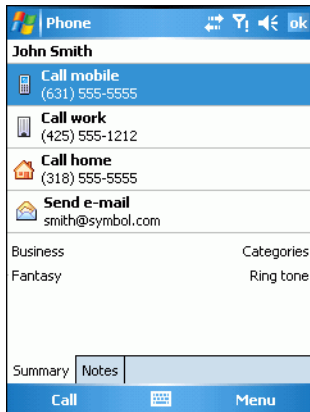

Figure 5-10 Contact Information

3. Select the number to call (i.e., the contact's mobile or home number).
4. Tap **Call**. The mobile computer places the phone call.
5. Tap **End** to terminate the phone call.

Making Calls from Recent Call List

You may access the **Recent Calls** list to make calls.

To make calls from the **Recent Calls** list:

1. Tap **Start > Phone** or press the green dot key on the mobile computer's keypad.
2. Tap **Call History**. The **Call History** window appears.

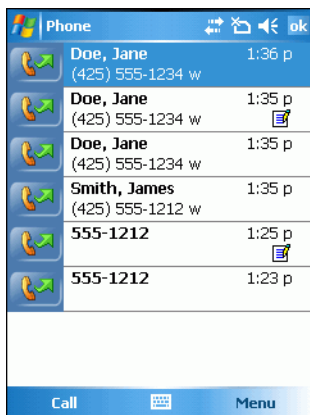

Figure 5-11 Call History Window

3. Tap the phone icon next to the number to begin dialing and return to the phone keypad.
or
Tap the caller information and tap **Call**.
4. Tap **End** or press the red dot key on the mobile computer keypad to stop dialing or end the call.

Receiving Phone Calls

A dialog box appears on the mobile computer's display window when an incoming call is received. If the phone is set to ring, a ring tone sounds. The user has the option to answer the incoming call or ignore the call.

You may choose to answer or ignore any incoming phone calls. When a call is placed to the mobile computer, the **Incoming Calls** dialog box appears. The dialog box also lists the phone number of the person who is calling.

✓ **NOTE** Phone calls are connected without the use of a headset but a headset must be used for all voice communication.

To answer an incoming call:

1. When the phone rings, an **Incoming Call** dialog box appears with the number of the person calling.

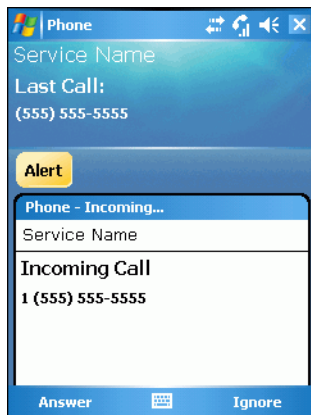

Figure 5-12 *Incoming Call*

2. Tap **Answer** at the bottom of the window or press the green dot key.
3. Begin speaking once the call connects.

To ignore the call:

1. When the phone rings, an **Incoming Call** dialog box appears with the number of the person calling.
2. Tap **Ignore** at the bottom of the window or press the red dot key.
The call is not answered and instead is directed to voice mail.

Walkie-Talkie Calls

Use the mobile computer to make walkie-talkie phone calls to other network subscribers. Every walkie-talkie number has 3 parts - an area ID, a network ID, and a member ID. An asterisk separates each part of the walkie-talkie number. When placing a walkie-talkie call, you must also enter the asterisks as part of the number, i.e., 166*455*8490. If the subscriber you are calling has the same area ID and network ID, you just have to enter the member ID number.

Optimum Walkie-Talkie Usage

When using the MC9097 to make walkie-talkie calls, hold the MC9097 as shown below. When using the left hand, place thumb on Walkie-Talkie button and ensure that your hand does not cover the speaker on the back of the device.

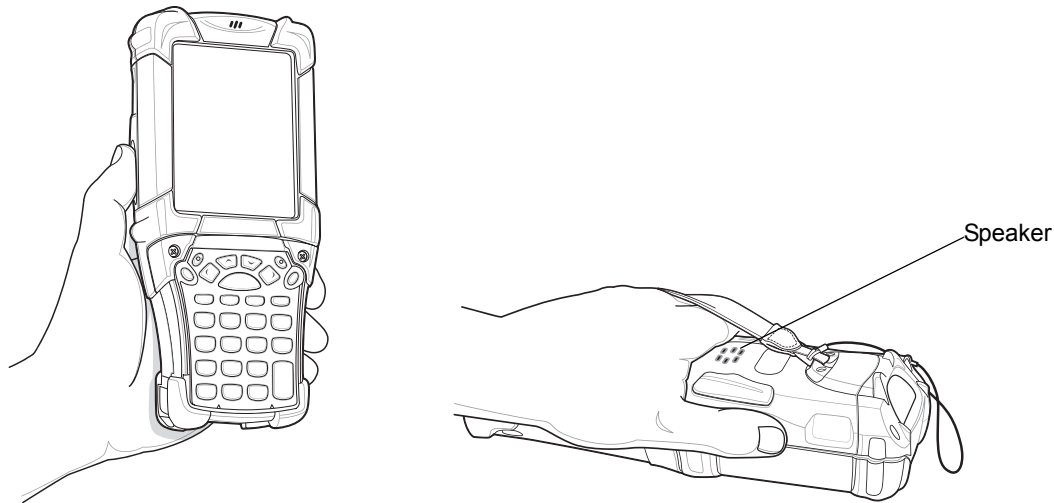

Figure 5-13 Optimum Left Hand Usage

When using the right hand, place the index finger on the Walkie-Talkie button and ensure that your hand does not cover the speaker on the back of the device.

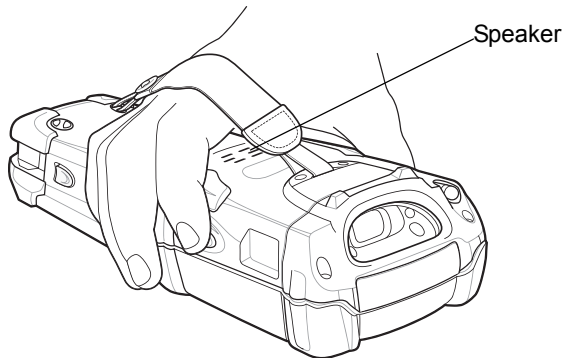

Figure 5-14 Optimum Right Hand Usage

Sending Call Alerts

Sending a call alert lets the recipient know you want to talk to him or her on a walkie-talkie call. When you send a call alert, the recipient's phone emits a series of beeps or vibrations. The phone displays your name or walkie-talkie number.

The recipient can:

- answer the call to begin a walkie-talkie call with the sender
- queue the call to store the call alert to the call alert queue, which is a list of call alerts
- clear the call to dismiss and delete the call alert.

To send a call alert:

1. Tap **Start > Phone** or press the green dot key on the mobile computer's keypad.

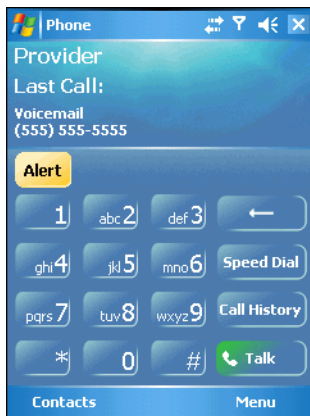

Figure 5-15 Phone Keypad

2. Enter the walkie-talkie number to call.
3. Tap **Alert**. The **Ready to Alert** dialog box appears.

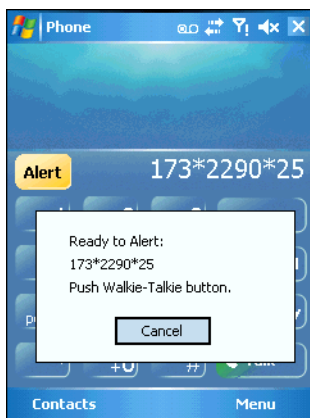

Figure 5-16 Ready To Alert Dialog Box

4. Press the walkie-talkie button on the left side of the mobile computer until the **Alert Successful** dialog box appears.

If the alert is not successful, the person you are trying to reach is on a call or has their phone turned off.

Making Walkie-Talkie Calls

To make a walkie-talkie call:

1. Tap **Start** > **Phone** or press the green dot key on the mobile computer's keypad.

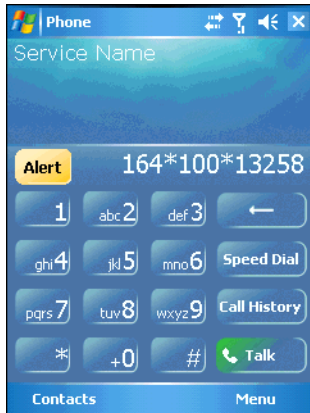

Figure 5-17 Phone Keypad

2. Enter the walkie-talkie number to call.
3. Press and hold the black walkie-talkie button, located on the left side of the mobile computer.

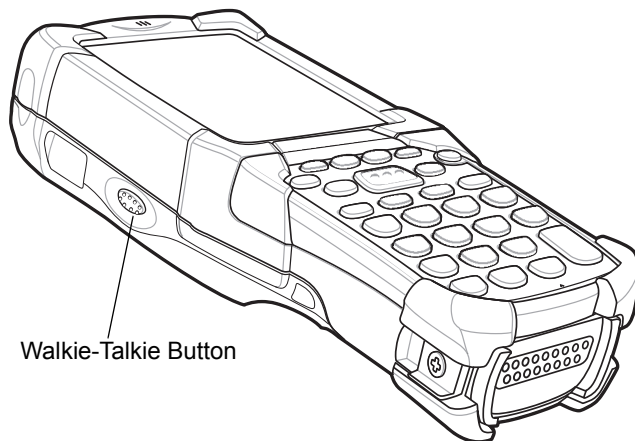

Figure 5-18 Walkie-Talkie Button

4. Begin talking after the mobile computer emits a chirping sound.
5. Release the walkie-talkie button to listen.

✓ **NOTE** A walkie-talkie call ends automatically if there is not activity on the call for a few seconds. To let someone know that you are trying to reach him or her via the walkie-talkie, you may send a call alert (see below).

6. Tap **End** to stop dialing or end the call.

Making Walkie-Talkie Calls from Contacts

You may make walkie-talkie calls from the **Contacts** window.

To make a walkie-talkie call from **Contacts**:

1. Tap **Contacts**, at the bottom of the window. The **Contacts** window appears.

✓ **NOTE** To add a walkie-talkie number to the Contact list, enter the number in the **Radio tel:** field in the **Contact** window.

2. Find the contact to call and tap their name. The contact information appears.

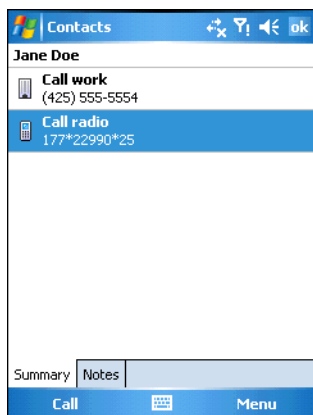

Figure 5-19 Contact Information

3. Select the **Call radio** item.
4. Tap **Call**. The mobile computer places the walkie-talkie call.

Receiving Call Alerts

When you receive a call alert, you must answer, queue, or clear it. You cannot receive phone calls or walkie-talkie calls until you do.



Figure 5-20 Walkie- Talkie Alert

To answer a call alert press the walkie-talkie button to make a walkie-talkie call with the person sending the call alert.

To queue a call alert tap **Queue** when the call alert is incoming.

To clear a call alert tap **Clear** when the call alert is incoming.

- ✓ **NOTE** You may also go to the **Call History** window and clear the call alert there. The call alerts appear as walkie-talkie calls. Call alerts remain in your recent calls list until you delete them or until they reach the end of the list.

Receiving Walkie-Talkie Calls

To receive a walkie-talkie call:

1. The mobile computer emits a chirp when you have an incoming walkie-talkie call.
2. Wait for the caller to finish speaking.
3. To talk, push and hold the walkie-talkie button until you hear a chirp.
4. Begin speaking after the chirp.

- ✓ **NOTE** Ensure to continually push the walkie-talkie button while you are speaking, so that the other party hears you.

5. Release the walkie-talkie button to listen to the person at the other end of the phone call.

Establishing a Data Packet Connection

The iDEN Data Packet settings are pre-configured on the device. Ensure that data packet service is available from your service provider. With a data packet connection you can connect to the internet or transfer data using an application. Refer to the *MC909X Integrator Guide* for information on setting up a data packet connection.

- ✓ **NOTE** When downloading large files through iDEN Packet Data, incoming phone and walkie-talkie call are not received. Phone calls are directed to voicemail. Walkie-talkie calls are notified that you are busy in a data session.

When in a call, Data Packet functions cannot be performed until the call has ended.

The iDEN modem supports a raw maximum data rate of 64 kbps. Typical download speeds including all overhead is approximately 19 kbps.

If the mobile computer is suspended during a data connection the modem does not enter its lowest power state and is not able to receive incoming SMS messages. The incoming message wakes the mobile computer but the actual message is lost.

1. Tap **Start > Internet Explorer**. Internet Explorer launches and the mobile computer connects using the iDEN modem.

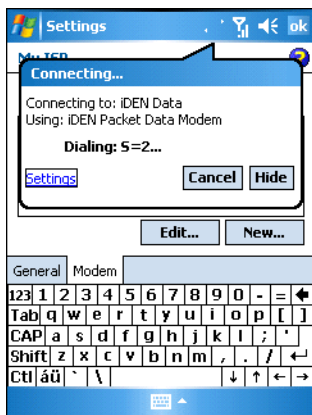

Figure 5-21 Connecting Using iDEN Packet Data Modem

2. When a connection is established, launch **Internet Explorer** to browse the Internet or launch an applicable application.

To end an established data connection:

1. Tap  to display the **Connectivity** dialog window.

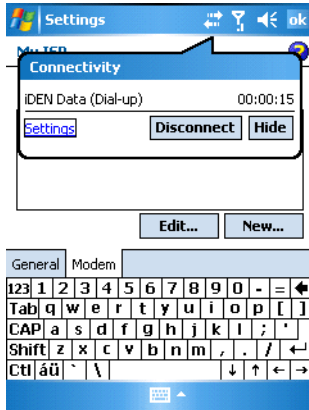

Figure 5-22 *Disconnecting a Data Connection*

2. Tap **Disconnect**.

Phone Options

Creating Notes

Notes can be taken during a call from any window within the Phone application. You can even take notes when you are on another call.

To write notes during a call:

1. Tap **Note** on the display.

The **Notes** window appears listing the phone number and name of the person to whom you are speaking, as well as the date and time of the call.

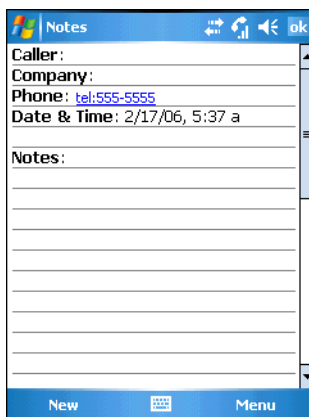

Figure 5-23 *Notes Window*

2. Use the keypad to type your notes.
3. Tap **OK**. The phone application saves the note with the call history of the specific call.

To write notes at any other time:

1. Tap **Start > Phone** or press the green dot key on the mobile computer's keypad.

2. Tap **Menu > Create Note**. The **Notes** window appears with information on the last number you dialed.
3. Type your notes.
4. Tap **OK**. The phone application saves the note with the call history for that particular call.

To access a note created during a call:

1. Tap **Start > Phone** or press the green dot key on the mobile computer's keypad.
2. From the Phone keypad, tap **Call History**.
3. Tap and hold the number or the **Note** icon for the phone call entry containing the note.

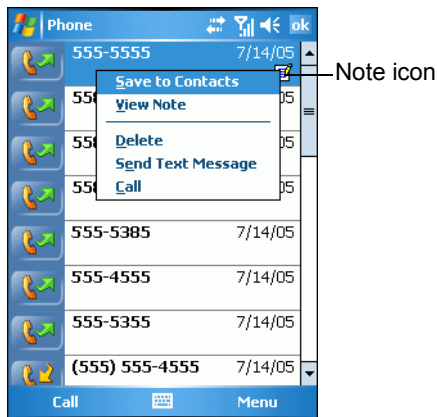

Figure 5-24 Call History - Notes Menu

4. Tap **View Note**.

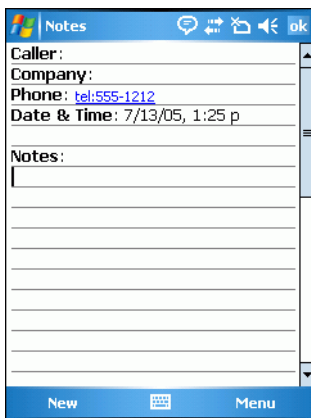

Figure 5-25 Call History - Notes

5. Tap **ok** to exit.



NOTE Notes can also be accessed directly from the Notes application by tapping **Start > Notes**.

Muting a Call

During a call, the microphone can be muted so that the person on the line can be heard but cannot hear conversation from the microphone. This is useful if the user is listening to the person on the line and there's conversation or background noise on the user's end.

To mute or un-mute a call:

1. Answer or place a phone call.

Once the call connects to the other party, the phone keypad displays the **Mute** button.

2. Tap **Mute**. The *Mute* icon appears.

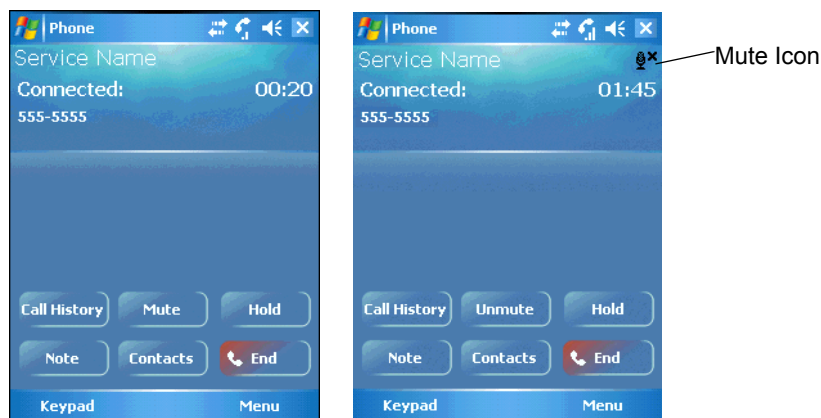

Figure 5-26 Mute/Un-Mute Icon

The mobile computer enables you to hear the other party to whom you are speaking, but stops them from hearing your voice. This is particularly useful on conference calls where you want to hear the discussion but want to block out any background noise that may be present on your end of the line.

3. To resume speaking, tap **UnMute** so that the other party can hear your voice.

Putting Calls on Hold

To put a call on hold:

1. Answer or place a phone call.
2. Once the call connects to the other party, the phone keypad displays the **Hold** button.
3. Tap **Hold**. The call is placed on hold.
4. To resume speaking, tap **UnHold** so that the other party may hear your voice.

Using Speed Dial

To use speed dial:

1. Tap **Start > Phone** or press the green dot key on the mobile computer's keypad.
2. From the Phone keypad, tap and hold the speed dial location number assigned to a contact. (To dial a one-digit speed dial location number, tap and hold the speed dial number. To dial a two-digit speed dial location number, tap the first digit and then tap and hold the second digit.)

or

Tap **Speed Dial**. A list of speed dial numbers appears.

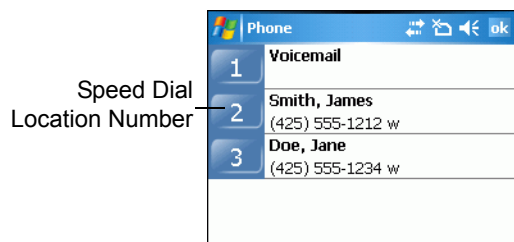

Figure 5-27 Speed Dial List

3. Tap the entry number for the speed dial number.
4. The phone makes the call.
5. To stop dialing or end the call, tap **End** or press the red dot key on the mobile computer keypad.

Add a Speed Dial Entry

To create a speed dial entry from the **Contacts** list:

1. Tap **Start > Phone** or press the green dot key on the mobile computer's keypad.
2. Tap **Speed Dial**. A list of speed dial numbers appears.
3. Tap **Menu > New**. The **Select a Contact** window appears.

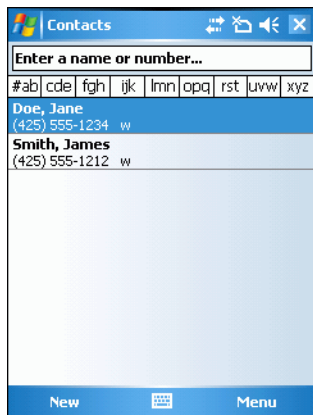

Figure 5-28 Select a Contact Window

4. Tap the contact for which you want to create a new speed dial entry. The **Speed Dial** contact window appears with the name, phone number, and related information of the speed dial contact.

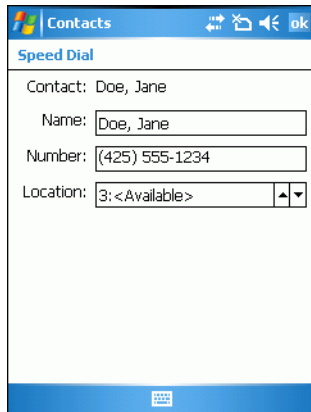

Figure 5-29 Speed Dial Contact Location

5. Tap the up/down arrows to select an available location to assign as the new speed dial entry. The first speed dial location is reserved for voicemail.
6. Tap **OK**. The contact saves to the **Speed Dial** list with the associated speed dial number.

Create a New Speed Dial Entry

To create a new speed dial entry:

1. Tap **Start > Phone** or press the green dot key on the mobile computer's keypad.
2. Tap **Speed Dial**. A list of speed dial numbers appears.
3. Tap **Menu > New**. The **Select a Contact** window appears.
4. Tap **Menu > New Contact**. The **Contact Information** window appears.
5. Enter the contact information in the designated fields.
6. Tap **OK**. The new contact appears on the **Select a Contact** window.
7. Tap the new contact name. The **Speed Dial** contact window appears with the name, phone number, and related information of the speed dial contact.
8. Tap the up/down arrows to select an available location to assign as the new speed dial entry. The first speed dial location is reserved for voicemail.
9. Tap **OK**. The contact saves to the **Speed Dial** list with the associated speed dial number.

Edit a Speed Dial Entry

To edit a speed dial entry:

✓ **NOTE** Editing names and phone numbers in **Speed Dial** does not alter contact information in **Contacts**.

1. Tap **Start > Phone** or press the green dot key on the mobile computer's keypad.
2. Tap **Speed Dial**. A list of speed dial numbers appears.
3. Tap and hold on the speed dial entry to edit and select **Edit** from the pop-up menu. The **Speed Dial** contact window appears.

4. Edit the contact.
5. Tap **OK**. The contact information saves.

Delete a Speed Dial Entry

To delete a speed dial entry:

✓ **NOTE** Deleting names and phone numbers in **Speed Dial** does not delete the contact information in **Contacts**.

1. Tap **Speed Dial**. A list of speed dial numbers appears.
2. Tap and hold on the speed dial entry that you would like to delete and select **Delete** from the pop-up menu.

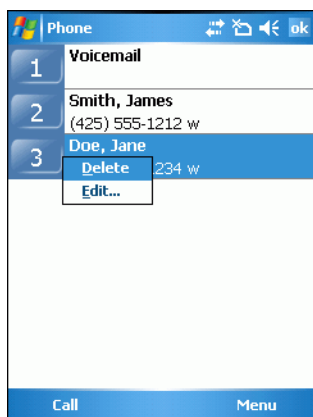

Figure 5-30 Speed Dial Delete Menu

3. The **Delete Speed Dial** confirmation dialog box appears.
4. Tap **Yes**. The speed dial entry is removed from the listing.

Viewing Missed Calls

To view missed calls:

1. If you miss a phone call, the **Missed Calls** window appears.



Figure 5-31 Missed Call Window

2. Tap **View** to see the phone number of the person whose call you missed.
3. Tap the number again to immediately call the person back.

Viewing Call History

Use Call History to call someone who was recently called, or recently called in. Call History provides the time and duration of all incoming, outgoing and missed calls. It also provides a summary of total calls and easy access to notes taken during a call.

To view complete call history:

1. Tap **Call History**. A log of incoming, outgoing, walkie-talkie, and call alert calls appears.

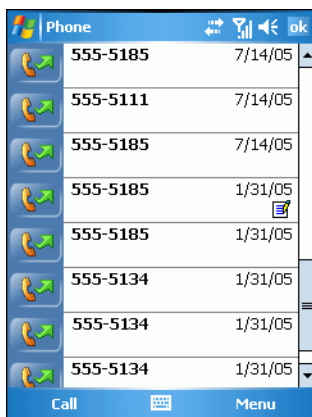

Figure 5-32 Call History Window

2. To make a call, tap the contact that you want to call.
3. Tap **Call**. The mobile computer makes the call.

View Call History by Call Type

To view call history by call type:

1. Tap **Call History**. A log of incoming, outgoing, walkie-talkie, and call alert calls appears.

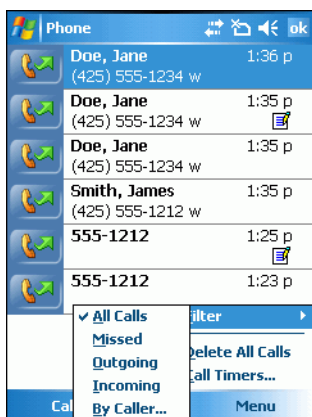

Figure 5-33 Call History Filtering

2. Tap **Menu > Filter**. A pop-up menu appears with **All Calls**, **Missed**, **Outgoing**, **Incoming** and **By Caller** options.

3. Select the call type you want to view (i.e., Outgoing). The **Call History** log for all calls of the selected type appears.

Viewing Call Status

To view call status:

1. Tap **Call History**. A log of incoming, outgoing, walkie-talkie, and call alert calls appears.
2. Tap the contact with the status you want to view. The date, time, and duration of the call appears in a small drop-down window.



Figure 5-34 Call Information

Deleting Calls

To delete all calls:

1. Tap **Call History**. A log of incoming, outgoing, walkie-talkie, and call alert calls appears.
2. Tap **Menu > Delete All Calls**.

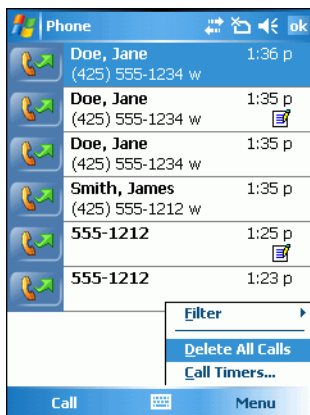

Figure 5-35 Call History - Delete All Calls Menu

3. Select **Delete all calls** from the menu. The **Permanently Delete All Calls** dialog box appears.

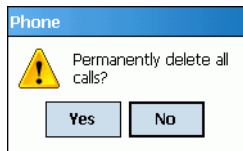

Figure 5-36 Call History - Delete All Dialog

4. Tap **Yes**. The mobile computer deletes the entire call history log.

Deleting Calls Based on Length of Time

To delete calls based on length of time in Call History log:

1. Tap **Call History**. A log of incoming, outgoing, walkie-talkie, and call alert calls appears.
2. Tap **Menu > Call Timers**. The **Call Timers** window appears.

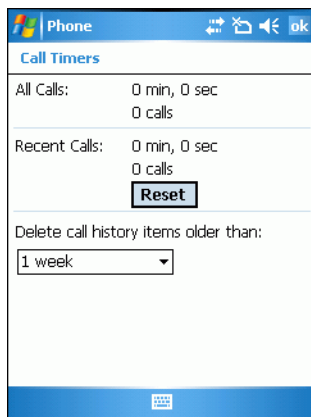

Figure 5-37 Call Timers Window

3. In the **Delete Call History Items Older Than** drop-down menu, select the time frame after which you want all calls to be deleted from the call log (i.e., **1 week**, **1 month**, **Never**).
4. Tap **OK**. The mobile computer deletes the phone calls from the log.

Deleting individual Calls

To delete calls individually:

1. Tap **Call History**. A log of incoming, outgoing, walkie-talkie, and call alert calls appears.
2. Tap the phone number of the call that you want to delete. A drop-down menu appears with the time, date, and duration of the selected call.

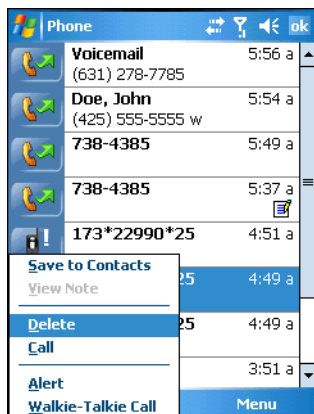

Figure 5-38 Delete Call from Call History

3. Tap and hold the phone number one more time and select **Delete** from the pop-up menu. A dialog box appears with the message **Permanently Delete this Call?**
4. Tap **Yes**. The mobile computer deletes call from the log.

Using Call Timers

1. Tap **Call History**. A log of incoming, outgoing, walkie-talkie, and call alert calls appears.
2. Tap **Menu > Call Timers**. The **Call Timers** window appears.

It details information about the number of calls made, as well as the total time usage for all calls. It also details the number and total time usage of the most recent calls. Note: You may also delete calls based on the time frame that they have been in the Call History. See [Deleting Calls Based on Length of Time on page 5-24](#) for more information.

Chapter 6 Accessories

Introduction

The MC909X accessories provide a variety of product support capabilities. Accessories include cradles, cables and charges.

Keypads

Optional keypads include the interchangeable modular application specific keypads. The modular keypads can be changed in the field as necessary to support specialized applications.

Cradles

- Single Slot Serial/USB cradle charges the mobile computer main battery and a spare battery. It also synchronizes the mobile computer with a host computer through either a serial or a USB connection.
- Four Slot Charge Only cradle charges the mobile computer main battery.
- Four Slot Ethernet cradle charges the mobile computer main battery and synchronizes the mobile computer with a host computer through an Ethernet connection.

Snap-on Modules

- MSR snaps on to the mobile computer and adds magstripe read capabilities.
- CAM snaps on to the mobile computer and is used to connect cables to the mobile computer.

Both of the snap on modules use the cables listed below:

- AC line cord (country-specific) and power supply, charges the mobile computer.
- Auto charge cable, charges the mobile computer using a vehicle's cigarette lighter.
- DEX cable, connects the mobile computer to a vending machine.
- Serial cable, adds serial communication capabilities.
- USB cable, adds USB communication capabilities.
- Printer cable, adds printer communication capabilities.

Keypads

The mobile computer has interchangeable modular keypads. The modular keypads can be changed in the field as necessary to support specialized applications.



CAUTION Do not remove the keypad while the mobile computer is on and do not operate the mobile computer with the keypad detached. Follow proper Electro-Static Discharge (ESD) precautions to avoid damaging the MMC and SD card. Proper ESD precautions include, but are not limited to, working on an ESD mat and ensuring that the operator is properly grounded.

MC9090 keypads are not interchangeable with MC9060 keypads.

Replacing the Keypad

1. Suspend the mobile computer.
2. Remove the two keypad screws. Slide the keypad down and lift up.

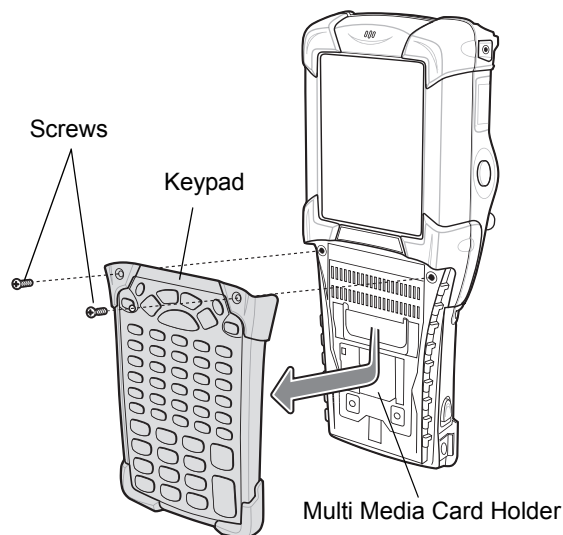

Figure 6-1 Removing the Keypad



CAUTION Do not apply more than 4 in-lbs of torque when tightening the keypad screws.

3. Replace the keypad and re-attach using the two screws.

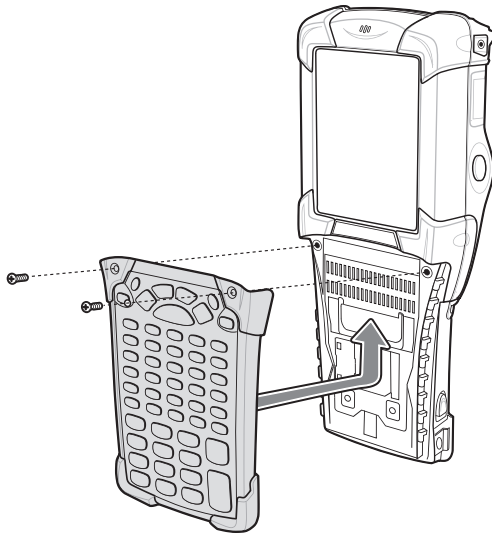

Figure 6-2 *Installing the Keypad*

4. Perform a warm boot.

Multi Media Card (MMC) / Secure Device (SD) Card

The MMC provides secondary non-volatile storage. The MMC is located under the keypad (see [Figure 6-1 on page 6-2](#)).

- ✓ **NOTE** SD cards are inter-operable with MMC cards and can also be used in MC909X mobile computers.

The following supports SD Memory Cards up to 2 GB:

MC909X with Windows Mobile 5.0 and OEM Version 01.39.0001
 MC909X with Windows CE 5.0 and OEM Version 01.26.0001



CAUTION Do not remove the keypad while the mobile computer is on and do not operate the mobile computer with the keypad detached. Follow proper ESD precautions to avoid damaging the MMC/SD. Proper ESD precautions include, but are not limited to, working on an ESD mat and ensuring that the operator is properly grounded.

To insert the MMC/SD:

1. Suspend the mobile computer.
2. Remove the two keypad screws and slide the keypad down and lift off (see [Figure 6-1 on page 6-2](#)).
3. Lift the MMC/SD retaining door.
4. Position the MMC/SD, with the contacts down, into the MMC/SD holder. The MMC/SD corner notch fits into the holder only one way. Snap the retaining door closed.

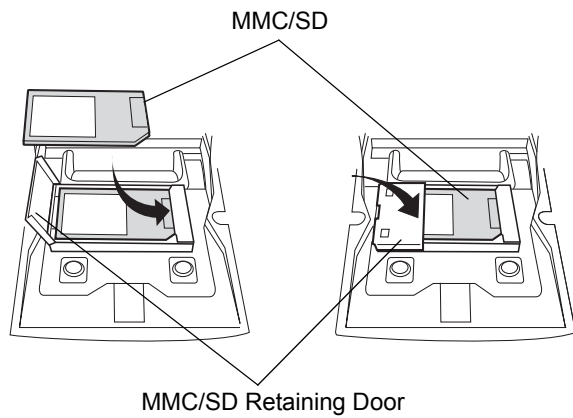

Figure 6-3 *Inserting the MMC/SD*



CAUTION Do not apply more than 4 in-lbs of torque when tightening the keypad screws.

5. Replace the keypad and re-attach using the two screws (see [Figure 6-2 on page 6-3](#)).
6. Perform a warm boot.

Single Slot Serial/USB Cradle



CAUTION Ensure that you follow the guidelines for battery safety described in [Battery Safety Guidelines on page 7-1](#).

This section describes how to use a single Single Slot Serial/USB cradle ([Figure 6-4](#)) with the mobile computer. For serial and USB communication setup procedures refer to the *MC909X Integrator Guide*.

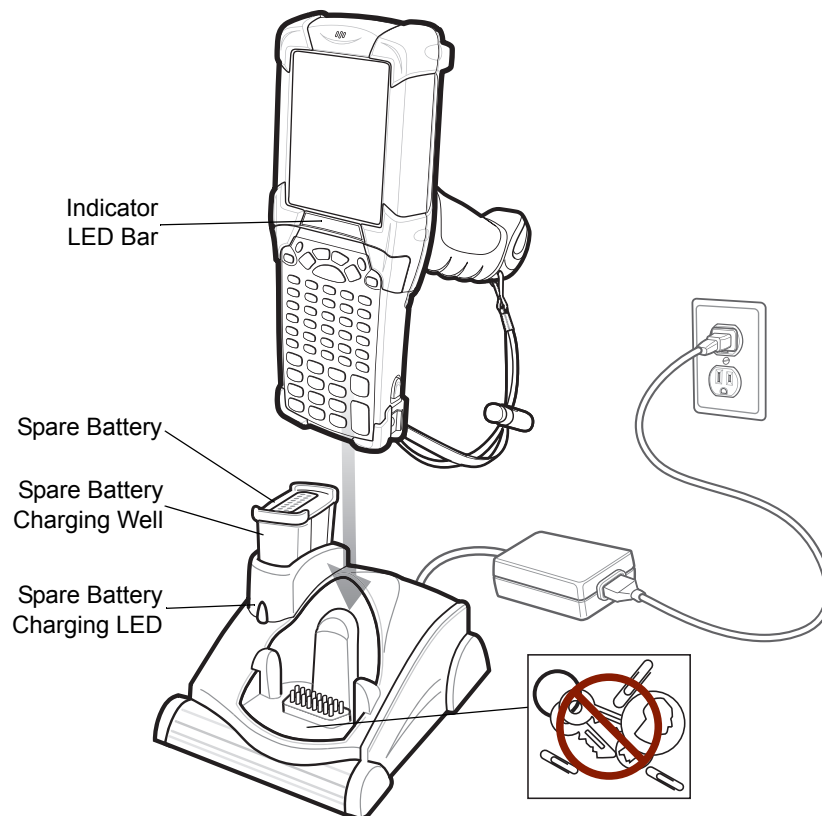

Figure 6-4 Single Slot Serial/USB Cradle



CAUTION Do not place coins, keys or paper clips in cradle well.

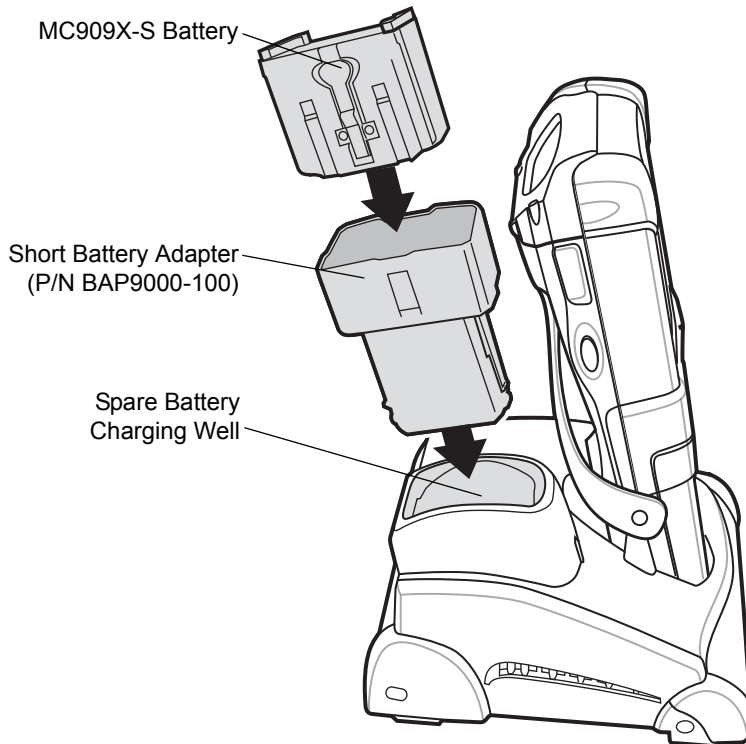

Figure 6-5 MC909X-S Spare Battery Charging



CAUTION Use only an approved power supply output rated 12 VDC and minimum 3.3 A. Use of an alternative power supply will void the product warranty and may cause product damage. See [Appendix C, Regulatory](#) for the power supply regulatory compliance statement.

The Single Slot Serial/USB Cradle has the following attributes:

- Provides 15VDC power for operating the mobile computer.
 - Provides serial and USB ports for data communication between the mobile computer and a host computer or other serial devices (e.g., a printer).
- ✓ **NOTE** When a mobile computer with Microsoft Mobile 5.0 is placed in the cradle and an ActiveSync connection is made, the WLAN and WWAN radios (if applicable) are disabled. This is a Microsoft security feature to prevent connection to two networks at the same time.
- Synchronizes information between the mobile computer and a host computer. (With customized or third party software, it can also be used to synchronize the mobile computer with corporate databases.)
 - Charges the mobile computer's battery.
 - Charges a spare battery.

Battery Charging Indicators

The the Single Slot Serial/USB Cradle can charge the mobile computer's main battery and a spare battery simultaneously.

The mobile computer's amber charge LED, located in the Indicator LED Bar, shows the status of the battery charging in the mobile computer. See [Table 1-2 on page 1-8](#) for charging status indications.

The amber spare battery charging LED on the cradle (see [Figure 6-4 on page 6-5](#)) shows the status of the spare battery charging in the cradle. See [Table 6-2](#) for charging status indications.

Batteries usually charge in less than four hours.

Table 6-1 Spare Battery LED Charging Indicators

Spare Battery LED (on cradle)	Indication
Off	No spare battery in well; spare battery not placed correctly; cradle is not powered.
Fast Blinking Amber	Error in charging; check placement of spare battery.
Slow Blinking Amber	Spare battery is charging.
Solid Amber	Charging complete.

Four Slot Ethernet Cradle



CAUTION Ensure that you follow the guidelines for battery safety described in [Battery Safety Guidelines on page 7-1](#).

This section describes how to use a Four Slot Ethernet cradle with the mobile computer.

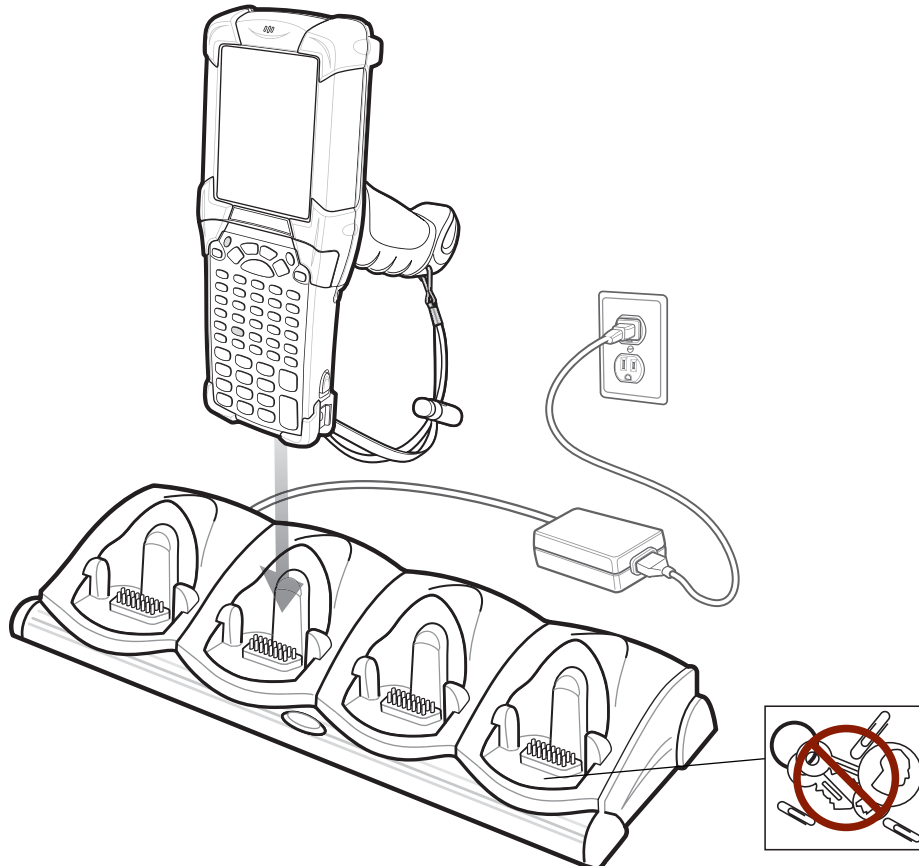

Figure 6-6 Four Slot Ethernet Cradle (MC9090-G Shown)



CAUTION Do not place coins, keys or paper clips in cradle well.



CAUTION Use only an approved power supply output rated 12 VDC and minimum 9 A. Use of an alternative power supply will void the product warranty and may cause product damage. See [Appendix C, Regulatory](#) for the power supply regulatory compliance statement.

The Four Slot Ethernet cradle has the following attributes:

- Provides 12VDC power for operating the mobile computer.
 - Enables data communication between the mobile computer (up to four) and a host computer, over an Ethernet network (using a standard 10Base-T Ethernet cable).
- ✓ **NOTE** When a mobile computer with Microsoft Mobile 5.0 is placed in the cradle and an ActiveSync connection is made, the WLAN and WWAN radios (if applicable) are disabled. This is a Microsoft security feature to prevent connection to two networks at the same time.
- Synchronizes information between the mobile computer and a host computer. (With customized or third party software, it can also be used to synchronize the mobile computer with corporate databases.)
 - Simultaneously charges up to four batteries in the mobile computer.

Battery Charging Indicators

The mobile computer's amber charge LED, located in the Indicator LED Bar, shows the status of the battery charging in the mobile computer. See [Table 1-2 on page 1-8](#) for charging status indications.

The battery usually charges in less than four hours.

Four Slot Charge Only Cradle



CAUTION Ensure that you follow the guidelines for battery safety described in [Battery Safety Guidelines on page 7-1](#).

This section describes how to use a Four Slot Charge Only cradle with the mobile computer.

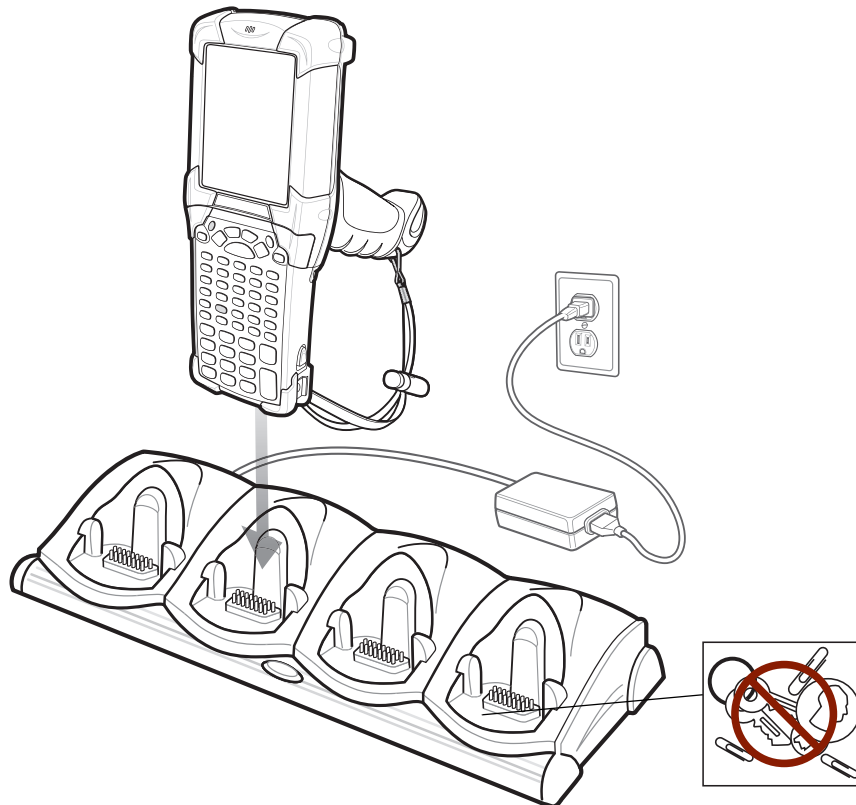

Figure 6-7 Four Slot Charge Only Cradle (MC909X-G Shown)



CAUTION Do not place coins, keys or paper clips in cradle well.



CAUTION Use only an approved power supply output rated 12 VDC and minimum 9 A. Use of an alternative power supply will void the product warranty and may cause product damage. See [Appendix C, Regulatory](#) for the power supply regulatory compliance statement.

The Four Slot Charge Only cradle has the following attributes:

- Provides 12VDC power for operating the mobile computer.
- Simultaneously charges up to four batteries in the mobile computer.

Battery Charging Indicators

The mobile computer's amber charge LED, located in the Indicator LED Bar, shows the status of the battery charging in the mobile computer. See [Table 1-2 on page 1-8](#) for charging status indications.

The battery usually charges in less than four hours.

Four Slot Spare Battery Charger



CAUTION Ensure that you follow the guidelines for battery safety described in [Battery Safety Guidelines on page 7-1](#).

This section describes how to use the Four Slot Spare Battery Charger to charge up to four MC909X spare batteries.

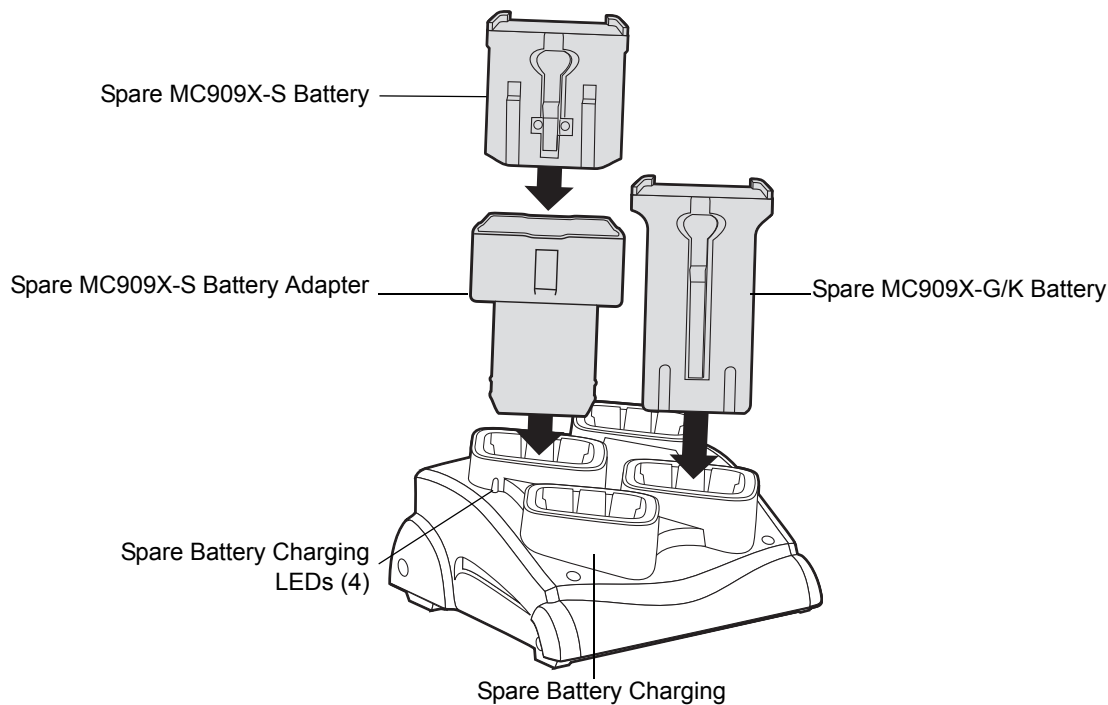

Figure 6-8 Four Slot Spare Battery Charger



CAUTION Use only an approved power supply output rated 15 VDC and minimum 5 A. Use of an alternative power supply will void the product warranty and may cause product damage. See [Appendix C, Regulatory](#) for the power supply regulatory compliance statement.

Spare Battery Charging with the Four Slot Spare Battery Charger

Insert the battery into a spare battery charging slot and gently press down on the battery to ensure proper contact.

Battery Charging Indicators

An amber LED is provided on each battery charging well. See [Table 6-1](#) for charging status indications.

The battery usually charges in less than four hours.

Table 6-2 Spare Battery LED Charging Indicators

LED	Indication
Off	No spare battery in slot; spare battery not placed correctly; cradle is not powered.
Fast Blinking Amber	Error in charging; check placement of spare battery.
Slow Blinking Amber	Spare battery is charging.
Solid Amber	Charging complete.

Magnetic Stripe Reader

This section describes how to set up and use the snap-on MSR with the mobile computer. The MSR snaps on to the bottom of the mobile computer and can be easily removed when not in use.

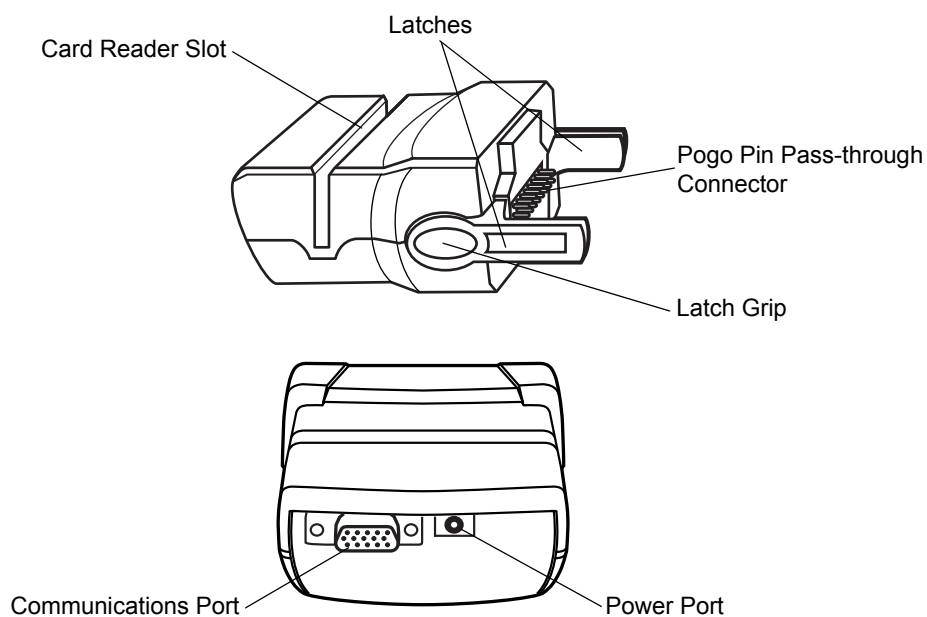

Figure 6-9 Magnetic Stripe Reader



CAUTION Use only an approved power supply output rated 12 VDC and minimum 3.3 A. Use of an alternative power supply will void the product warranty and may cause product damage. See [Appendix C, Regulatory](#) for the power supply regulatory compliance statement.

When attached to the mobile computer, the MSR has the following attributes:

- Provides power for operating the mobile computer, with the appropriate power connection.
- Allows the mobile computer to capture data from magnetic stripe cards. (To download MSR data capture software, visit: <http://developer.zebra.com>.)

- ✓ **NOTE** When a mobile computer with Windows Mobile 5.0 is connected to a host computer through the MSR and an ActiveSync connection is made, the WLAN and WWAN radios (if applicable) are disabled. This is a Microsoft security feature to prevent connection to two networks at the same time.
- Provides serial connection through the serial pass-through port for communication with a serial device, such as a host computer.
 - Provides USB connection through the USB pass-through port for communication with a USB device, such as a host computer.
 - Charges the mobile computer's battery, when used with the appropriate power supply.

Attaching and Removing

To attach, snap the MSR onto the bottom of the mobile computer.

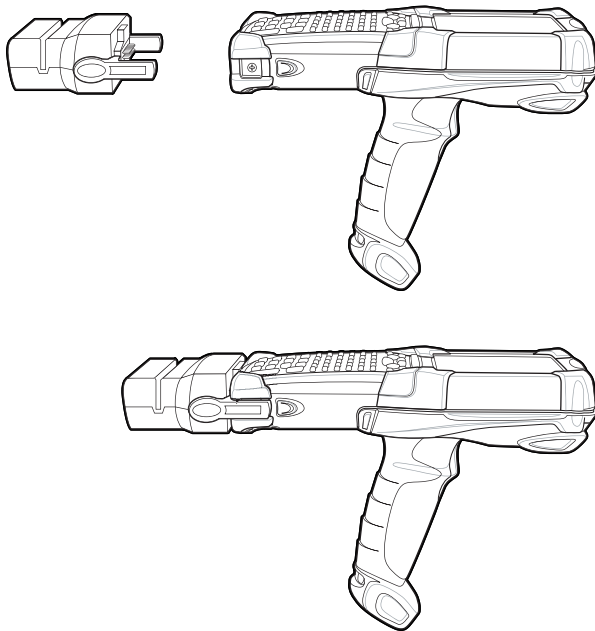

Figure 6-10 Attaching the MSR (MC909X-G shown)

To remove, squeeze the latch grips and pull the MSR from the mobile computer.

- ✓ **NOTE** Remove the MSR from the bottom of the mobile computer before using a cradle for charging and communication.

Setup

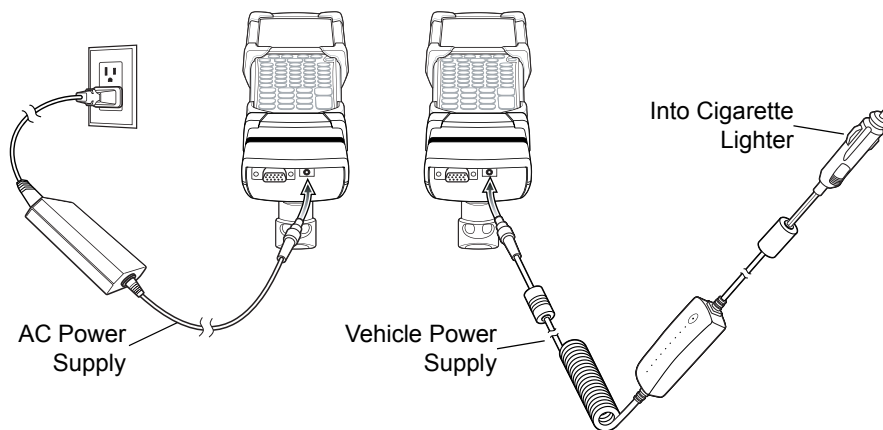

Figure 6-11 MSR Power Connection

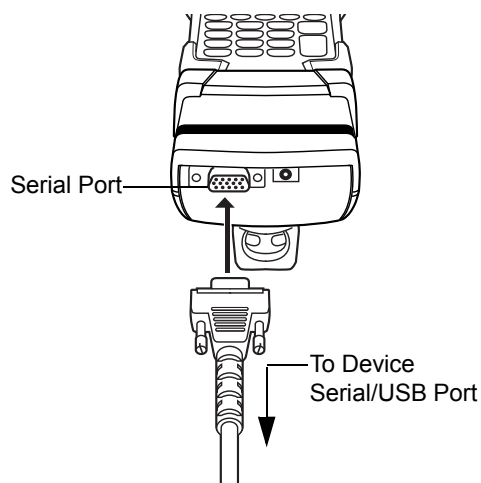

Figure 6-12 MSR Serial/USB Connection

Battery Charging Indicators

To charge the mobile computer's battery through the MSR, connect the power supply to the MSR (see [Figure 6-11 on page 6-13](#)), then attach the MSR to the mobile computer. The mobile computer begins charging automatically.

✓ **NOTE** Batteries must be charged within the 32° to 104° F (0° to +40° C) ambient temperature range.

The mobile computer's amber charge LED, located in the Indicator LED Bar, shows the status of the battery charging in the mobile computer. See [Table 1-2 on page 1-8](#) for charging status indications.

The battery usually charges in less than four hours, if the mobile computer is not in use.

Serial/USB Connection

The MSR can connect to and communicate with a serial/USB device, such as a printer or host computer, through its serial port.

To connect the MSR to a serial/USB device, connect one end of the serial device cable into the serial port on the MSR and the other end into the serial/USB port on the device.

Using the MSR

The *MSR9000* sample application is designed to work with the MSR. This sample application illustrates how an application should handle MSR inputs.

✓ **NOTE** The MSR does not need to be attached to the power supply to read magnetic stripes.

To use the MSR:

1. Attach the MSR to the mobile computer (see [Attaching and Removing on page 6-12](#)).
2. Power on the mobile computer.
3. Launch an MSR enabled application.
4. Swipe the magnetic stripe card through the MSR, ensuring the magnetic stripe on the card faces the mobile computer. The card may be swiped in either direction, from left to right or from right to left. For best results, gently press down on the card while swiping to ensure contact with the bottom of the reader.

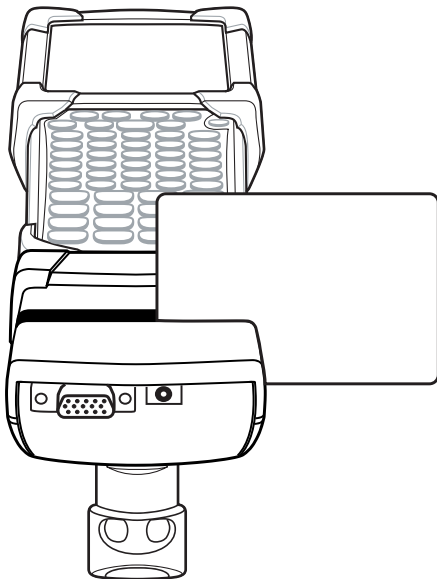

Figure 6-13 *Magnetic Stripe Card Swiping*

Cable Adapter Module

This section describes how to set up and use the snap-on CAM with the mobile computer. The CAM snaps on to the bottom of the mobile computer and can be easily removed when not in use.

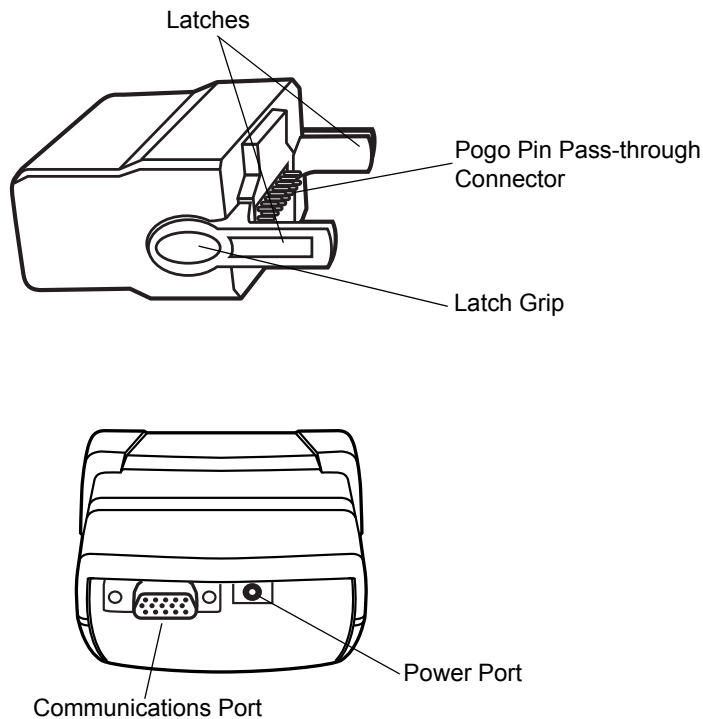

Figure 6-14 Cable Adapter Module



CAUTION Use only an approved power supply output rated 12 VDC and minimum 3.3 A. Use of an alternative power supply will void the product warranty and may cause product damage. See [Appendix C, Regulatory](#) for the power supply regulatory compliance statement.

When attached to the mobile computer, the CAM can perform the following functions.

- Provides power for operating the mobile computer, with the appropriate power connection.
- ✓ **NOTE** When a mobile computer with Windows Mobile 5.0 is connected to a host computer through the CAM and an ActiveSync connection is made, the WLAN and WWAN radios (if applicable) are disabled. This is a Microsoft security feature to prevent connection to two networks at the same time.
- Provides serial connection through the serial pass-through port for communication with a serial device, such as a host computer.
- Provides USB connection through the USB pass-through port for communication with a USB device, such as a host computer.
- Charges the mobile computer's battery, when used with the appropriate power supply.

Attaching and Removing

To attach, snap the CAM onto the bottom of the mobile computer.

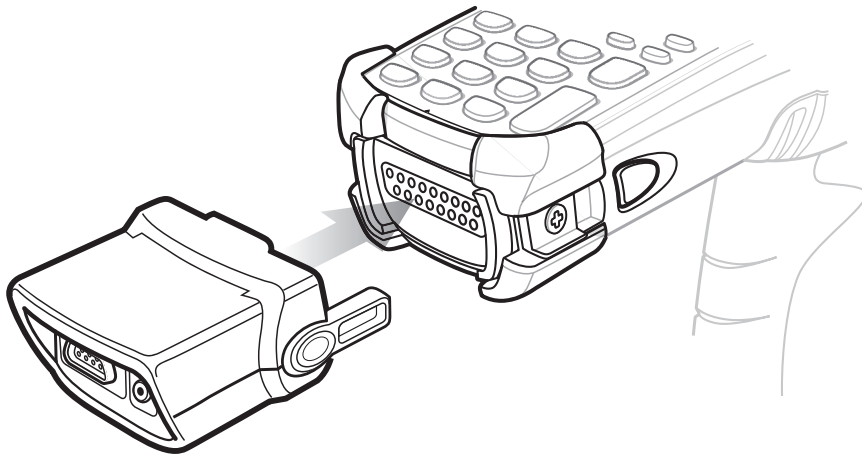

Figure 6-15 Attaching the CAM (MC909X-G shown)

To remove, squeeze the latch grips and pull the CAM from the mobile computer.

✓ **NOTE** Remove the CAM from the bottom of the mobile computer before using a cradle for charging and communication.

Setup

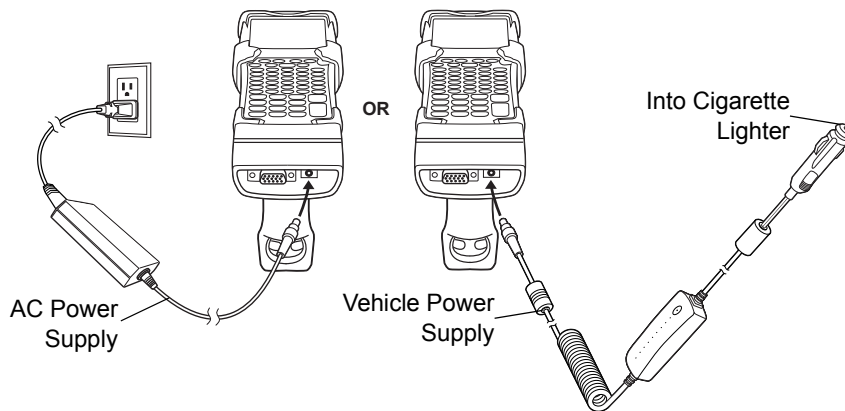

Figure 6-16 CAM Power Connection

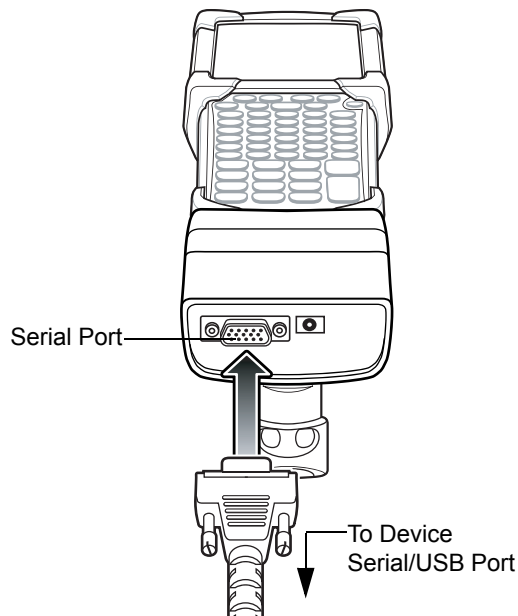

Figure 6-17 CAM Serial Connection

Battery Charging Indicators

To charge the mobile computer's battery through the CAM, connect the power supply to the CAM (see [Figure 6-16 on page 6-16](#)), then attach the CAM to the mobile computer. The mobile computer begins charging automatically.

✓ **NOTE** Batteries must be charged within the 32° to 104° F (0° to +40° C) ambient temperature range.

The mobile computer's amber charge LED, located in the Indicator LED Bar, shows the status of the battery charging in the mobile computer. See [Table 1-2 on page 1-8](#) for charging status indications.

The battery usually charges in less than four hours, if the mobile computer is not in use.

Serial/USB Connection

The CAM can connect to and communicate with a serial/USB device, such as a printer or host computer, through its serial port.

To connect the CAM to a serial/USB device, connect one end of the serial device cable into the serial port on the CAM and the other end into the serial/USB port on the device.

Universal Battery Charger (UBC) Adapter



CAUTION Ensure that you follow the guidelines for battery safety described in [Battery Safety Guidelines on page 7-1](#).

This section describes how to use the UBC adapter to charge a spare battery.

The UBC can be used with a power supply as a standalone spare battery charger or it can be used with the four station UBC2000 to provide charging to simultaneously charge up to four spare batteries. For additional information about the UBC2000, see the *UBC 2000 Universal Battery Charger Product Guide* (p/n 70-33188-xx).

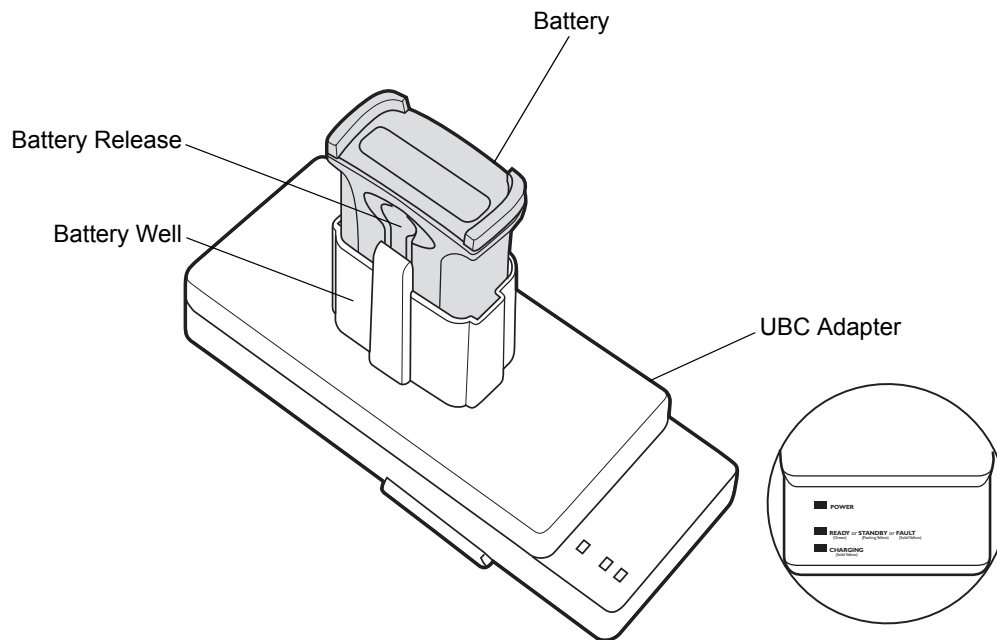

Figure 6-18 UBC Adapter

Inserting and Removing a Battery

Insert the battery into the battery well with the charging contacts facing down (over charging pins) and gently press down on the battery to ensure proper contact.

To remove the battery, press the battery release and lift battery out of the well.



CAUTION Use only an approved power supply output rated 15 VDC and minimum 1.5 A. Use of an alternative power supply will void the product warranty and may cause product damage. See [Appendix C, Regulatory](#) for the power supply regulatory compliance statement.

Battery Charging Indicators

To charge a spare battery using the UBC adapter, connect the power supply to the UBC, then insert the spare battery. The spare battery begins charging automatically.

The UBC's charge LEDs (see [Figure 6-19](#)) show the status of the battery charging in the adapter. [Table 6-1](#) shows battery charging status indications.

The battery usually charges in three hours.

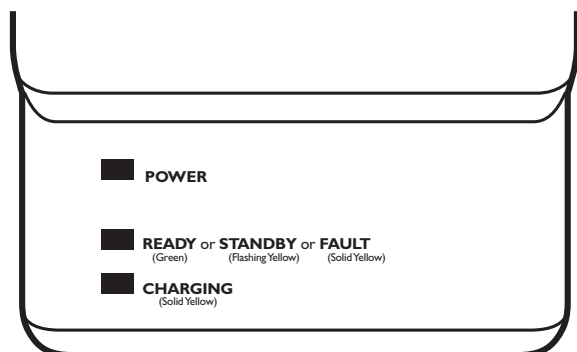

Figure 6-19 UBC Adapter LEDs

Table 6-3 UBC Adapter Charge LED Status Indications

LED	Indication	Description
POWER	Green	Power is connected to the UBC Adapter.
READY or	Green	Charging complete.
STANDBY or	Flashing-Yellow	The battery was deeply discharged and is being trickle charged to bring the voltage up to the operating level. After operating level voltage is achieved the battery charges normally.
FAULT	Yellow	Charging error, check placement of mobile computer/spare battery.
CHARGING	Yellow	Normal charge.

Modem Module

This section describes how to setup and use the MDM9000 Modem Module.

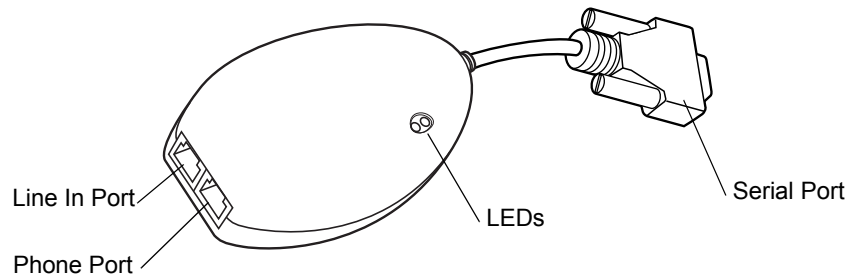

Figure 6-20 Modem Module

The Modem Module enables data communication between the mobile computer and a host computer, remotely through the phone lines, and synchronizes information between the mobile computer and a host computer.

The following items are required for a modem connection:

- Telephone number, IP address and DNS/WINS address information from the dial-in server administrator
- Dial-in account on the host system, including a user ID and password
- RJ11 or RJ12 modem cable
- Functioning telephone jack that supports plug-in modems connected to the local telephone system
- Setup of Country Codes to use the modem with the appropriate country's telephone network.

The following items are required for communication:

- MC9090-G Series mobile computer
- Cable Adapter Module (CAM), Zebra p/n ADP9000-100 (see [Cable Adapter Module on page 6-15](#))
- Serial Adapter Cable (for communication via cradle), Zebra p/n 25-63856-01
- Microsoft ActiveSync
- Setup of host computer and mobile computer.

Setup

Connecting to the Mobile Computer

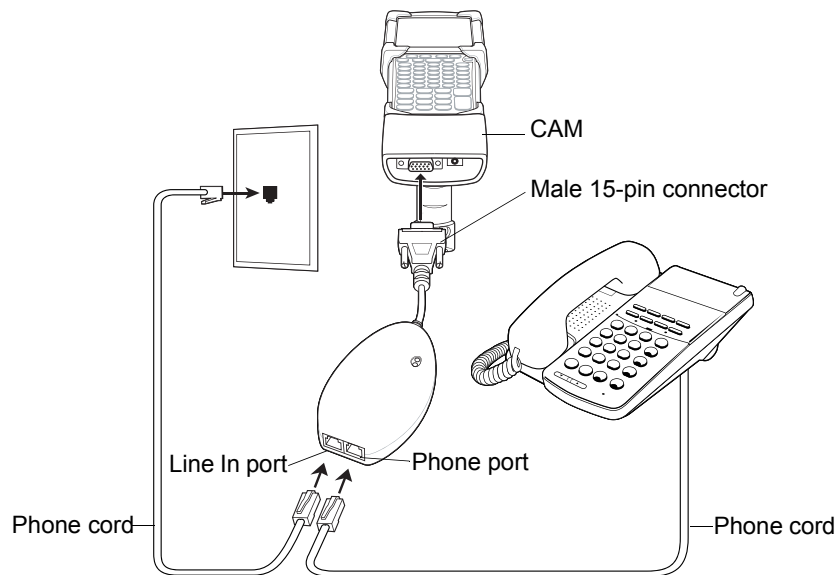

Figure 6-21 Modem Module Connection - Mobile Computer



CAUTION Do not connect the modem's 15-pin connector into a VGA port of a host computer.

Using the Correct Telephone Line Type

Use a standard analog phone line, as in most households. In an office, use a line connected to a fax machine or modem. In a hotel, request a room with a standard phone line or data port. If necessary, check with the local phone company or administrator to make sure you are using the right type of line before sending data.

Connecting to the Single Slot Serial/USB Cradle

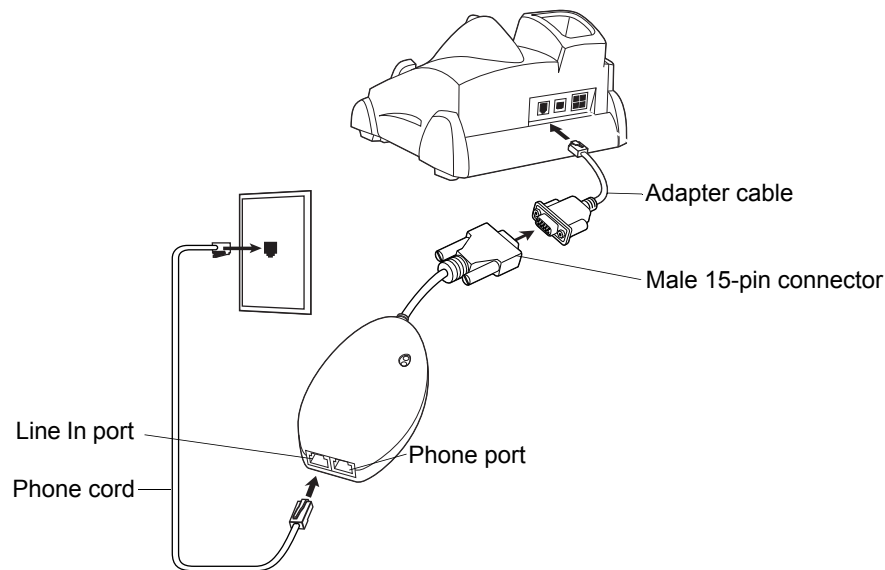

Figure 6-22 Modem Module Connection - Single Slot Serial/USB Cradle



CAUTION Do not connect the modem's 15-pin connector into a VGA port of a host computer.



NOTE If using a phone, connect the cord from the phone to the Phone port on the modem.

Table 6-4 Modem LED Indicator

LED	Indication
Off	Modem is not properly connected to the mobile computer; modem is not receiving power.
Green	Modem is connected to the mobile computer and is receiving power.
Solid Amber	Mobile computer is communicating with the host computer.

Chapter 7 Maintenance & Troubleshooting

Introduction

This chapter includes instructions on cleaning and storing the mobile computer, and provides troubleshooting solutions for potential problems during mobile computer operation.

Maintaining the Mobile Computer

For trouble-free service, observe the following tips when using the mobile computer:

- Protect the mobile computer from temperature extremes. Do not leave it on the dashboard of a car on a hot day, and keep it away from heat sources.
- Do not store or use the mobile computer in any location that is extremely dusty, damp, or wet.
- Use a soft lens cloth to clean the mobile computer. If the surface of the mobile computer screen becomes soiled, clean it with a soft cloth moistened with a diluted window-cleaning solution.
- Periodically replace the rechargeable Li-ion battery to ensure maximum battery life and product performance. Battery life depends on individual usage patterns.
- Take care not to scratch the screen of the mobile computer. When working with the mobile computer, use the supplied stylus or plastic-tipped pens intended for use with a touch-sensitive screen. Never use an actual pen or pencil or other sharp object on the surface of the mobile computer screen.
- The touch-sensitive screen of the mobile computer contains glass. Take care not to drop the mobile computer or subject it to strong impact.

Battery Safety Guidelines

- The area in which the units are charged should be clear of debris and combustible materials or chemicals. Particular care should be taken where the device is charged in a non-commercial environment.
- Do not use incompatible batteries and chargers. If you have any questions about the compatibility of a battery or a charger, contact Zebra support. See [Service Information on page xii](#) for contact information.
- Do not crush, puncture, or place a high degree of pressure on the battery.

- Severe impact from dropping any battery-operated device on a hard surface could cause the battery to overheat.
- Do not leave or store the equipment in or near areas that might get very hot, such as in a parked vehicle or near a radiator or other heat source. Do not place battery into a microwave oven or dryer.
- Do not dispose of batteries in fire.
- If you suspect damage to your equipment or battery, call Zebra support to arrange for inspection. See [Service Information on page xii](#) for contact information.

Troubleshooting

Mobile Computer

Table 7-1 *Troubleshooting the Mobile Computer*

Problem	Cause	Solution
Mobile computer does not turn on.	Lithium-ion battery not charged.	Charge or replace the lithium-ion battery in the mobile computer.
	Lithium-ion battery not installed properly.	Ensure battery is installed properly. See Installing and Removing the Main Battery on page 1-6 .
	System crash.	Perform a warm boot. If the mobile computer still does not turn on, perform a cold boot. See Resetting the Mobile Computer on page 2-49 .
Rechargeable lithium-ion battery did not charge.	Battery failed.	Replace battery. If the mobile computer still does not operate, try a warm boot, then a cold boot. See Resetting the Mobile Computer on page 2-49 .
	Mobile computer removed from cradle while battery was charging.	Insert mobile computer in cradle and begin charging. The lithium-ion battery requires less than four hours to recharge fully.
Cannot see characters on display.	Mobile computer not powered on.	Press the Power button.
During data communication, no data was transmitted, or transmitted data was incomplete.	Mobile computer removed from cradle or unplugged from host computer during communication.	Replace the mobile computer in the cradle, or reattach the Synchronization cable and re-transmit.
	Incorrect cable configuration.	See the System Administrator.
	Communication software was incorrectly installed or configured.	Perform setup. Refer to the <i>MC909X Integrator Guide</i> for details. Ensure that Microsoft ActiveSync 4.1 or greater is installed on the host computer.
No sound is audible.	Volume setting is low or turned off.	Adjust volume.

Table 7-1 *Troubleshooting the Mobile Computer (Continued)*

Problem	Cause	Solution
Mobile computer turns itself off.	Mobile computer is inactive.	<p>The mobile computer turns off after a period of inactivity. If the mobile computer is running on battery power, this period can be set to 30 sec., 1, 2, 3, 4, 5 or 6 minutes. If the mobile computer is running on external power, this period can be set to 1, 2, 3, 5, 10, 15 and 30 minutes.</p> <p>For Windows Mobile 5.0 devices, Check the power settings by tapping Start > Settings > System tab > Power icon > Advanced tab.</p> <p>For Windows CE 5.0 devices, Check the power settings by tapping Start > Settings > Control Panel > Power icon > Power Off tab.</p> <p>Change the setting if you need a longer delay before the automatic shutoff feature activates.</p>
	Battery is depleted.	Replace the battery.
	Battery is not inserted properly.	Insert the battery properly (see Installing and Removing the Main Battery on page 1-6).
Tapping the window buttons or icons does not activate the corresponding feature.	LCD screen not aligned correctly.	Re-calibrate the screen.
	The system is hung.	Warm boot the system. To perform a warm boot (see Resetting the Mobile Computer on page 2-49).
A message appears stating that the mobile computer memory is full.	Too many files stored on the mobile computer.	Delete unused memos and records. You can save these records on the host computer.
	Too many applications installed on the mobile computer.	<p>If you have installed additional applications on the mobile computer, remove them to recover memory.</p> <p>For Windows Mobile 5.0 devices, tap Start > Settings > System tab > Remove Programs icon.</p> <p>For Windows CE 5.0 devices, tap Start > Settings > Control Panel > Remove Programs icon.</p> <p>Select the unused program and tap Remove.</p>

Table 7-1 *Troubleshooting the Mobile Computer (Continued)*

Problem	Cause	Solution
The mobile computer does not accept scan input.	Scanning application is not loaded.	Verify that the unit is loaded with a scanning application. See the System Administrator.
	Unreadable bar code.	Ensure the symbol is not defaced.
	Distance between exit window and bar code is incorrect.	Ensure mobile computer is within proper scanning range.
	Mobile computer is not programmed for the bar code.	Ensure the mobile computer is programmed to accept the type of bar code being scanned.
	Mobile computer is not programmed to generate a beep.	If a beep on a good decode is expected and a beep is not heard, check that the application is set to generate a beep on good decode.
	Battery is low.	If the scanner stops emitting a laser beam when the trigger is pressed, check the battery level. When the battery is low, the scanner shuts off before the mobile computer low battery condition notification. Note: If the scanner is still not reading symbols, contact the distributor or Zebra.
WLAN or WWAN connection is lost when the mobile computer is connected to a host computer using ActiveSync.	Microsoft security feature prevents connection to two separate networks.	Disconnect from the WLAN or WWAN network prior to connecting to a host computer using ActiveSync.

Bluetooth Connection

Table 7-2 *Troubleshooting Bluetooth Connection*

Problem	Cause	Solution
Mobile computer cannot find any Bluetooth devices nearby.	Too far from other Bluetooth devices.	Move closer to the other Bluetooth device(s), within a range of 10 meters.
	The Bluetooth device(s) nearby are not turned on.	Turn on the Bluetooth device(s) you wish to find.
	The Bluetooth device(s) are not in discoverable mode.	Set the Bluetooth device(s) to discoverable mode. If needed, refer to the device's user documentation for help.

Table 7-2 *Troubleshooting Bluetooth Connection (Continued)*

Problem	Cause	Solution
Mobile computer keeps powering down to protect memory contents.	The mobile computer's battery is low.	Recharge the battery.
When trying to connect a Bluetooth phone and mobile computer, the phone thinks a different mobile computer (that I previously paired with the phone) is used.	The phone remembers the name and address of the mobile computer it last paired with via the Bluetooth radio.	Manually delete the pairing device and name from the phone. Refer to the phone's user documentation for instructions.
There is a delay during a resume from suspend.	This is the normal behavior.	No solution required.

Four Slot Charge Only Cradle

Table 7-3 *Troubleshooting the Four Slot Charge Only Cradle*

Problem	Cause	Solution
Mobile computer charge indicator LED does not light.	Cradle is not receiving power.	Ensure the power supply is securely connected and receiving power.
	Mobile computer is not seated correctly in the cradle.	Ensure the battery is properly installed in the mobile computer, and re-seat the mobile computer in the cradle.
	The battery is not properly installed in the mobile computer.	
	The battery in the mobile computer is faulty.	Verify that other batteries charge properly. If so, replace the faulty battery.

Note: The Four Slot Charge Only Cradle has no power indication.

Four Slot Ethernet Cradle

Table 7-4 Troubleshooting the Four Slot Ethernet Cradle

Symptom	Cause	Solution
Attempt by the mobile computer to ActiveSync failed.	Mobile computer removed from the cradle while the LED was blinking green.	Wait one minute and reinsert the mobile computer in the cradle. This allows the cradle to attempt another synchronization.
	ActiveSync on the host computer has not yet closed the previous ActiveSync session.	Wait one minute and reinsert the mobile computer in the cradle. This allows the cradle to attempt another synchronization.
	Incorrect cable configuration.	Check your DHCP server and determine which IP address was allocated to the cradle, then check connectivity by pinging the cradle.
	Communications software improperly configured.	Perform setup as described in the <i>MC909X Integrator Guide</i> . Check your DHCP server and determine which IP address was allocated to the mobile computer slot, then check connectivity by pinging the cradle.
	Mobile computer ActiveSync disabled or not configured to accept network connection.	For Windows Mobile 5.0 devices, tap Start > Programs > ActiveSync icon > Menu > Connections . Uncheck the Synchronize all PCs using this connection: check box. For Windows CE 5.0 devices, tap Start > Settings > Control Panel > PC Connections icon . Uncheck the Enable direct connections to the desktop computer check box.
	Host ActiveSync disabled or not configured to accept network connection.	On the host computer, check File > Connection Settings > Allow network (Ethernet) Server Connection with this desktop computer .
During communications, no data was transmitted, or transmitted data was incomplete.	Mobile computer removed from cradle during communications.	Replace mobile computer in cradle and retransmit.
	Mobile computer has no active connection.	An icon will be visible in the status bar if a connection is currently active.
	Communication software was incorrectly installed or configured.	Ensure that Microsoft ActiveSync 4.1 or greater is installed on the host computer.

Table 7-4 Troubleshooting the Four Slot Ethernet Cradle (Continued)

Symptom	Cause	Solution
Mobile computer has successfully connected through the cradle, but no data is being transmitted over the connection.	Data is being transferred over the S24 radio link.	Temporarily disable the radio link to force data transmission through the cradle. Tap the wireless LAN icon from the systray. Enter an in-valid value in the <i>ESSID</i> : text box and tap the OK button. Power cycle the mobile computer. Verify that your radio link has been disabled (the wireless LAN icon has a red box with an "!" on it). Once you have completed your data transmission, re-enable your radio link.
All Communication Status LEDs are flashing red.	The unit could not configure itself, or it has lost the lease on its IP address.	Connect the unit to an Ethernet network with a correctly functioning DHCP server.
	Failed automatic cradle configuration via local DHCP service.	Connect a properly configured DHCP server or DHCP relay agent to the subnet, and power cycle the cradle. Check the DHCP server log to verify that the cradle is receiving a response to its DHCP request.
	The Ethernet link may be down.	Ensure the ethernet cable is connected to an active hub.
Communication Status LED does not light up.	Mobile computer has been inserted incorrectly into the cradle.	Remove, wait a minute, and then reinsert the mobile computer, ensuring it fits snugly onto the connector at the bottom of the cradle.
	Cradle is not receiving power.	Ensure the power supply is securely connected and receiving power.

Table 7-4 Troubleshooting the Four Slot Ethernet Cradle (Continued)

Symptom	Cause	Solution
Battery is not recharging.	Mobile computer removed from the cradle too soon.	Replace the mobile computer into the cradle. It can take up to four hours to recharge a completely depleted battery pack if mobile computer is suspended or longer if the mobile computer is on. For Windows Mobile 5.0 devices, view battery status by tapping Start > Settings > System tab > Power icon. For Windows CE 5.0 devices, view battery status by tapping Start > Settings > Control Panel > Power icon.
	Battery is faulty.	Verify that other batteries charge properly. If so, replace the faulty battery.
	Mobile computer is not inserted correctly into the cradle.	Remove the mobile computer and reinsert it correctly. Verify charging is active. For Windows Mobile 5.0 devices, view battery status by tapping Start > Settings > System tab > Power icon. For Windows CE 5.0 devices, view battery status by tapping Start > Settings > Control Panel > Power icon.
Warning Message - “! Unable to obtain a server assigned IP address. Try again later or enter an IP address in Network Settings.”	This message occurs if a suspend/resume cycle is performed and the mobile computer radio is not associated (e.g. due to being out of range)	Tap OK to close the message. The mobile computer will obtain address information and communicate through the Ethernet cradle.

Four Slot Spare Battery Charger

Table 7-5 Troubleshooting The Four Slot Spare Battery Charger

Symptom	Possible Cause	Solution
Batteries not charging.	Battery was removed from the charger or charger was unplugged from AC power too soon.	Ensure MSR is receiving power. Ensure mobile computer is attached correctly. Confirm main battery is charging. If a mobile computer battery is fully depleted, it can take up to four hours to fully recharge a battery (if the mobile computer is off and longer if the mobile computer is operating). For Windows Mobile 5.0 devices, view battery status by tapping Start > Settings > System tab > Power icon. For Windows CE 5.0 devices, view battery status by tapping Start > Settings > Control Panel > Power icon.
	Battery is faulty.	Verify that other batteries charge properly. If so, replace the faulty battery.
	Battery contacts not connected to charger.	Verify that the battery is seated in the battery well correctly with the contacts facing down.

Single Slot Serial/USB Cradle

Table 7-6 Troubleshooting the Single Slot Serial/USB Cradle

Symptom	Possible Cause	Solution
LEDs do not light when mobile computer or spare battery is inserted.	Cradle is not receiving power.	Ensure the power cable is connected securely to both the cradle and to AC power.
	Mobile computer is not seated firmly in the cradle.	Remove and re-insert the mobile computer into the cradle, ensuring it is firmly seated.
	Spare battery is not seated firmly in the cradle.	Remove and re-insert the spare battery into the charging slot, ensuring it is firmly seated.
Mobile computer battery is not charging.	Mobile computer was removed from cradle or cradle was unplugged from AC power too soon.	Ensure cradle is receiving power. Ensure mobile computer is seated correctly. Confirm main battery is charging. If a mobile computer battery is fully depleted, it can take up to four hours to fully recharge a battery (if the mobile computer is off and longer if the mobile computer is operating). For Windows Mobile 5.0 devices, view battery status by tapping Start > Settings > System tab > Power icon. For Windows CE 5.0 devices, view battery status by tapping Start > Settings > Control Panel > Power icon.
	Battery is faulty.	Verify that other batteries charge properly. If so, replace the faulty battery.
	The mobile computer is not fully seated in the cradle.	Remove and re-insert the mobile computer into the cradle, ensuring it is firmly seated.
Spare battery is not charging.	Battery not fully seated in charging slot.	Remove and re-insert the spare battery into the cradle, ensuring it is firmly seated.
	Battery inserted incorrectly.	Ensure the contacts are facing down and toward the back of the cradle.
	Battery is faulty.	Verify that other batteries charge properly. If so, replace the faulty battery.
During data communications, no data was transmitted, or transmitted data was incomplete.	Mobile computer removed from cradle during communications.	Replace mobile computer in cradle and retransmit.
	Incorrect cable configuration.	See the System Administrator.
	Communications software is not installed or configured properly.	Perform setup as described in the <i>MC909X Integrator Guide</i> . Ensure that Microsoft ActiveSync 4.1 or greater is installed on the host computer.

Cable Adapter Module

Table 7-7 Troubleshooting The Cable Adapter Module

Symptom	Possible Cause	Solution
Mobile computer battery is not charging.	Mobile computer was removed from CAM or CAM was unplugged from AC power too soon.	Ensure CAM is receiving power. Ensure mobile computer is attached correctly. Confirm main battery is charging. If a mobile computer battery is fully depleted, it can take up to four hours to fully recharge a battery (if the mobile computer is off and longer if the mobile computer is operating). For Windows Mobile 5.0 devices, view battery status by tapping Start > Settings > System tab > Power icon. For Windows CE 5.0 devices, view battery status by tapping Start > Settings > Control Panel > Power icon.
	Battery is faulty.	Verify that other batteries charge properly. If so, replace the faulty battery.
	The mobile computer is not fully attached to the CAM.	Detach and re-attach the CAM to the mobile computer, ensuring it is firmly connected.
During data communications, no data was transmitted, or transmitted data was incomplete.	Mobile computer detached from CAM during communications.	Re-attach mobile computer to CAM and retransmit.
	Incorrect cable configuration.	See the System Administrator.
	Communications software is not installed or configured properly.	Perform setup as described in the <i>MC909X Integrator Guide</i> . Ensure that Microsoft ActiveSync 4.1 or greater is installed on the host computer.

Magnetic Stripe Reader

Table 7-8 Troubleshooting the Magnetic Stripe Reader

Symptom	Possible Cause	Solution
MSR cannot read card.	Mobile computer detached from MSR during card swipe.	Re-attach mobile computer to MSR and reswipe the card.
	Faulty magnetic stripe on card.	See the System Administrator.
	MSR application is not installed or configured properly.	Ensure the MSR application is installed on the mobile computer. Ensure the MSR application is configured correctly.

Table 7-8 *Troubleshooting the Magnetic Stripe Reader (Continued)*

Symptom	Possible Cause	Solution
Mobile computer battery is not charging.	Mobile computer was removed from MSR or MSR was unplugged from AC power too soon.	Ensure MSR is receiving power. Ensure mobile computer is attached correctly. Confirm main battery is charging. If a mobile computer battery is fully depleted, it can take up to four hours to fully recharge a battery (if the mobile computer is off and longer if the mobile computer is operating). For Windows Mobile 5.0 devices, view battery status by tapping Start > Settings > System tab > Power icon . For Windows CE 5.0 devices, view battery status by tapping Start > Settings > Control Panel > Power icon .
	Battery is faulty.	Verify that other batteries charge properly. If so, replace the faulty battery.
	The mobile computer is not fully attached to the MSR.	Detach and re-attach the MSR to the mobile computer, ensuring it is firmly connected.
During data communications, no data was transmitted, or transmitted data was incomplete.	Mobile computer detached from MSR during communications.	Reattach mobile computer to MSR and retransmit.
	Incorrect cable configuration.	See the System Administrator.
	Communications software is not installed or configured properly.	Perform setup as described in the <i>MC909X Integrator Guide</i> .

Modem Module

Table 7-9 *Troubleshooting the Modem Module*

Symptom	Possible Cause	Solution
Mobile computer is not communicating through the modem.	The modem cable is not fully connected.	Connect the modem cable securely to both the modem and the telephone jack.
	Modem is not securely connected to the mobile computer.	Reconnect the modem firmly to the mobile computer.
	Communication software is not installed or configured properly.	Set up the communication software as described in the <i>MC909X Integrator Guide</i> .
	Problem in the telephone lines.	Connect a conventional telephone and dial the remote modem to verify the telephone lines are functioning. If the remote modem does not answer the call and emit answering tones, contact the remote System Administrator.
	Mobile computer's battery is low or discharged, which shuts off power to the modem.	Install a charged battery in the MC909X, or use an external DC power adapter to recharge the battery.
ActiveSync fails.	A partnership was not established with the host computer.	Establish a partnership with the host computer (refer to the <i>MC909X Integrator Guide</i>).
	Host computer is not selected in the <i>ActiveSync</i> window on the mobile computer.	Select a host computer in the <i>ActiveSync</i> window, and perform setup (refer to the <i>MC909X Integrator Guide</i>).
	Mobile computer or modem was disconnected from the telephone line while <i>ActiveSync</i> was in progress.	Disconnect the modem cable for 30 seconds to hang up the local telephone connection. Close any open windows on the mobile computer and any modem connections.

Table 7-9 *Troubleshooting the Modem Module (Continued)*

Symptom	Possible Cause	Solution
Dial-out fails	Location setting is incorrect.	Verify Dialing Locations. Verify Dialing Patterns are correct for the current location. For example, enter 'G' in the <i>For local calls, dial:</i> field to dial directly, or '9,G' if the telephone system requires dialing '9' first to access an outside line.
	Incorrect server phone number.	Verify the connection phone number in the <i>Connecting</i> window.
	Pulse dialing not supported for country.	Use a connection within a tone-dialing system.
	Dialtone detection not supported.	The service you subscribe to (e.g., a remote answering service) may use a different type of dialtone. Disable dialtone detection on the modem by entering the initialization string "ATXO" in the <i>Extra dial-string modem commands:</i> text box of the <i>Modem Settings</i> window.
	The Connection Manager routes are incorrect.	Warm boot the mobile computer and confirm the connection settings.

Appendix A Specifications

Technical Specifications

The following tables summarize the mobile computer's intended operating environment and general technical hardware specifications.

Mobile Computer

The following table summarizes the mobile computer's intended operating environment.

Table A-1 *Technical Specifications*

Item	MC909X-G	MC909X-K	MC909X-S
Physical and Environmental Characteristics			
Dimensions (Non-WWAN)	9.1 in. L x 3.6 in. W x 7.6 in. H 23.1 cm L x 9.1 cm H x 19.3 cm H	9.1 in L x 3.6 in. W x 2.2 in. H 23.1 cm L x 9.1 cm H x 5.6 cm H	7.9 in L x 3.6 in. W x 2.2 in. H 20.1 cm L x 9.1 cm H x 5.6 cm H
Dimensions (WWAN)		9.1 in L x 3.6 in. W x 2.3 in. H 23.1 cm L x 9.1 cm H x 5.8 cm H	7.9 in L x 3.6 in. W x 2.3 in. H 20.1 cm L x 9.1 cm H x 5.8 cm H
Weight	25 oz. (includes battery, scanner and radio)	22-25 oz., configuration-dependent	20-23 oz., configuration-dependent
Keyboard	28-key; 43-key; 53-key Terminal Emulation (5250, 3270, VT)	28-key; 33-key; 43-key; 53-key	28-key; 38-key alpha-prime; 38-key numeric-prime
Display	3.8 in. 1/4 VGA Monochrome or Color: Win CE (WM Color only)	3.8 in. 1/4 VGA Color	3.8 in. 1/4 VGA Color
Power	Removable, rechargeable 7.2 V Lithium Ion 2200 mAh battery pack, 15.8 watt hours	Removable, rechargeable 7.4 V Lithium Ion 2200 mAh battery pack, 15.8 watt hours	Removable, rechargeable 7.2 V Lithium ion 1550 mAh battery pack, 11.1 watt hours

Table A-1 Technical Specifications (Continued)

Item	MC909X-G	MC909X-K	MC909X-S
Performance Characteristics			
CPU	XScale Bulverde PXA270 processor at 624MHz		
Operating System	Microsoft Windows CE 5.0 or Windows Mobile 5.0 Premium Edition	Microsoft Windows Mobile 5.0 Premium and Phone Editions	
Memory (RAM/ROM)	Windows CE: 64MB/64MB Windows Mobile: 64MB/128MB	Windows Mobile: 64MB/128MB	
Expansion	SD/MMC Card		
Application Development	PSDK, DCP and SMDK available through Zebra Developer Zone Web Site	SMDK available through Zebra Developer Zone Web Site	
Data Capture Options	1D Standard Range scan engine 1D Long Range scan engine Omni-directional 1D and 2D imaging engine reads symbologies and captures grayscale images and signatures with intuitive laser aiming.	1D Standard Range scan engine Omni-directional 1D and 2D imaging engine reads symbologies and captures grayscale images and signatures with intuitive laser aiming.	
User Environment			
Operating Temperature	-4°F to 122°F (-20°C to 50°C)		
Storage Temperature	-25°F to 160°F (-40°C to 70°C)		
Battery Charging Temperature	32 °F to 104 °F (0 °C to +40 °C) ambient temperature range.		
Humidity	5% to 95% non condensing		
Drop Specification	Multiple 6 ft.(1.8m) drops to concrete across operating temperature range		
Tumble	2,000 one-meter tumbles at room temperature (4,000 hits)		
Environmental Sealing	IP64 (electronic enclosure)		
ESD	+/-15kVdc air discharge +/-8kVdc direct discharge +/-8kVdc indirect discharge		

Table A-1 *Technical Specifications (Continued)*

Item	MC909X-G	MC909X-K	MC909X-S
WLAN Wireless Data Communications			
WLAN radio	Zebra 802.11a/b/g		
Operating Channels	Channel 8 - 169 (5040 - 5845 MHz) (4920 - 4980 MHz) Japan only Channel 1 - 13 (2412 - 2472 MHz) Channel 14 (2484 MHz) Japan only Actual operating frequencies depend on regulatory rules and certification agency		
Security	WEP (40 or 128 bit), TKIP, TLS, TTLS (MS-CHAP), TTLS (MS-CHAP v2), TTLS (CHAP), TTLS-MD5, TTLS-PAP, PEAP-TLS, PEAP (MS-CHAP v2), AES, LEAP, WPA2		
Voice Communication (Windows Mobile 5.0 devices only)	Integrated Voice-over-IP ready (P2P, PBX, PPT), Wi-Fi -certified, IEEE 802.11a/b/g direct sequence wireless LAN		
Output Power	100mW U.S. and International		
Data Rate	802.11a: 54Mb per second 802.11b: 11Mb per second 802.11g: 54Mb per second		
Frequency Range	802.11a: 5 GHz; country-dependent 802.11b: 2.4 GHz; country-dependent 802.11g: 2.4 GHz; country-dependent		
Antenna	Internal		
WPAN Wireless Data Communications			
Bluetooth	Bluetooth Version 1.2 with BTE Explorer (manager) included		

Table A-1 Technical Specifications (Continued)

Item	MC909X-G	MC909X-K	MC909X-S
Wireless WAN (WWAN) Data Communications			
EDGE/GPRS Radio Module	N/A	<p>General features:</p> <ul style="list-style-type: none"> • Quad-Band GSM 850/900/1800/1900 MHz • EDGE Multislot class 10 • GPRS Multislot class 12 • GSM release 99 • Output power: <ul style="list-style-type: none"> • class 4 (2 W) for GSM850 • class 4 (2 W) for EGSM900 • class 1 (1 W) for GSM1800 • class 1 (1 W) for GSM1900 <p>Specification for fax:</p> <ul style="list-style-type: none"> • Group 3, class 1 <p>Specifications for data EDGE (E-GPRS):</p> <ul style="list-style-type: none"> • Multislot class 10 • Modulation and coding scheme MCS 1– 9 • Mobile station class B <p>Specifications for data (GPRS):</p> <ul style="list-style-type: none"> • Multislot class 12 • Full PBCCH support • Mobile station class B • Coding scheme 1– 4 <p>Specifications for SMS:</p> <ul style="list-style-type: none"> • Via GSM or GPRS • Point-to-point MO and MT • Text and PDU mode • SMS cell broadcast <p>Specifications for voice:</p> <ul style="list-style-type: none"> • Half rate (HR) • Full rate (FR) • Enhanced full rate (EFR) • Adaptive multi rate (AMR) 	
iDEN Radio Module	N/A	<p>Frequency Range:</p> <ul style="list-style-type: none"> • 800 - 900 MHz <p>Antenna:</p> <ul style="list-style-type: none"> • internal <p>GPS-Enabled:</p> <ul style="list-style-type: none"> • 12 channel assisted GPS (aGPS) 	

Table A-1 *Technical Specifications (Continued)*

Item	MC909X-G	MC909X-K	MC909X-S
Peripherals and Accessories			
Cradles	Single-slot and 4-slot cradles available		
Printers	Supports extensive line of Zebra approved printers, cables and accessories		
Charger	4-Slot universal battery charger		
Other Accessories	Cable Adapter Module; Magnetic Stripe Reader; Modem; Full set of holsters In accordance with the SymbolPlus partner program		
Regulatory			
Electrical Safety	Certified to UL60950-1, CSA C22.2 No. 60950-1, EN60950-1, IEC 60950-1		
RF & EMC	FCC Part 2 (SAR), FCC Part 15, RSS210; EN 300 328 & EN 301 487, EN55022, EN55024	MC9090: FCC Part 2 (SAR), FCC Part 15, RSS210 B, EN 300 328, 301 489-1, 489-17 MC9094: FCC Part 2 (SAR), FCC Part 22, FCC Part 24, FCC Part 15, RSS210, EN 300 328, EN 301 489-1, 301 489-7, 301 489-17 MC9097: FCC Part 2 (SAR), FCC Part 15, FCC Part 90, RSS210	
Laser Safety	IEC Class2/FDA Class II in accordance with IEC60825-1/EN60825-1		

Table A-2 *Data Capture Options*

Item	Description		
Laser Decode Capability	Code 39 Codabar Interleaved 2 of 5 MSI UPC/EAN supplementals Webcode RSS Expanded	Code 128 Code 11 EAN-8 UPCA Coupon Code RSS-14	Code 93 Discrete 2 of 5 EAN-13 UPCE Trioptic 39 RSS Limited
MC909X with Windows Mobile 5.0 and OEM Version 01.39.0001 and MC909X with Windows CE 5.0 and OEM Version 01.26.0001 and higher: Chinese 2 of 5			
Imaging Decode Capability	Code 39 Codabar Discrete 2 of 5 EAN-13 UPC/EAN supplementals Webcode Composite C Macro PDF-417 RSS Expanded Data Matrix US Planet Canadian 4-state	Code 128 Code 11 MSI UPCA Coupon Code TLC39 Micro PDF-417 (Macro) Micro PDF-417 RSS Limited Maxi Code UK 4-state Japanese 4-state	Code 93 Interleaved 2 of 5 EAN-8 UPCE Trioptic 39 Composite AB PDF-417 QR Code RSS-14 US Postnet Australian 4-state Dutch Kix
MC909X with Windows Mobile 5.0 and OEM Version 01.39.0001 and MC909X with Windows CE 5.0 and OEM Version 01.26.0001 and higher: Chinese 2 of 5 USPS 4-state (US4CB) Aztec microQR			

Modem Module

Table A-3 *Environmental Parameters and Technical Hardware Specifications*

Item	Description
Asynchronous character format	Up to 10 bits, including data, start, stop, and parity bits
Asynchronous data rates	Transmission rate fallback through 300 bps
Chipset	Conexant SCM
Compatible public switched network jacks	RJ11
Dialing capability	Tone and rotary pulse

Table A-3 *Environmental Parameters and Technical Hardware Specifications (Continued)*

Item	Description
Line requirements	Public switched telephone network (PSTN) including international connections
Operating environment	Altitude: up to 20,000 ft. Humidity: 10% to 90% non-condensing
Operating temperature	Operating: 32° to 122°F / 0° to 50°C Storage: -4° to 149°F / -20° to 65°C
Operating modes	Asynchronous, full duplex, automatic and manual call originate
Performance	Line speed up to 33,600 bps HHC to modem speed (DTE speed) up to 57,600 bps V.42bis data compression V.42 LAPM error correction
Current consumption	100 mA active <10 mA sleep
Pulse dialing rate (except where prohibited under TBR-21 rules)	10 pulses per second Pulse dialing duty cycle: 39/61% (US) make-to-break ratio
Ringer equivalence	0.1 dBm
Standards & protocols	Bell 103, Bell 212A, Hayes AT command set, and ITU Vs. 17, 21, 22 A & B, 22bis, 23, 25bis, 27 ter, 29, 32, 32bis, 42bis
Tone detected	Dial, busy, ring back, modem answer tones. Blind dialing based on time-out periods available for incompatible tones.
AC Adapter	9V, 2 amp regulated AC/DC adapter allows unlimited modem use. Do NOT substitute an AC adapter; using an incorrect AC power supply causes electrical damage to the mobile computer and voids warranty.

Mobile Computer Pin-Outs

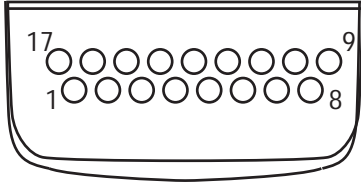

Figure A-1 Pin Locations

Table A-4 Pin-Outs

PIN Number	Signal Name	Function
1	USB_GND	USB
2	USB_D_PLUS	USB
3	TXD	RS232C
4	RXD	RS232C
5	DCD	RS232C
6	RTS	RS232C
7	DSR	RS232C
8	GND	Ground, 2.5A max.
9	RI	RS232C
10	CRADLE_DET	Grounded by cradle when in cradle
11	DTR	RS232C
12	Not connected	Not connected
13	POWER_IN	12V, 2.5A max
14	CTS	RS232C
15	USB_5V_DET	USB
16	USB_D_MINUS	USB
17	EXT_PWR_OUT	3.3V @500mA

Accessory CAM and MSR Pin-Outs

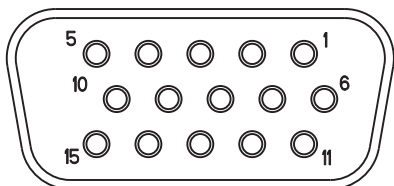

Figure A-2 CAM and MSR Serial Connector

Table A-5 CAM and MSR Serial Connector Pin-outs

Pin	Signal
1	USB_5V_DET
2	USB_D_MINUS
3	USB_D_PLUS
4	GND
5	GND
6	PWR_EXT_OUT
7	CRADLE_DET*
8	DSR
9	DCD
10	TXD
11	CTS
12	DTR
13	RI
14	RTS
15	RXD

Non-Incendive Devices

Hazardous (Classified) Location Class I, Division 2, Groups A, B, C & D

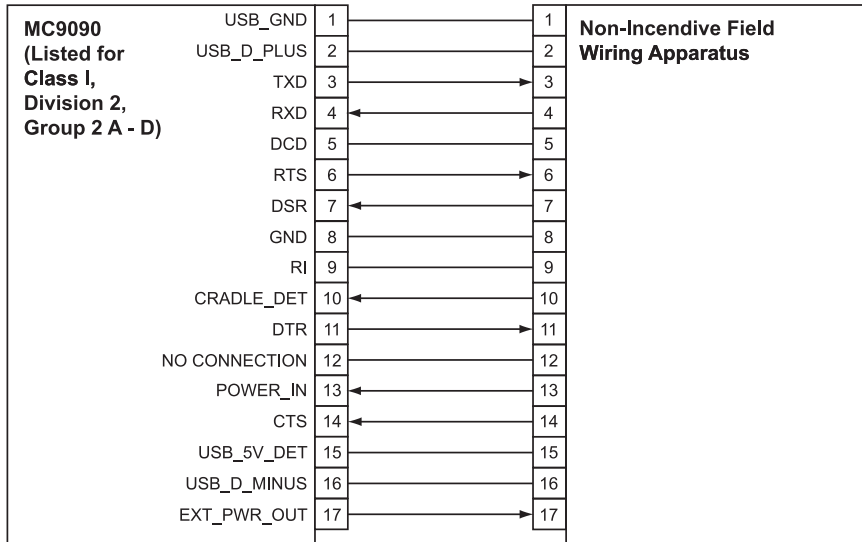

Pin 17 to Pin 8

$V_{max} = 3.37 \text{ VDC}$
 $I_{max} = 850 \text{ mA}$
 $C_i = 100 \mu\text{F}$
 $L_i = 0.35 \mu\text{H}$

Pins 3, 6, or 10 to Pin 8

$V_{max} = 5.6 \text{ VDC}$
 $I_{max} = 31 \text{ mA}$
 $C_i = 200 \mu\text{F}$
 $L_i = 100 \mu\text{H}$

Pin 17 to Pin 8

$V_{oc} = 3.37 \text{ VDC}$
 $I_{sc} = 850 \text{ mA}$
 $C_a = 73 \mu\text{F}$
 $L_a = 12 \mu\text{H}$

Pins 3, 6, or 10 to Pin 8

$V_{oc} = 5.6 \text{ VDC}$
 $I_{sc} = 31 \text{ mA}$
 $C_a = 200 \mu\text{F}$
 $L_i = 100 \mu\text{H}$

Selected associated non-incendive field wiring apparatus shall satisfy the following:

Non-Incendive Field Wiring Apparatus		MC9090
V_{oc}	\leq	V_{max}
I_{sc}	\leq	I_{max}
C_a	\geq	C_i
L_a	\geq	L_i
V_{max}	\geq	V_{oc}
I_{max}	\geq	I_{sc}
C_i	\leq	C_a
L_i	\leq	L_a

Appendix B Keypad Special Keys

Introduction

This appendix contains the keypad functions/special characters for the keypads. Each function/special character is included in the table along with how the function/special character is generated.

Keypads

The mobile computer is available with one of the following keypads:

- 28-key keypad
- 33-key keypad
- 38-key keypad
- 43-key keypad
- 53-key keypad.

The keypads can be selected as necessary to support specialized applications. The keypads contain a **Power** button, application keys, scroll keys and function keys. The keypad is color-coded to indicate the alternate function key (blue) values and the alternate ALPHA key (orange) values. See [Table B-1](#) for the special character generation. Characters can also be generated using the keyboard input panel.

Table B-1 *Special Character Generation Map*

Special Character	28-Key Keypad	33-Key Keypad	38-Key Numeric Keypad	38-Key Alpha Keypad	43-Key Keypad	53-Key Keypad
[(open square bracket)						Blue Key - E
] (close square bracket)						Blue Key - F
/ (forward slash)	Blue Key - 9	Blue Key - 1	Blue Key - L	Orange Key - P	Blue Key - F12	Blue Key - L , Blue Key - V

Table B-1 Special Character Generation Map (Continued)

Special Character	28-Key Keypad	33-Key Keypad	38-Key Numeric Keypad	38-Key Alpha Keypad	43-Key Keypad	53-Key Keypad
\ (Backslash)						Blue Key - G
= (equal sign)	Blue Key - 5	Blue Key - 2	Blue Key - F7	Orange Key - T	Blue Key - BKSP	Blue Key - W
; (semi-colon)						Blue Key - R
' (apostrophe)						Blue Key - J
, (comma)						Blue Key - A
. (period)				Orange Key - M		Blue Key - B
! (exclamation point)						SHIFT - 1
@ (at sign)						SHIFT - 2
# (Pound sign)		Blue Key - 3		Orange Key - O		SHIFT - 3
\$ (dollar sign)						SHIFT - 4
% (percent sign)						SHIFT - 5
^ (carat)						SHIFT - 6
& (ampersand)						SHIFT - 7
* (asterisk)	Blue Key - . , SHIFT - Blue Key - .	Blue Key - .	Blue Key - K , SHIFT - Blue Key - K	Orange Key - L		Blue Key - U , SHIFT - Blue Key - U , SHIFT - 8
((open parenthesis)						SHIFT - 9
) (close parenthesis)		SHIFT - 0				SHIFT - 0
' (single quote)						Blue Key - C

Table B-1 Special Character Generation Map (Continued)

Special Character	28-Key Keypad	33-Key Keypad	38-Key Numeric Keypad	38-Key Alpha Keypad	43-Key Keypad	53-Key Keypad
" (double quote)						SHIFT - Blue Key - C
+ (plus sign)	SHIFT - Blue Key - 5 , Blue Key - 7 , SHIFT - Blue Key - 7	Blue Key - - , SHIFT - Blue Key - 2	Blue Key - SHIFT - F7 , Blue Key - SPACE , Blue Key - SHIFT - SPACE	Orange Key - D	Blue Key - F9 , Blue Key - SHIFT - F9 , Blue Key - SHIFT - BKSP	Blue Key - S , SHIFT - Blue Key - S , SHIFT - Blue Key - W
- (dash)	Blue Key - 8		Blue Key - J	Orange Key - H	Blue Key - F10 , Blue Key - SHIFT - F10	Blue Key - N , Blue Key - T , SHIFT - Blue Key - T
: (colon)						SHIFT - Blue Key - R
< (less than sign)						SHIFT - Blue Key - A
> (greater than sign)						SHIFT - Blue Key - B
? (question mark)	SHIFT - Blue Key - 9	SHIFT - Blue Key - 1	SHIFT - Blue Key - L		Blue Key - SHIFT - F12	SHIFT - Blue Key - L , SHIFT - Blue Key - V
_ (underscore)	SHIFT - Blue Key - 8		SHIFT - Blue Key - J			SHIFT - Blue Key - N
{ (open curly bracket)						SHIFT - Blue Key - E
} (close curly bracket)						SHIFT - Blue Key - F
~ (tilde)						SHIFT - Blue Key - J
 (pipe)						SHIFT - Blue Key - G
Tab	Blue Key - Space			Blue Key - u	Blue Key - Space	Blue Key - Space

Appendix C Regulatory

Introduction

This appendix contains the accessory power supply regulatory compliance statements.

Accessory Power Supply Regulatory Compliance

Table C-1 *Accessory Power Supplies, Regulatory Compliance Statements*

Accessory	Power Supplies Regulatory Compliance Statements
Single Slot Serial/USB Cradle Power Supply Magnetic Stripe Reader (MSR) Cable Adapter Module (CAM)	<p>Use only an approved power supply output rated 12 VDC and minimum 3.3 A. The power supply is certified to EN60950 with SELV outputs. Use of alternative power supply will invalidate any approval given to this device and may be dangerous.</p> <p>Benutzen Sie nur eine von genehmigte Stromversorgung mit einer Ausgangsleistung von 12 V (Gleichstrom) und mindestens 3.3 A. Die Stromversorgung ist nach EN60950 für die Verwendung in SELV-Stromkreisen zertifiziert. Bei Verwendung eines anderen Netzteils werden alle für das Gerät gewährten Genehmigungen außer Kraft gesetzt, und der Betrieb kann gefährlich sein.</p>
Four Slot Charge Only Cradle Power Supply Four Slot Ethernet Cradle Power Supply	<p>Use only an approved power supply output rated 12 VDC and minimum 9 A. The power supply is certified to EN60950 with SELV outputs. Use of alternative power supply will invalidate any approval given to this device and may be dangerous.</p> <p>Benutzen Sie nur eine von genehmigte Stromversorgung mit einer Ausgangsleistung von 12 V (Gleichstrom) und mindestens 9 A. Die Stromversorgung ist nach EN60950 für die Verwendung in SELV-Stromkreisen zertifiziert. Bei Verwendung eines anderen Netzteils werden alle für das Gerät gewährten Genehmigungen außer Kraft gesetzt, und der Betrieb kann gefährlich sein.</p>

Table C-1 *Accessory Power Supplies, Regulatory Compliance Statements*

Accessory	Power Supplies Regulatory Compliance Statements
Universal Battery Charger (UBC) Adapter Power Supply	<p data-bbox="621 369 1515 495">Use only an approved power supply output rated 15 VDC and minimum 1.5 A. The power supply is certified to EN60950 with SELV outputs. Use of alternative power supply will invalidate any approval given to this device and may be dangerous.</p> <p data-bbox="621 537 1515 726">Benutzen Sie nur eine von genehmigte Stromversorgung mit einer Ausgangsleistung von 15 V (Gleichstrom) und mindestens 1.5 A. Die Stromversorgung ist nach EN60950 für die Verwendung in SELV-Stromkreisen zertifiziert. Bei Verwendung eines anderen Netzteils werden alle für das Gerät gewährten Genehmigungen außer Kraft gesetzt, und der Betrieb kann gefährlich sein.</p>
Four Slot Spare Battery Charger Power Supply	<p data-bbox="621 753 1515 879">Use only an approved power supply output rated 15 VDC and minimum 5 A. The power supply is certified to EN60950 with SELV outputs. Use of alternative power supply will invalidate any approval given to this device and may be dangerous.</p> <p data-bbox="621 921 1515 1110">Benutzen Sie nur eine von genehmigte Stromversorgung mit einer Ausgangsleistung von 15 V (Gleichstrom) und mindestens 5 A. Die Stromversorgung ist nach EN60950 für die Verwendung in SELV-Stromkreisen zertifiziert. Bei Verwendung eines anderen Netzteils werden alle für das Gerät gewährten Genehmigungen außer Kraft gesetzt, und der Betrieb kann gefährlich sein.</p>

Glossary

Numeric

802.11. A group of wireless specifications developed by the Institute of Electrical and Electronics Engineers (IEEE). It specifies an over-the-air interface between a wireless client and a base station or between two wireless clients.

802.11a. Operates in the 5 GHz frequency range (5.125 to 5.85 GHz) with a maximum 54Mbit/sec. signaling rate. The 5 GHz frequency band is not as crowded as the 2.4 GHz frequency because it offers significantly more radio channels than the 802.11b and is used by fewer applications. It has a shorter range than 802.11g and is not compatible with 802.11b.

802.11b. Operates in the 2.4 GHz Industrial, Scientific and Measurement (ISM) band (2.4 to 2.4835 GHz) and provides signaling rates of up to 11Mbit/sec. This is a very commonly used frequency. Microwave ovens, cordless phones, medical and scientific equipment, as well as Bluetooth devices, all work within the 2.4 GHz ISM band.

802.11g. Similar to 802.11b, but this standard supports signaling rates of up to 54Mbit/sec. It also operates in the heavily used 2.4 GHz ISM band but uses a different radio technology to boost overall throughput. Compatible with the 802.11b.

A

Access Point. Provides a bridge between Ethernet wired LANs and the wireless network. Access points are the connectivity point between Ethernet wired networks and devices (laptops, hand-held computers, point-of-sale terminals) equipped with a wireless LAN adapter card.

Ad Hoc Mode. A wireless network framework in which devices communicate directly with one another without using an access point.

API. An interface by means of which one software component communicates with or controls another. Usually used to refer to services provided by one software component to another, usually via software interrupts or function calls

Application Programming Interface. See **API**.

ANSI Terminal. A display terminal that follows commands in the ANSI standard terminal language. For example, it uses escape sequences to control the cursor, clear the screen and set colors. Communications programs support the ANSI terminal mode and often default to this terminal emulation for dial-up connections to online services.

ASCII. American Standard Code for Information Interchange. A 7 bit-plus-parity code representing 128 letters, numerals, punctuation marks and control characters. It is a standard data transmission code in the U.S.

Association. The process of determining the viability of the wireless connection and establishing a wireless network's root and designated access points. A mobile computer associates with its wireless network as soon as it is powered on or moves into range.

Autodiscrimination. The ability of an interface controller to determine the code type of a scanned bar code. After this determination is made, the information content is decoded.

B

Bar. The dark element in a printed bar code symbol.

Bar Code. A pattern of variable-width bars and spaces which represents numeric or alphanumeric data in machine-readable form. The general format of a bar code symbol consists of a leading margin, start character, data or message character, check character (if any), stop character, and trailing margin. Within this framework, each recognizable symbology uses its own unique format. See **Symbology**.

Bar Code Density. The number of characters represented per unit of measurement (e.g., characters per inch).

Bar Height. The dimension of a bar measured perpendicular to the bar width.

Bar Width. Thickness of a bar measured from the edge closest to the symbol start character to the trailing edge of the same bar.

Bit. Binary digit. One bit is the basic unit of binary information. Generally, eight consecutive bits compose one byte of data. The pattern of 0 and 1 values within the byte determines its meaning.

Bits per Second (bps). Bits transmitted or received.

Bluetooth. A low-cost, short-range radio link between two devices. Bluetooth can replace cables and can be used to create ad hoc networks and provide a standard way to connect devices.

Bit. Binary digit. One bit is the basic unit of binary information. Generally, eight consecutive bits compose one byte of data. The pattern of 0 and 1 values within the byte determines its meaning.

bps. See **Bits Per Second**.

Byte. On an addressable boundary, eight adjacent binary digits (0 and 1) combined in a pattern to represent a specific character or numeric value. Bits are numbered from the right, 0 through 7, with bit 0 the low-order bit. One byte in memory is used to store one ASCII character.

BOOTP. A protocol for remote booting of diskless devices. Assigns an IP address to a machine and may specify a boot file. The client sends a bootp request as a broadcast to the bootp server port (67) and the bootp server responds using the bootp client port (68). The bootp server must have a table of all devices, associated MAC addresses and IP addresses.

boot or boot-up. The process a computer goes through when it starts. During boot-up, the computer can run self-diagnostic tests and configure hardware and software.

C

CAM. (Continuously Aware Mode) Mode in which the adapter is instructed to continually check for network activity.

CDMA. (Code Division Multiple Access) A digital cellular technology that uses spread spectrum techniques that separates them through the use of digital frequency codes across the full available spectrum.

CDRH. (Center for Devices and Radiological Health) A federal agency responsible for regulating laser product safety. This agency specifies various laser operation classes based on power output during operation.

CDRH Class 1. This is the lowest power CDRH laser classification. This class is considered intrinsically safe, even if all laser output were directed into the eye's pupil. There are no special operating procedures for this class.

CDRH Class 2. No additional software mechanisms are needed to conform to this limit. Laser operation in this class poses no danger for unintentional direct human exposure.

CHAP. (Challenge Handshake Authentication Protocol) A type of authentication in which the authentication agent (typically a network server) sends the client program a random value that is used only once and an ID value. Both the sender and peer share a predefined secret. The peer concatenates the random value (or nonce), the ID and the secret and calculates a one-way hash using MD5. The hash value is sent to the authenticator, which in turn builds that same string on its side, calculates the MD5 sum itself and compares the result with the value received from the peer. If the values match, the peer is authenticated.

Character. A pattern of bars and spaces which either directly represents data or indicates a control function, such as a number, letter, punctuation mark, or communications control contained in a message.

Character Set. Those characters available for encoding in a particular bar code symbology.

Check Digit. A digit used to verify a correct symbol decode. The scanner inserts the decoded data into an arithmetic formula and checks that the resulting number matches the encoded check digit. Check digits are required for UPC but are optional for other symbologies. Using check digits decreases the chance of substitution errors when a symbol is decoded.

Codabar. A discrete self-checking code with a character set consisting of digits 0 to 9 and six additional characters: (-\$/,+).

Code 128. A high density symbology which allows the controller to encode all 128 ASCII characters without adding extra symbol elements.

Code 3 of 9 (Code 39). A versatile and widely used alphanumeric bar code symbology with a set of 43 character types, including all uppercase letters, numerals from 0 to 9 and 7 special characters (space, minus (-), plus (+), period (.), dollar sign (\$), slash (/), and percent (%)). The code name is derived from the fact that 3 of 9 elements representing a character are wide, while the remaining 6 are narrow.

Code 93. An industrial symbology compatible with Code 39 but offering a full character ASCII set and a higher coding density than Code 39.

Code Length. Number of data characters in a bar code between the start and stop characters, not including those characters.

Cold Boot. A cold boot restarts the mobile computer and erases all user stored records and entries.

COM port. Communication port; ports are identified by number, e.g., COM1, COM2.

Continuous Code. A bar code or symbol in which all spaces within the symbol are parts of characters. There are no intercharacter gaps in a continuous code. The absence of gaps allows for greater information density.

Cradle. A cradle is used for charging the terminal battery and for communicating with a host computer, and provides a storage place for the terminal when not in use.

D

Data Communications Equipment (DCE). A device (such as a modem) which is designed to attach directly to a DTE (Data Terminal Equipment) device.

DCE. See **Data Communications Equipment**.

DCP. See **Device Configuration Package**.

Dead Zone. An area within a scanner's field of view, in which specular reflection may prevent a successful decode.

Decode. To recognize a bar code symbology (e.g., UPC/EAN) and then analyze the content of the specific bar code scanned.

Decode Algorithm. A decoding scheme that converts pulse widths into data representation of the letters or numbers encoded within a bar code symbol.

Decryption. Decryption is the decoding and unscrambling of received encrypted data. Also see, **Encryption** and **Key**.

Depth of Field. The range between minimum and maximum distances at which a scanner can read a symbol with a certain minimum element width.

Device Configuration Package. The Device Configuration Package provides flash partitions, Terminal Configuration Manager (TCM) and the associated TCM scripts. With this package hex images that represent flash partitions can be created and downloaded to the mobile computer.

Discrete Code. A bar code or symbol in which the spaces between characters (intercharacter gaps) are not part of the code.

Discrete 2 of 5. A binary bar code symbology representing each character by a group of five bars, two of which are wide. The location of wide bars in the group determines which character is encoded; spaces are insignificant. Only numeric characters (0 to 9) and START/STOP characters may be encoded.

DRAM. Dynamic random access memory.

DTE. See **Data Terminal Equipment**.

E

EAN. (European Article Number) This European/International version of the UPC provides its own coding format and symbology standards. Element dimensions are specified metrically. EAN is used primarily in retail.

EAP. (Extensible Authentication Protocol) A general authentication protocol used to control network access. Many specific authentication methods work within this framework.

EAP-PEAP. (Extensible Authentication Protocol-Protected Extensible Authentication Protocol) A mutual authentication method that uses a combination of digital certificates and another system, such as passwords.

EAP-TLS. (Extensible Authentication Protocol-Transport Layer Security) A mutual authentication method that uses digital certificates.

EDGE. (Enhanced Data rates for GSM Evolution) Allows wireless transmission of data at speeds up to 384K bps. It's based on GSM technology and allows for high-bandwidth services such as multimedia.

Element. Generic term for a bar or space.

Encoded Area. Total linear dimension occupied by all characters of a code pattern, including start/stop characters and data.

Encryption. Encoding data to prevent it from being read by unauthorized people.

ENQ (RS-232). ENQ software handshaking is also supported for the data sent to the host.

Ethernet . An IEEE standard network protocol that specifies how data is placed on and retrieved from a common transmission medium.

ESD. Electro-Static Discharge

F

Flash Disk. An additional megabyte of non-volatile memory for storing application and configuration files.

Flash Memory. Flash memory is nonvolatile, semi-permanent storage that can be electronically erased in the circuit and reprogrammed.

File Transfer Protocol (FTP). A TCP/IP application protocol governing file transfer via network or telephone lines. See **TCP/IP**.

FTP. See **File Transfer Protocol**.

G

GPS. (Global Positioning System) A "constellation" of 24 satellites that orbit the Earth at a height of 10,900 miles, making it possible for people using ground receivers to determine their geographic location within 10 to 100 meters. The satellites

use simple mathematical calculations to broadcast information that is translated as longitude, latitude and altitude by Earth-based receivers.

GPRS. (General Packet Radio Service) A technology that runs at speeds up to 115Kbit/sec., compared with the 9.6Kbit/sec. of older GSM systems. It enables high-speed wireless Internet and other communications such as e-mail, games and applications. It supports a wide range of bandwidths and is an efficient use of limited bandwidth. It's particularly suited for sending and receiving small amounts of data, such as e-mail and Web browsing, as well as large volumes of data.

GSM. (Global System for Mobile Communications) A digital cellular system based on TDMA narrowband technology, which gives users access to time slots on the same frequency bands. It allows up to eight simultaneous communications on the same frequency.

H

Hard Reset. See **Cold Boot.**

Hz. Hertz; A unit of frequency equal to one cycle per second.

Host Computer. A computer that serves other terminals in a network, providing such services as computation, database access, supervisory programs and network control.

I

IDE. Intelligent drive electronics. Refers to the solid-state hard drive type.

IEC. International Electrotechnical Commission. This international agency regulates laser safety by specifying various laser operation classes based on power output during operation.

IEC (825) Class 1. This is the lowest power IEC laser classification. Conformity is ensured through a software restriction of 120 seconds of laser operation within any 1000 second window and an automatic laser shutdown if the scanner's oscillating mirror fails.

IEEE Address. See **MAC Address.**

Interleaved 2 of 5. A binary bar code symbology representing character pairs in groups of five bars and five interleaved spaces. Interleaving provides for greater information density. The location of wide elements (bar/spaces) within each group determines which characters are encoded. This continuous code type uses no intercharacter spaces. Only numeric (0 to 9) and START/STOP characters may be encoded.

IOCTL. Input/Output Control.

Intercharacter Gap. The space between two adjacent bar code characters in a discrete code.

Interleaved Bar Code. A bar code in which characters are paired together, using bars to represent the first character and the intervening spaces to represent the second.

Interleaved 2 of 5. A binary bar code symbology representing character pairs in groups of five bars and five interleaved spaces. Interleaving provides for greater information density. The location of wide elements (bar/spaces) within each

group determines which characters are encoded. This continuous code type uses no intercharacter spaces. Only numeric (0 to 9) and START/STOP characters may be encoded.

Internet Protocol Address. See **IP**.

I/O Ports. interface The connection between two devices, defined by common physical characteristics, signal characteristics, and signal meanings. Types of interfaces include RS-232 and PCMCIA.

Input/Output Ports. I/O ports are primarily dedicated to passing information into or out of the terminal's memory. Series 9000 mobile computers include Serial and USB ports.

IP. (Internet Protocol) The IP part of the TCP/IP communications protocol. IP implements the network layer (layer 3) of the protocol, which contains a network address and is used to route a message to a different network or subnetwork. IP accepts "packets" from the layer 4 transport protocol (TCP or UDP), adds its own header to it and delivers a "datagram" to the layer 2 data link protocol. It may also break the packet into fragments to support the maximum transmission unit (MTU) of the network.

IP Address. (Internet Protocol address) The address of a computer attached to an IP network. Every client and server station must have a unique IP address. A 32-bit address used by a computer on a IP network. Client workstations have either a permanent address or one that is dynamically assigned to them each session. IP addresses are written as four sets of numbers separated by periods; for example, 204.171.64.2.

IPX/SPX. Internet Package Exchange/Sequential Packet Exchange. A communications protocol for Novell. IPX is Novell's Layer 3 protocol, similar to XNS and IP, and used in NetWare networks. SPX is Novell's version of the Xerox SPP protocol.

IS-95. Interim Standard 95. The EIA/TIA standard that governs the operation of CDMA cellular service. Versions include IS-95A and IS-95B. See CDMA.

K

Key. A key is the specific code used by the algorithm to encrypt or decrypt the data. Also see, **Encryption** and **Decrypting**.

L

laser scanner. A type of bar code reader that uses a beam of laser light.

LASER. (Light Amplification by Stimulated Emission of Radiation) The laser is an intense light source. Light from a laser is all the same frequency, unlike the output of an incandescent bulb. Laser light is typically coherent and has a high energy density.

Laser Diode. A gallium-arsenide semiconductor type of laser connected to a power source to generate a laser beam. This laser type is a compact source of coherent light.

LCD. See **Liquid Crystal Display**.

LEAP. (Lightweight Extensible Authentication Protocol) A mutual authentication method that uses a username and password system.

LED Indicator. A semiconductor diode (LED - Light Emitting Diode) used as an indicator, often in digital displays. The semiconductor uses applied voltage to produce light of a certain frequency determined by the semiconductor's particular chemical composition.

Liquid Crystal Display (LCD). A display that uses liquid crystal sealed between two glass plates. The crystals are excited by precise electrical charges, causing them to reflect light outside according to their bias. They use little electricity and react relatively quickly. They require external light to reflect their information to the user.

Light Emitting Diode. See **LED**.

M

MC. Mobile computer.

MDN. (Mobile Directory Number) The directory listing telephone number that is dialed (generally using POTS) to reach a mobile unit. The MDN is usually associated with a MIN in a cellular telephone -- in the US and Canada, the MDN and MIN are the same value for voice cellular users. International roaming considerations often result in the MDN being different from the MIN.

MIL. 1 mil = 1 thousandth of an inch.

MIN. (Mobile Identification Number) The unique account number associated with a cellular device. It is broadcast by the cellular device when accessing the cellular system.

Misread (Misdecode). A condition which occurs when the data output of a reader or interface controller does not agree with the data encoded within a bar code symbol.

Mobile Computer. In this text, mobile computer refers to the Zebra Series 9090 wireless portable computer. It can be set up to run as a stand-alone device, or it can be set up to communicate with a network, using wireless radio technology.

MS CHAP. (Microsoft Challenge Handshake Authentication Protocol) is the Microsoft version of CHAP and is an extension to RFC 1994. Like the standard version of CHAP, MS-CHAP is used for PPP authentication; in this case, authentication occurs between a PC using Microsoft Windows NT or Microsoft Windows 95 and a Cisco router or access server acting as a network access server (NAS).

N

Nominal. The exact (or ideal) intended value for a specified parameter. Tolerances are specified as positive and negative deviations from this value.

Nominal Size. Standard size for a bar code symbol. Most UPC/EAN codes are used over a range of magnifications (e.g., from 0.80 to 2.00 of nominal).

NVM. Non-Volatile Memory.

O

ODI. See **Open Data-Link Interface**.

Open Data-Link Interface (ODI). Novell's driver specification for an interface between network hardware and higher-level protocols. It supports multiple protocols on a single NIC (Network Interface Controller). It is capable of understanding and translating any network information or request sent by any other ODI-compatible protocol into something a NetWare client can understand and process.

Open System Authentication. Open System authentication is a null authentication algorithm.

P

PAN . Personal area network. Using Bluetooth wireless technology, PANs enable devices to communicate wirelessly. Generally, a wireless PAN consists of a dynamic group of less than 255 devices that communicate within about a 33-foot range. Only devices within this limited area typically participate in the network.

Parameter. A variable that can have different values assigned to it.

PC Card. A plug-in expansion card for laptop computers and other devices, also called a PCMCIA card. PC Cards are 85.6mm long x 54 mm wide, and have a 68 pin connector. There are several different kinds:
Type I; 3.3 mm high; use - RAM or Flash RAM
Type II; 5 mm high; use - modems, LAN adaptors
Type III; 10.5 mm high; use - Hard Disks

PCMCIA. Personal Computer Memory Card Interface Association. See **PC Card**.

Percent Decode. The average probability that a single scan of a bar code would result in a successful decode. In a well-designed bar code scanning system, that probability should approach near 100%.

PING. (Packet Internet Groper) An Internet utility used to determine whether a particular IP address is online. It is used to test and debug a network by sending out a packet and waiting for a response.

Print Contrast Signal (PCS). Measurement of the contrast (brightness difference) between the bars and spaces of a symbol. A minimum PCS value is needed for a bar code symbol to be scannable. $PCS = (RL - RD) / RL$, where RL is the reflectance factor of the background and RD the reflectance factor of the dark bars.

Programming Mode. The state in which a scanner is configured for parameter values. See **Scanning Mode**.

Q

Quiet Zone. A clear space, containing no dark marks, which precedes the start character of a bar code symbol and follows the stop character.

QWERTY. A standard keyboard commonly used on North American and some European PC keyboards. "QWERTY" refers to the arrangement of keys on the left side of the third row of keys.

R

RAM. Random Access Memory. Data in RAM can be accessed in random order, and quickly written and read.

Reflectance. Amount of light returned from an illuminated surface.

Resolution. The narrowest element dimension which is distinguished by a particular reading device or printed with a particular device or method.

RF. Radio Frequency.

ROM. Read-Only Memory. Data stored in ROM cannot be changed or removed.

Router. A device that connects networks and supports the required protocols for packet filtering. Routers are typically used to extend the range of cabling and to organize the topology of a network into subnets. See **Subnet**.

RS-232. An Electronic Industries Association (EIA) standard that defines the connector, connector pins, and signals used to transfer data serially from one device to another.

S

Scan Area. Area intended to contain a symbol.

Scanner. An electronic device used to scan bar code symbols and produce a digitized pattern that corresponds to the bars and spaces of the symbol. Its three main components are:

1. Light source (laser or photoelectric cell) - illuminates a bar code.
2. Photodetector - registers the difference in reflected light (more light reflected from spaces).
3. Signal conditioning circuit - transforms optical detector output into a digitized bar pattern.

Scanning Mode. The scanner is energized, programmed and ready to read a bar code.

Scanning Sequence. A method of programming or configuring parameters for a bar code reading system by scanning bar code menus.

SDK. Software Development Kit

Secure Sockets Layer (SSL). SSL is a commonly-used protocol for managing the security of a message transmission on the Internet. SSL uses a program layer located between the Internet's Hypertext Transfer Protocol (HTTP) and Transport Control Protocol (TCP) layers. SSL is included as part of both the Microsoft and Netscape browsers and most Web server products. Developed by Netscape, SSL also gained the support of Microsoft and other Internet client/server developers as well and became the de facto standard until evolving into Transport Layer Security. The "sockets" part of the term refers to the sockets method of passing data back and forth between a client and a server program in a network or between program layers in the same computer. SSL uses the public-and-private key encryption system from RSA, which also includes the use of a digital certificate.

Self-Checking Code. A symbology that uses a checking algorithm to detect encoding errors within the characters of a bar code symbol.

Shared Key. Shared Key authentication is an algorithm where both the AP and the MU share an authentication key.

SHIP. Symbol Host Interface Program.

SID. System Identification code. An identifier issued by the FCC for each market. It is also broadcast by the cellular carriers to allow cellular devices to distinguish between the home and roaming service.

SMDK. Symbol Mobility Developer's Kit.

Soft Reset. See **Warm Boot**.

Space. The lighter element of a bar code formed by the background between bars.

Specular Reflection. The mirror-like direct reflection of light from a surface, which can cause difficulty decoding a bar code.

Start/Stop Character. A pattern of bars and spaces that provides the scanner with start and stop reading instructions and scanning direction. The start and stop characters are normally to the left and right margins of a horizontal code.

STEP. Symbol Terminal Enabler Program.

Subnet. A subset of nodes on a network that are serviced by the same router. See **Router**.

Subnet Mask. A 32-bit number used to separate the network and host sections of an IP address. A custom subnet mask subdivides an IP network into smaller subsections. The mask is a binary pattern that is matched up with the IP address to turn part of the host ID address field into a field for subnets. Default is often 255.255.255.0.

Substrate. A foundation material on which a substance or image is placed.

SVTP. Symbol Virtual Terminal Program.

Symbol. A scannable unit that encodes data within the conventions of a certain symbology, usually including start/stop characters, quiet zones, data characters and check characters.

Symbol Aspect Ratio. The ratio of symbol height to symbol width.

Symbol Height. The distance between the outside edges of the quiet zones of the first row and the last row.

Symbol Length. Length of symbol measured from the beginning of the quiet zone (margin) adjacent to the start character to the end of the quiet zone (margin) adjacent to a stop character.

Symbology. The structural rules and conventions for representing data within a particular bar code type (e.g. UPC/EAN, Code 39, PDF417, etc.).

T

TCP/IP. (Transmission Control Protocol/Internet Protocol) A communications protocol used to internetwork dissimilar systems. This standard is the protocol of the Internet and has become the global standard for communications. TCP provides transport functions, which ensures that the total amount of bytes sent is received correctly at the other end. UDP is an alternate transport that does not guarantee delivery. It is widely used for real-time voice and video transmissions where erroneous packets are not retransmitted. IP provides the routing mechanism. TCP/IP is a routable protocol, which means that all messages contain not only the address of the destination station, but the address of a destination network. This allows TCP/IP messages to be sent to multiple networks within an organization or around the

world, hence its use in the worldwide Internet. Every client and server in a TCP/IP network requires an IP address, which is either permanently assigned or dynamically assigned at startup.

Telnet. A terminal emulation protocol commonly used on the Internet and TCP/IP-based networks. It allows a user at a terminal or computer to log onto a remote device and run a program.

Terminate and Stay Resident (TSR). A program under DOS that ends its foreground execution to remain resident in memory to service hardware/software interrupts, providing background operation. It remains in memory and may provide services on behalf of other DOS programs.

Terminal Emulation. A “terminal emulation” emulates a character-based mainframe session on a remote non-mainframe terminal, including all display features, commands and function keys. The MC909X Series supports Terminal Emulations in 3270, 5250 and VT220.

TFTP. (Trivial File Transfer Protocol) A version of the TCP/IP FTP (File Transfer Protocol) protocol that has no directory or password capability. It is the protocol used for upgrading firmware, downloading software and remote booting of diskless devices.

TKIP. (Temporal Key Integrity Protocol) A wireless encryption protocol that periodically changes the encryption key, making it harder to decode.

Tolerance. Allowable deviation from the nominal bar or space width.

Transmission Control Protocol/Internet Protocol. See **TCP/IP**.

TLS. (Transport Layer Security) TLS is a protocol that ensures privacy between communicating applications and their users on the Internet. When a server and client communicate, TLS ensures that no third party may eavesdrop or tamper with any message. TLS is the successor to the Secure Sockets Layer (SSL).

Trivial File Transfer Protocol. See **TFTP**.

TSR. See **Terminate and Stay Resident**.

U

UPC. (Universal Product Code) A relatively complex numeric symbology. Each character consists of two bars and two spaces, each of which is any of four widths. The standard symbology for retail food packages in the United States.

UDP. (User Datagram Protocol) A protocol within the IP protocol suite that is used in place of TCP when a reliable delivery is not required. For example, UDP is used for real-time audio and video traffic where lost packets are simply ignored, because there is no time to retransmit. If UDP is used and a reliable delivery is required, packet sequence checking and error notification must be written into the applications.

U

Visible Laser Diode (VLD). A solid state device which produces visible laser light.

W

Warm Boot. A warm boot restarts the mobile computer by closing all running programs. All data that is not saved to flash memory is lost.

WAP. (Wireless Application Protocol) A set of specifications, developed by the WAP Forum, that lets developers using Wireless Markup Language build networked applications designed for handheld wireless devices. WAP was designed to work within the constraints of these devices: a limited memory and CPU size, small, monochrome screens, low bandwidth and erratic connections.

WEP. Wired-Equivalent Privacy protocol was specified in the IEEE 802.11 standard to provide a WLAN with a minimal level of security and privacy comparable to a typical wired LAN, using data encryption.

WPA. Wi-Fi Protected Access is a data encryption specification for 802.11 wireless networks that replaces the weaker WEP. It improves on WEP by using dynamic keys, Extensible Authentication Protocol to secure network access, and an encryption method called Temporal Key Integrity Protocol (TKIP) to secure data transmissions.

WPA2. Wi-Fi Protected Access 2 is an enhanced version of WPA. It uses Advanced Encryption Standard instead of TKIP.

WLAN. Wireless local-area networks use radio waves instead of a cable to connect a user device, such as a mobile computer, to a LAN. They provide Ethernet connections over the air and operate under the 802.11 family of specifications developed by the IEEE.

Index

Numerics

1-D bar codes	2-46
28-key keypad	2-11
28-key keypad (MC909X-S)	2-12
2-D bar codes	2-46
3270 emulator keypad	2-34
33-key numeric keypad (MC909X-K)	2-16
38-key alpha/shifted numeric keypad (MC909X-S)	2-24
38-key numeric keypad (MC909X-S)	2-20
43-key keypad	2-27
5250 emulator keypad	2-37
53-key keypad	2-31

A

AC power	6-13
accessories	1-4
accessory keyboard	1-4
auto charge cable	6-1
cables	1-4, 6-1
CAM	1-4, 6-1, 6-15
installation	6-15
DEX cable	1-4, 6-1
four slot charge only cradle	1-4, 6-1, 6-9
four slot Ethernet cradle	6-7
four slot Ethernet/USB cradle	1-4, 6-1
four slot spare battery charger	1-4
headphone	1-4
holster, quick release	1-4
keypad	6-1
magnetic stripe reader	1-4, 6-1
modem module	1-5
MSR	6-11
battery charging	6-13, 6-18
installation	6-12
magnetic stripe reading	6-14

power connection	6-16
serial connection	6-13, 6-17
printer cable	1-4, 6-1
serial/USB cradle	1-5, 6-1
shelf slide	1-5
SIM card	1-11
single slot serial/USB cradle	6-5, 6-22
LED indicators	6-7, 6-11
SMDK	1-5
spare battery	1-5
spare battery charger	6-10
power connection	6-10
storage card	1-5
stylus	1-5
UBC	
battery insertion	6-18
UBC adapter	1-5
USB charger cable	1-4, 6-1
wall mounting bracket	1-5
accessory keyboard	1-4
ActiveSync	
icon	2-5
Adaptive Frequency Hopping	3-1
AFH	3-1
aiming options	
aiming pattern	2-47
aiming the imager	2-46
aligning screen	1-10
answering a call	4-2, 5-9
attaching MC9090-G strap	1-14
attaching MC909X-K strap	1-15
attaching MC909X-S strap	1-16
auto charge cable	6-1

B

backlight	2-43
-----------	------

- backlight intensity 2-43
- backup battery 2-2
 - charging 1-7
- bar codes
 - one dimensional 2-46
 - two dimensional 2-46
- battery
 - backup charging 1-7
 - charging 1-7
 - check status 1-10
 - installing 1-6
 - removing 1-8
- battery charging temperature A-2
- battery icon 2-2
- battery management 1-17
- battery status 2-2
- beeper volume 2-43
- bluetooth
 - adaptive frequency hopping 3-1
 - bonding 3-9
 - communicating icon 2-2, 2-5
 - deleting bonded device 3-11
 - disabled icon 2-2, 2-5
 - discovering devices 3-8
 - enabled icon 2-2, 2-5
 - renaming bonded device 3-11
 - turning off 3-2
 - turning on 3-3
- Bluetooth security 3-2
- bonding, bluetooth 3-9
- boot
 - cold 1-10, 2-44, 2-45, 2-49, 2-50, 3-3
 - warm 2-44, 2-45, 2-49, 2-50, 3-3
- bullets xi
- buttons
 - power 1-13, 2-44

C

- Cable Adapter Module 1-4, 6-1
- cables 1-4, 6-1
 - auto charge cable 6-1
 - DEX cable 1-4, 6-1
 - printer cable 1-4, 6-1
 - USB charger 1-4, 6-1
- calibrating screen 1-10
- call history 4-2, 4-4, 4-10, 5-17, 5-22
- CAM 1-4, 6-1, 6-15
 - installation 6-15
- changing the power settings 1-17
- characters, special B-1
- charging
 - spare batteries 1-8
- charging batteries 1-7

- charging spare batteries 1-8
- cleaning 7-1
- cold boot 1-10, 2-44, 2-45, 2-49, 2-50, 3-3
- command bar
 - icons 2-3, 2-5
- command bar icons 2-4
- conference call 4-16
- configuration vi, 1-6
- configurations vi
- contacts
 - phone 4-14
- contacts application 4-14
- contrast 2-43
- conventions
 - notational xi
- CPU A-2
- cradles
 - four slot charge only 1-4, 6-1, 6-9
 - four slot Ethernet 6-7
 - four slot Ethernet/USB 1-4, 6-1
 - serial/USB 1-5, 6-1
 - single slot 6-5, 6-22
 - LED indicators 6-7, 6-11
 - spare battery charger 6-10
 - power connection 6-10
- current time 2-2

D

- data capture vi, 2-46
 - adjusting the distance 2-49
 - imager operational modes
 - decode mode 2-47
 - image capture mode 2-47
 - pick list mode 2-47
 - imaging 2-46
 - indicator 2-49
 - laser scanning 2-46
 - one dimensional bar codes 2-46
 - scan angle 2-47
 - scan range 2-47
 - scanning 2-48
 - two dimensional bar codes 2-46
- date/time 2-2
- DCP for MC9090c50 xi
- deleting bluetooth bond 3-11
- Device Configuration Package 1-5
- Device Configuration Package for MC9090c50 xi
 - DEX cable 1-4, 6-1
- dimensions A-1
- disconnecting 4-20
- display vi, A-1
- display backlight
 - saving power 1-17

display backlight intensity 2-43
display contrast 2-43
drop specification A-2

E

electrical safety A-5
electro-static discharge
email notification icon 2-4
ESD 6-2, 6-3

F

flash card 1-5, 6-3
four slot charge only 1-4, 6-1
four slot charge only cradle 6-9
four slot Ethernet cradle 6-7
four slot Ethernet/USB 1-4, 6-1
four slot spare battery charger 1-4

G

getting started 1-6
GPRS 4-1, 5-1
GPRS data connection 4-18, 5-15
GPRS data disconnect 4-20
GSM 4-1, 5-1
 GPRS data connection 4-18, 5-15

H

hard reset 1-10, 2-44, 2-45, 2-49, 2-50, 3-3
headphone 1-4
headset 2-45, 2-46, 4-3
holster 1-4
humidity A-2

I

icon
 battery status 2-2
icons
 ActiveSync 2-5
 alpha mode 2-2
 ALT 2-2
 battery 2-3
 bluetooth communicating 2-2, 2-5
 bluetooth disabled 2-2, 2-5
 bluetooth enabled 2-2, 2-5
 connectivity 2-3
 CTRL 2-2
 e-mail 2-4
 function 2-2
 instant message 2-4

phone edition 2-4
shift 2-2
speaker 2-3
status 2-3, 2-5
wireless applications 2-5
WWAN 2-4

imager. See data capture, imaging, imagersample

imaging 2-46
incoming call features 4-3
information, service xii
installing main battery 1-6
internet
 disconnecting GPRS 4-20
 via GPRS 4-18, 5-15

K

key descriptions
 28-key 2-13
 3270 2-35
 43-key 2-17, 2-28
 5250 2-38
 53-key 2-32
 special functions 2-43
 vt 2-41
keyboard A-1
keyboard input panel 2-2
keypad 6-1
 28-key B-1
 33-key B-1
 38-key B-1
 48-key B-1
 53-key B-1
keypad backlight
 saving power 1-18
keypad functions x, B-1
keypad, phone 4-1, 5-3
keypads vi
 28-key 2-11
 3270 emulator 2-34
 43-key 2-27
 5250 emulator 2-37
 53-key 2-31
 MC909X-K
 33-key numeric 2-16
 MC909X-S
 28-key 2-12
 38-key alpha/shifted numeric 2-24
 38-key numeric 2-20
 special functions 2-43
 types 2-10, 6-1
 vt emulator 2-40

L

- laser safety A-5
- laser scanning
 - See data capture 2-46
- LED Indicator Bar 2-9
- lithium-ion battery 1-4
- locking the mobile computer 2-8

M

- magnetic stripe reader 1-4, 6-1, 6-11
- main battery
 - charging 1-6, 1-7
 - installing 1-6
- maintenance 7-1
- MC9094 phone 4-1, 5-1
- MDM9000 1-5
- memory vi, A-2
- MMC 6-3
- mobile computer
 - power on 2-44
 - starting 1-10
- mobile computer configuration 1-6
- modem module 1-5
- MSR 1-4, 6-1, 6-11
 - battery charging 6-13, 6-18
 - installation 6-12
 - magnetic stripe reading 6-14
 - power connection 6-16
 - serial connection 6-13, 6-17
- multi media card 6-3
- muting a call 4-4, 5-18

N

- notes application 4-4, 5-16

O

- operating environment, mobile computer A-1
- operating system vi, A-2
- operating temperature A-2

P

- parts of the mobile computer 1-1
 - front view 1-2, 1-3
- phone 4-1, 5-1
 - answering a call 4-2, 5-9
 - call history 4-10, 5-22
 - call swapping 4-15
 - conference call 4-16
 - contacts 4-14

- headset mode 4-3
- keypad 4-1, 5-3
- muting a call 4-4, 5-18
- speaker mode 4-3
- speed dial
 - adding entry 4-5
 - deleting entry 4-8
 - editing entry 4-8
- speed dial calling 4-9
- taking notes 4-4, 5-16
- text messaging 4-17
- three-way call 4-16
- using contacts 4-14
- using keypad 4-2, 5-7

pin-outs

- accessory A-9
- mobile computer A-8
- power button 1-13, 2-44
- power settings 1-17
- power supply regulatory compliance C-1
- printer cable 1-4, 6-1

Q

- quick release holster 1-4

R

- radios vi
- regulatory compliance, power supply C-1
- related documents xi
- related software xi
- removing main battery 1-8
- renaming bluetooth bond 3-11
- reset
 - hard 1-10, 2-44, 2-45, 2-49, 2-50, 3-3
 - soft 2-44, 2-45, 2-49, 2-50, 3-3
- resetting 2-49
- resume 3-4

S

- scan status 2-49
- scan status *See also* data capture
- scanning
 - bar codes 2-48
 - imaging 2-46
 - LED indicators 2-49
 - See data capture 2-46
- screen
 - calibration 1-10
 - splash window 1-10
- SD 6-3
- secure device card 6-3

serial/USB cradle 1-5, 6-1
 shelf slide 1-5
 short battery adapter 6-6
 SIM card
 accessories 1-11
 install 1-11
 single slot serial/USB cradle 6-5, 6-22
 LED indicators 6-7, 6-11
 SMDK for eVC4xi
 SMS
 sending a message 4-17
 soft keyboard 2-2
 soft reset 2-44, 2-45, 2-49, 2-50, 3-3
 spare batteries
 charging 1-8
 spare battery 1-5
 charging 1-8
 spare battery charger 6-10
 power connection 6-10
 special characters B-1
 specifications A-1
 speed dial 4-5, 4-9, 5-18
 starting the mobile computer 1-6, 1-10
 status 2-1, 2-3
 status icon 2-1, 2-2, 2-3
 phone 2-4
 WWAN 2-4
 status icons 2-3, 2-5
 Windows CE 5.0 2-1
 Windows Mobile 5.0 2-3
 storage card 1-5
 SD card
 MMC card 1-5
 storage temperature A-2
 strap 1-4, 1-14
 attaching to the MC9090-G 1-14
 attaching to the MC909X-K 1-15
 attaching to the MC909X-S 1-16
 stylus 1-4, 1-5, 1-13
 subscriber identification module 1-11
 suspend 1-8, 2-44, 3-4
 Symbol Mobility Developer Kit
 See SMDK 1-5
 Symbol Mobility Developer Kit for eVC4xi

T

taskbar 2-1, 2-3
 technical specifications, mobile computer A-1
 technical specifications, modem module A-6
 terminal
 charging 2-2
 terminal charging 2-2
 three-way call 4-16

troubleshooting 7-3
 bluetooth 7-5
 cable adapter module 7-11
 four slot charge cradle 7-6
 four slot ethernet cradle 7-7
 four slot spare battery charger 7-9
 magnetic stripe reader 7-11
 mobile computer 7-3
 modem module 7-13
 single slot serial/USB cradle 7-10
 turning the radios off
 WLAN 1-20, 1-21

U

UBC 6-18
 UBC adapter 1-5
 universal battery charger 6-18
 unlock the mobile computer 2-9
 unpacking 1-4
 USB charger 1-4, 6-1
 using headset 2-45, 2-46
 using stylus 1-13

V

volume 2-43
 vt emulator keypad 2-40

W

wall mounting bracket 1-5
 warm boot 2-44, 2-45, 2-49, 2-50, 3-3
 weight A-1
 Wireless 1-19, 5-4
 Wireless Manager 1-19, 5-4
 wireless status 2-5
 wireless status icon 2-2
 WLAN 802.11a/b/g vi
 WLAN status 2-2
 WPAN Bluetooth vi
 WWAN 4-1, 5-1



Zebra Technologies Corporation
Lincolnshire, IL U.S.A.
<http://www.zebra.com>

Zebra and the stylized Zebra head are trademarks of ZIH Corp., registered in many jurisdictions worldwide. All other trademarks are the property of their respective owners.

©2015 ZIH Corp and/or its affiliates. All rights reserved.