



# **CSL CS203ETHER-LHCP/RHCP EPC Class 1 Gen 2 RFID INTEGRATED Reader**

**User's Manual**

**Version 2.0.1**

***CSL: The One-Stop-Shop for RFID Solutions***

# 1 Content

<b>1</b>	<b>CONTENT</b> .....	<b>2</b>
<b>2</b>	<b>FCC STATEMENT</b> .....	<b>5</b>
<b>3</b>	<b>INTRODUCTION</b> .....	<b>6</b>
3.1	PRODUCT PACKAGE .....	6
3.1.1	BASIC PACKAGE CONTENT.....	6
3.1.2	PRODUCT SPECIFICATIONS .....	7
<b>4</b>	<b>HARDWARE INSTALLATION</b> .....	<b>9</b>
4.1	HARDWARE CONTENT OF SHIPMENT PACKAGE .....	9
4.1.1	CS203 READER.....	10
4.2	MOUNTING .....	11
4.3	OPERATING SETUP .....	12
4.4	CABLE CONNECTION FOR CS203 .....	14
4.4.1	ETHERNET CABLE CONNECTION FOR CS203 .....	14
4.4.2	GPIO CABLE CONNECTION FOR CS203 .....	19
4.4.3	CSL GPIO BOARD.....	23
4.5	READER MECHANICAL MOUNTING.....	24
<b>5</b>	<b>SOFTWARE INSTALLATION</b> .....	<b>25</b>
5.1	SOFTWARE CONTENT OF SHIPMENT PACKAGE .....	25
5.2	PC SIDE PREREQUISITES .....	27
5.3	DEFAULT EX-FACTORY IP SETTINGS .....	27
5.4	CHANGING IP ADDRESS .....	28
5.5	DEMO APPLICATION - "C# NATIVE SINGLE READER ON WINDOWS OS WITH USER INTERFACE".....	29
5.5.1	HARDWARE SETUP.....	29
5.5.2	SOFTWARE SETUP .....	29
5.5.3	SEARCH CS203.....	30
5.5.4	ASSIGN CS203 IP AND TCP TIMEOUT.....	31
5.5.5	STATUS VERIFICATION .....	32
5.6	EXCEPTION SITUATIONS.....	33
5.7	FINDING A "LOST" CS203 .....	34
<b>6</b>	<b>C# DEMO APPLICATION PROGRAM OPERATION</b> .....	<b>37</b>
6.1	SEARCHING FOR CS203 DEVICE.....	37
6.2	NETWORK CONFIGURATION OF CS203 .....	38

6.3	CONNECTING TO CS203 .....	39
6.4	MAIN MENU .....	40
6.5	INVENTORY .....	41
6.6	READ / WRITE .....	43
6.7	WRITE ANY .....	48
6.8	GEIGER COUNTER SEARCH .....	49
6.9	TAG SECURITY .....	50
6.10	USER PERM-LOCK .....	52
6.11	KILL .....	55
6.12	SETUP .....	56
6.13	GPIO CONTROL .....	56
6.14	MIDDLEWARE CONNECTIVITY .....	60
<b>7</b>	<b>READER CONFIGURATION .....</b>	<b>61</b>
7.1	READER CONFIGURATION OVERVIEW .....	61
7.2	IP CONFIGURATION (C# AND JAVA DEMO APP) .....	62
7.3	RECONNECT TIMEOUT (C# DEMO APP) .....	63
7.4	INTERFACE TO READER (C# DEMO APP) .....	64
7.5	ANTENNA PORT AND SEQUENCE (C# AND JAVA DEMO APP) .....	65
7.6	POWER LEVEL (C# AND JAVA DEMO APP) .....	69
7.7	COUNTRY, FREQUENCY AND FIXED CHANNEL (C# AND JAVA DEMO APP) .....	71
7.8	RSSI FILTER (C# AND JAVA DEMO APP) .....	79
7.9	LINK PROFILE (C# AND JAVA DEMO APP) .....	84
7.10	TARGET AND TOGGLE A / B FLAG (C# AND JAVA DEMO APP) .....	87
7.11	SESSION AND TAG SELECTION (C# AND JAVA DEMO APP) .....	89
7.12	SLOT-COUNT PARAMETER Q AND DWELL TIME (C# AND JAVA DEMO APP) .....	90
7.13	INVENTORY ALGORITHM: FIX Q AND DYNAMIC Q ALGORITHM (C# AND JAVA DEMO APP) .....	91
7.14	READ TID, USER BANK AND SAVE TAG DATA IN LOG FILE (C# DEMO APP) .....	95
<b>8</b>	<b>PC SOFTWARE UPGRADE .....</b>	<b>102</b>
8.1	PC DEMO APPLICATION UPGRADE .....	102
8.2	PC DEMO APPLICATION UPGRADE - FOR USER .....	103
8.3	PC DEMO APPLICATION UPGRADE - FOR DEVELOPER .....	105
<b>9</b>	<b>SOFTWARE DEVELOPMENT KIT FOR DEVELOPER .....</b>	<b>108</b>
9.1	INTRODUCTION .....	108
9.2	PROGRAM STRUCTURE .....	108
9.3	BUILD PROJECT REQUIREMENTS .....	109
<b>10</b>	<b>READER FIRMWARE UPGRADE .....</b>	<b>110</b>

10.1	READER CONNECTION .....	110
10.2	FIRMWARE UPGRADE PROCEDURE OVERVIEW.....	111
10.3	NETWORK PROCESSOR FIRMWARE UPGRADE PROCEDURE .....	113
10.4	RFID PROCESSOR FIRMWARE UPGRADE PROCEDURE.....	121
10.4.1	PROCEDURE FOR CSL READER WITH RFID PROCESSOR APP VERSION 1.3.XX OR 1.4.XX .....	121
10.4.2	PROCEDURE FOR CSL READER WITH RFID PROCESSOR APP VERSION 1.5.XX OR AFTER .....	131
<b>11</b>	<b>REGULATORY INFORMATION .....</b>	<b>141</b>
11.1	FEDERAL COMMUNICATIONS COMMISSION (FCC) COMPLIANCE.....	141
<b>APPENDIX A. RFID BASICS .....</b>		<b>142</b>
<b>APPENDIX B. OPERATION PROFILES AND GEN2 PARAMETERS .....</b>		<b>143</b>
<b>APPENDIX C. RF CHANNELS .....</b>		<b>147</b>
<b>APPENDIX D. COMMON MISTAKES .....</b>		<b>149</b>
<b>APPENDIX E. TECHNICAL SUPPORT .....</b>		<b>150</b>

## 2 FCC Statement

FCC NOTICE: To comply with FCC part 15 rules in the United States, the system must be professionally installed to ensure compliance with the Part 15 certification. It is the responsibility of the operator and professional installer to ensure that only certified systems are deployed in the United States. The use of the system in any other combination is expressly forbidden. This equipment complies with FCC radiation exposure limits set forth for an uncontrolled environment. This equipment should be installed and operated with minimum distance 20cm between the radiator & your body.

## **3 Introduction**

### **3.1 Product Package**

#### **3.1.1 Basic Package Content**

The reader package contains:

- Integrated reader
- waterproof LAN Cable for converting to regular RJ45 Ethernet connector (crossover)
- 12V switching power supply
- GPIO cable
- Extended mounting stud and nuts
- Plastic caps for connectors and cables

## 3.1.2 Product Specifications



Fig 3-1 CS203ETHER-2 Reader

### Features:

- ISO 18000-6C and EPCglobal Class 1 Gen 2 UHF RFID protocol compliant including dense reader mode
- Ultra long read range –13 meters with DogBone tags from Smartrac (FCC version)
- Ultra high read rate – peak at 300 tags per second
- Choices of right hand circular polarization antenna version and left hand circular polarization antenna version for different application scenarios
- 400 kbps tag-to-reader data rate profile
- Robust performance in dense-reader environments
- Excellent in transmit and receive mode – generates a different combination of unique reader-to-tag command rate, tag-to-reader backscatter rate, modulation format, and backscatter type
- Configurable parameters offer maximum throughput and optimal performance
- Supports all Gen 2 commands, including write, lock and kill

**Specifications:**

<b>Physical Characteristics:</b>	Length: 30 cm; Width: 30 cm; Height: 7.5 cm; Weight: 2 Kg
<b>Environment:</b>	Operating Temp: -20 <sup>0</sup> C to 60 <sup>0</sup> C Storage Temp: -40 <sup>0</sup> C to 85 <sup>0</sup> C Humidity: 98% non-condensing Enclosure: IP-68 Shock and Vibration: MIL-STD-810
<b>Antenna:</b>	Choice of: Left Hand Circular Polarized Antenna (LHCP) Right Hand Circular Polarized Antenna (RHCP)
<b>Power:</b>	12 Volt supplied via an AC/DC adaptor or IEEE 802.3at (PoE+) compliant Power Over Ethernet enabled power source (Max. consumption on PoE: ~ 18W)
<b>RFID Frequency Ranges:</b>	865 – 868 MHz, 902-928 MHz bands
<b>Interfaces</b>	LAN TCP/IP (Configurable to use fixed IP address or DHCP)
<b>Maximum Tag Read Rate:</b>	150 tags/sec. (dense reader mode)
<b>Maximum Speed of Tag:</b>	660 ft/min
<b>Accessories:</b>	<ul style="list-style-type: none"> <li>• SFTP waterproof LAN Cable for converting to regular RJ45 Ethernet connector (crossover)</li> <li>• 12V switching power supply</li> <li>• GPIO cable</li> <li>• Extended mounting stud and nuts</li> <li>• Plastic caps for connectors and cables</li> </ul>
<b>Order Code:</b>	CS203ETHER- <b>N</b> XHCP N=1: 865-868 MHz (Europe) & 865-867 MHz (India), N=2: 902-928 MHz (USA), N=4: 922-928 MHz (Taiwan), N=7: 920-925 MHz (China, Australia, Malaysia, Hong Kong etc.), N=8: 915-922 MHz (Japan)  X=L: LHCP; X=R: RHCP
<b>Restrictions on Use:</b>	Approvals, features and parameters may vary depending on country legislation and may change without notice



## 4 Hardware Installation

### 4.1 Hardware Content of Shipment Package

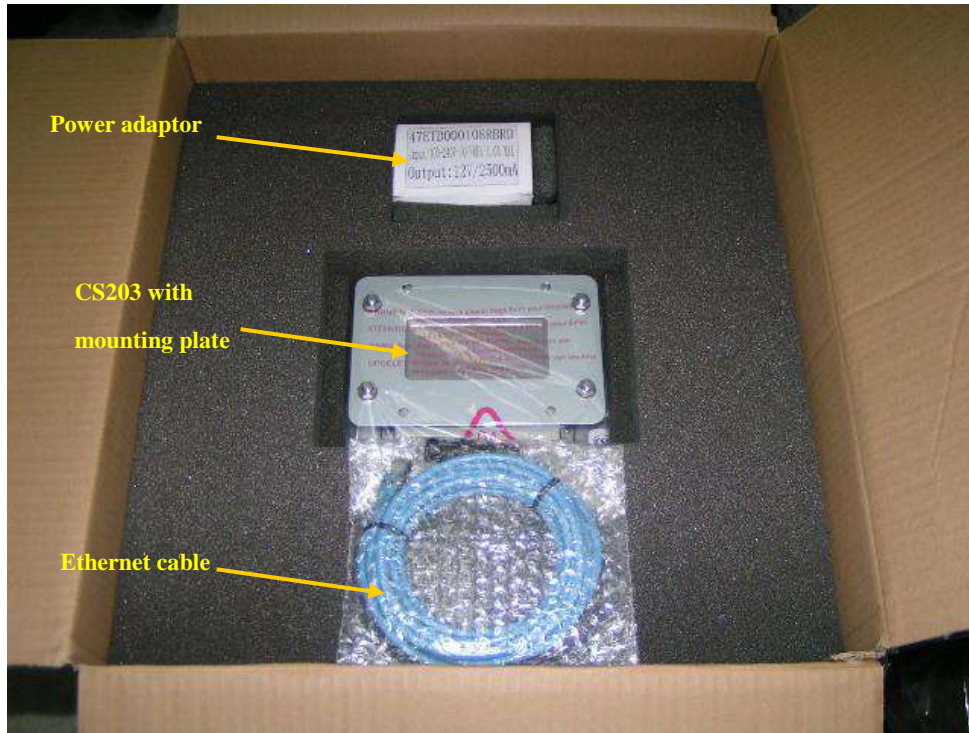

Figure 4-1 Packing Content

### 4.1.1 CS203 Reader

The CSL CS203ETHER-2 integrated RFID Reader is an EPCglobal Class 1 Gen 2 integrated reader product.



Figure 4-2 CS203ETHER Reader Side View



Figure 4-3 CS203ETHER Reader Side View



Figure 4-4 CS203ETHER Reader Side View

## 4.2 Mounting



Figure 4-5 CS203ETHER Mounting

## 4.3 Operating Setup

CS203ETHER-2 has two power-up modes: POE mode and 12V power supply mode.



Figure 4-6 POE adaptor Setup

The reader is connected to POE adaptor's output port via the cable provided in the package. The input port of POE adaptor is connected to a host computer.

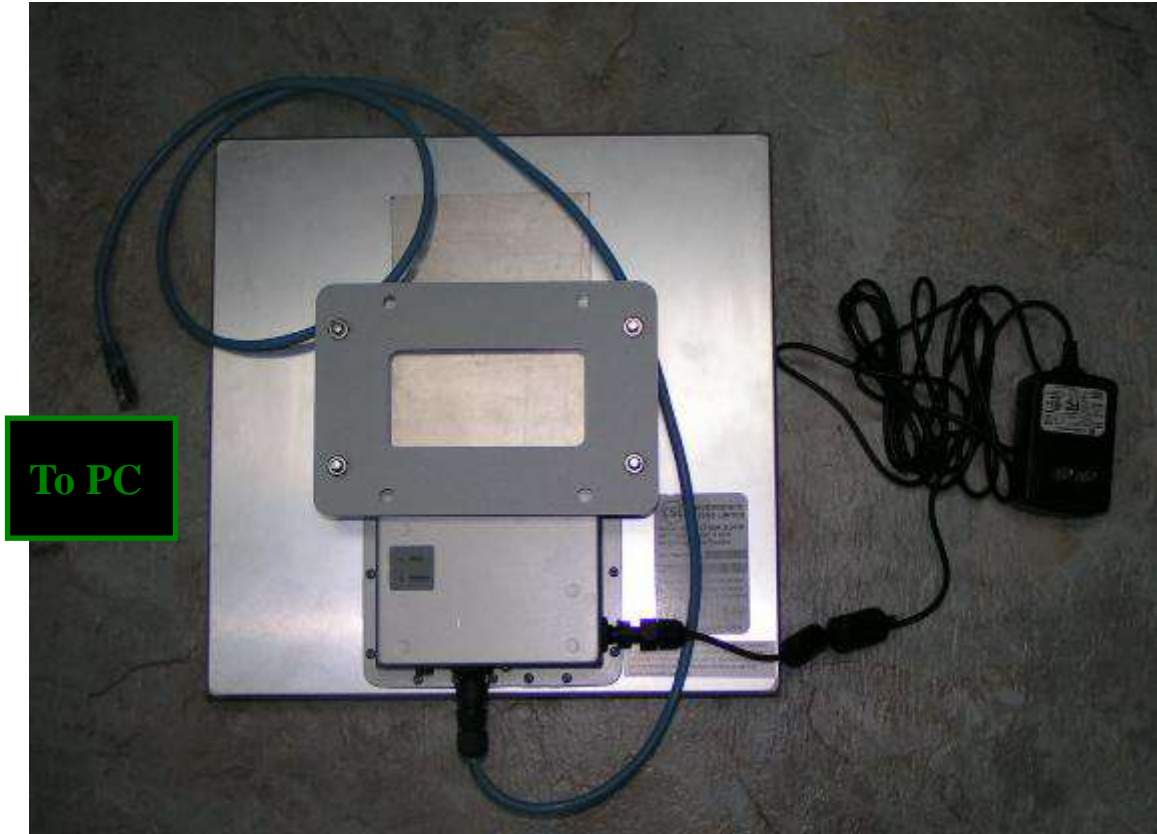

**Figure 4-7 12V power supply Setup**

The reader is directly connected to a host computer via the cable provided in the package.

## 4.4 Cable Connection for CS203

### 4.4.1 Ethernet Cable Connection for CS203

For Ethernet cable, remove the protective plug first followed with the below procedure.



Rotate the security cap and then pull out the protective cover.

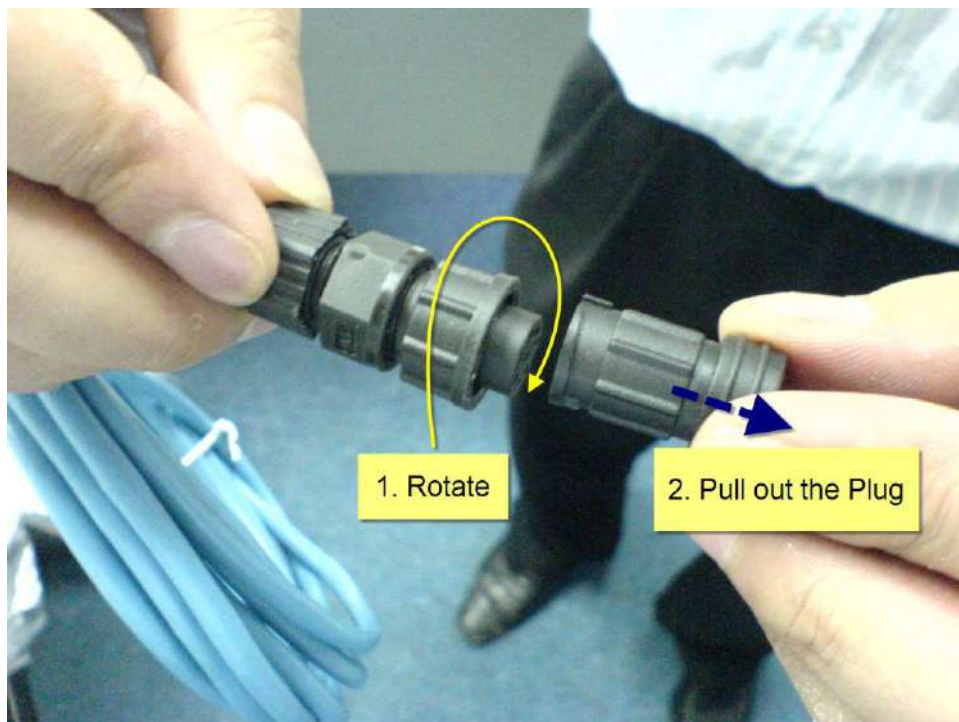

Align the engagement pin with the rib on the Ethernet cable socket on the CS203.

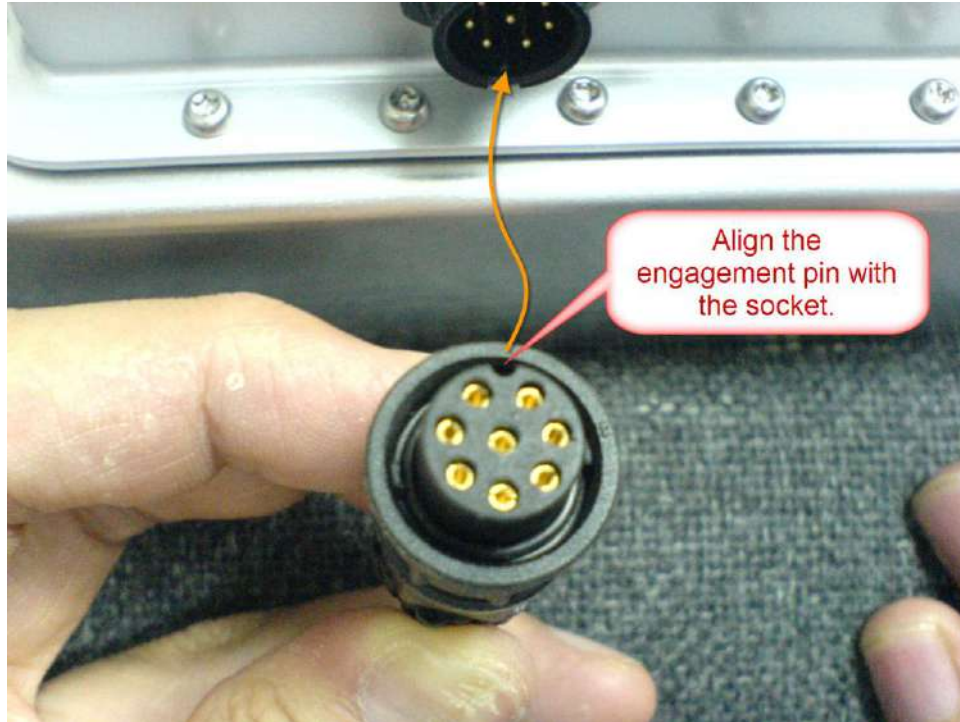

Engage the pins on the connector and push fully the cable head to the socket.

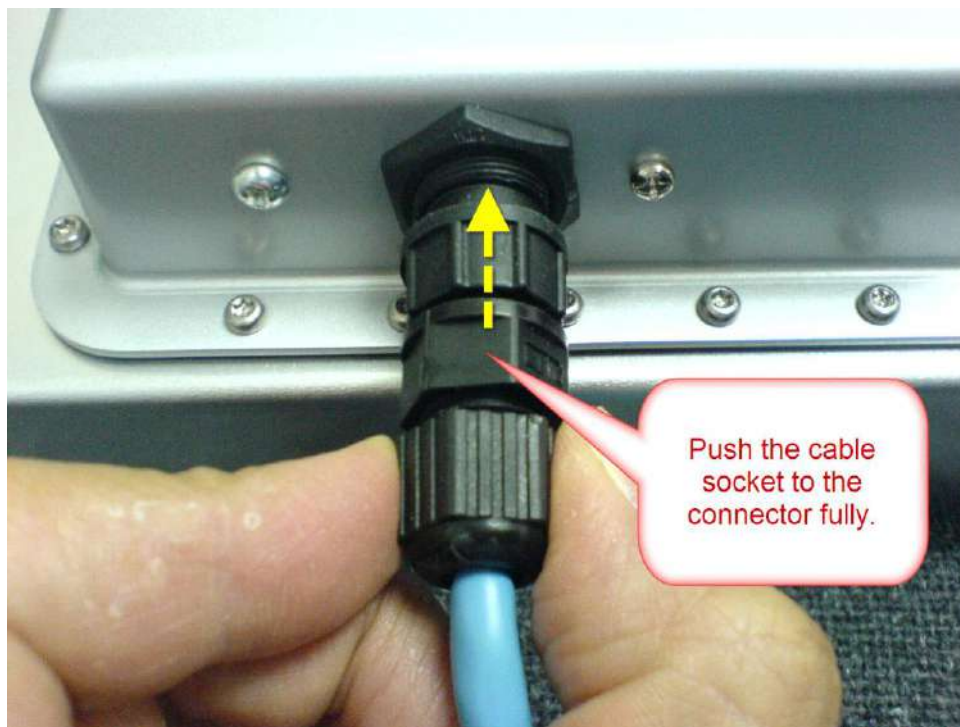

Secure the Ethernet cable engagement by rotating the cap to the "LOCK" position on the cable gland. **Finish.**



For DC connector, remove the protective cap. Connect the DC adaptor cable to the socket in the same manner as the Ethernet connector. **Finish.**

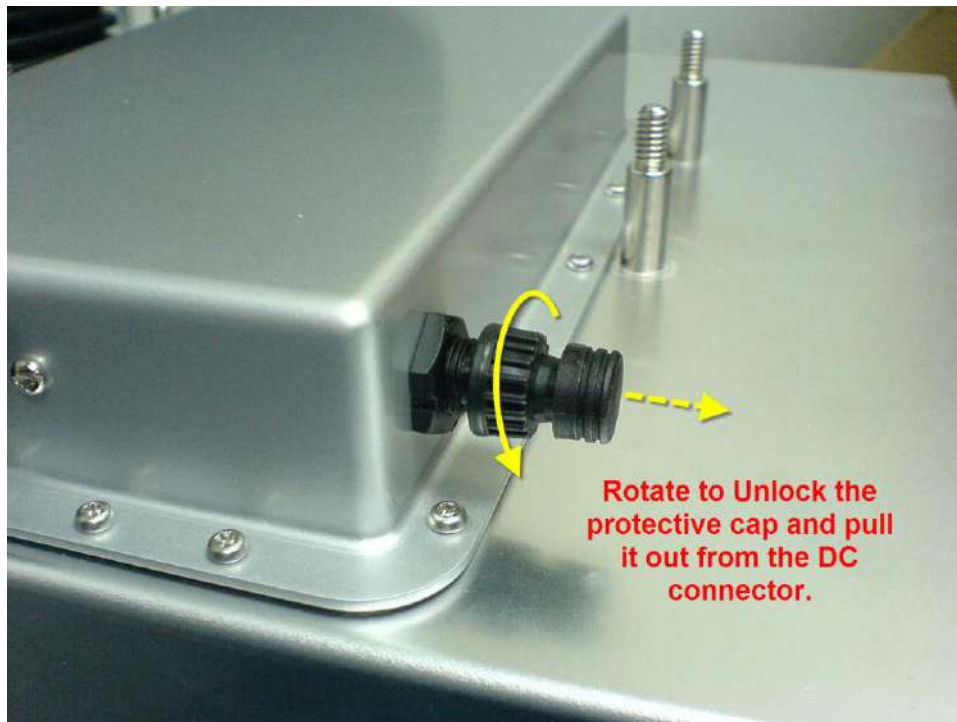



**Ethernet cable (RJ45) to 8-pin waterproof connector.**

Housing A: RJ-45 connector

Wiring Color Scheme:

**TIA/EIA 568A Wiring**



**TIA/EIA 568B Wiring**

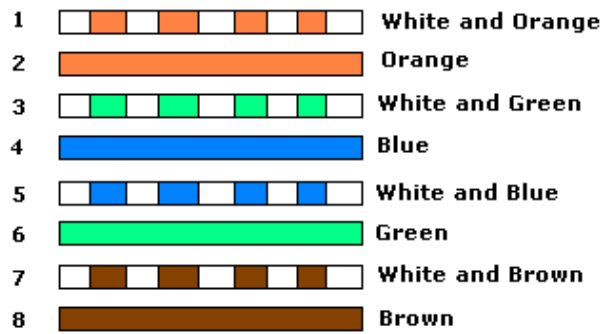

1	TX+
2	TX-
3	RX+
4	NC
5	NC
6	RX-
7	NC
8	NC

Housing B: 8-pin waterproof connector, LTWBD-08BFFA-LL7001

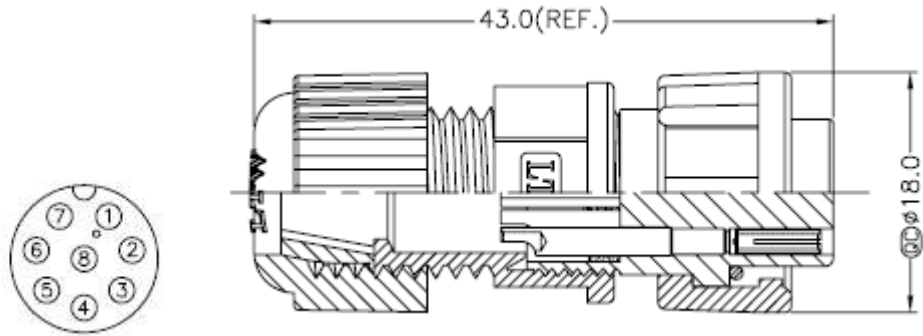

1	TX-
2	TX+
3	RX-
4	RX+
5	SP1
6	SP2
7	GND
8	GND

Connection

RJ-45 cable	LTWBD-08BFFA-LL7001
1	2
2	1
3	4
4	5
5	5
6	3
7	6
8	6
GND (shielded braided wire)	7
GND (shielded braided wire)	8

## 4.4.2 GPIO Cable Connection for CS203

### Pin Assignment:

The pin assignment of the GPIO cable is as below.

Housing A: Open

Housing B: 8-pin waterproof connector, LTWBD-08BFFA-LL7001

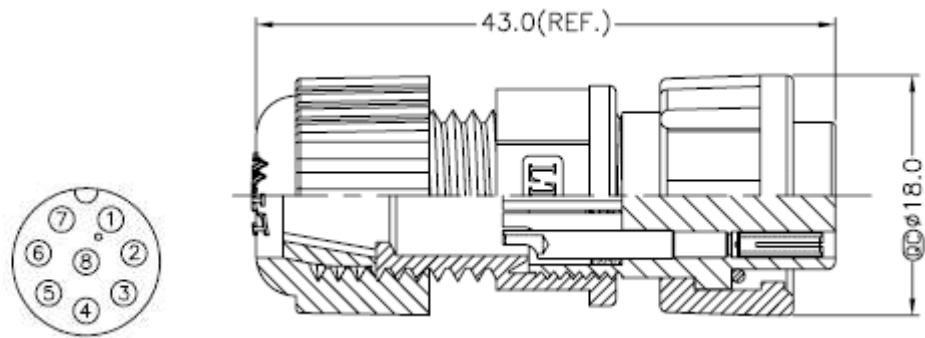

### Connection

1	GND	Black
2	GPI 1	Red
3	GPO 1	Green
4	GPO 0	Yellow
5	GPI 0	Blue
6	GND	Black
7	GND	Black
8	GND	Black

### Note:

1. Double Shielding (AL foil + copper braid)
2. Connect shielding GND wire to pin 1, 6, 7, 8

**Electrical Specification:**

		T <sub>A</sub> = 25°C		-40 TO 85°C		-40 TO 125°C		UNIT
		MIN	MAX	MIN	MAX	MIN	MAX	
V <sub>CC</sub> Supply voltage	Operating	1.65	3.6	1.65	3.6	1.65	3.6	V
	Data retention only	1.5		1.5		1.5		
V <sub>IH</sub> High-level input voltage	V <sub>CC</sub> = 1.65 V to 1.95 V	0.65 × V <sub>CC</sub>		0.65 × V <sub>CC</sub>		0.65 × V <sub>CC</sub>		V
	V <sub>CC</sub> = 2.3 V to 2.7 V	1.7		1.7		1.7		
	V <sub>CC</sub> = 2.7 V to 3.6 V	2		2		2		
V <sub>IL</sub> Low-level input voltage	V <sub>CC</sub> = 1.65 V to 1.95 V	0.35 × V <sub>CC</sub>		0.35 × V <sub>CC</sub>		0.35 × V <sub>CC</sub>		V
	V <sub>CC</sub> = 2.3 V to 2.7 V	0.7		0.7		0.7		
	V <sub>CC</sub> = 2.7 V to 3.6 V	0.8		0.8		0.8		
V <sub>I</sub> Input voltage		0	5.5	0	5.5	0	5.5	V
V <sub>O</sub> Output voltage		0	V <sub>CC</sub>	0	V <sub>CC</sub>	0	V <sub>CC</sub>	V

PARAMETER	FROM (INPUT)	TO (OUTPUT)	V <sub>CC</sub>	T <sub>A</sub> = 25°C			-40 TO 85°C		-40 TO 125°C		UNIT
				MIN	TYP	MAX	MIN	MAX	MIN	MAX	
t <sub>pd</sub>	A	Y	1.5 V	1	7	14.4	1	14.9	1	16.4	ns
			1.8 V ± 0.15 V	1	5.9	10.4	1	10.9	1	12.4	
			2.5 V ± 0.2 V	1	4.2	7.4	1	7.9	1	10	
			2.7 V	1	4.2	6.7	1	6.9	1	8.2	
			3.3 V ± 0.3 V	1.5	3.9	5.7	1.5	5.9	1.5	7.2	

**Example Circuits:**

CS203 GPIO Connection Example – Simple Circuit

GPIO port can be connected in the following way with LED, switch and resistor.

**For GPIO (Blue) and GPI1 (Red)**

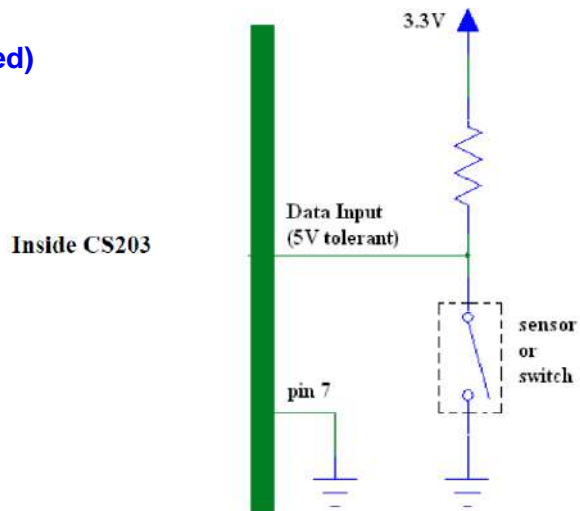

**For GPO0 (Green) and GPO1 (Yellow)**

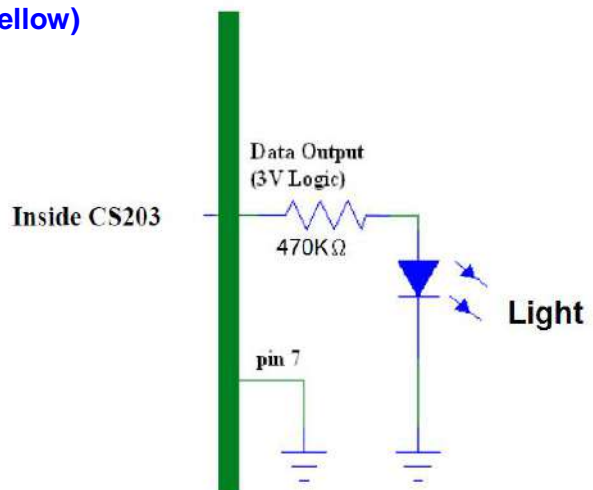

## CS203 GPIO Connection Example – Optical Coupler

GPIO port can be connected in the following way with optical couplers, switch and resistor.

For GPIO0 (Blue) and GPIO1 (Red)

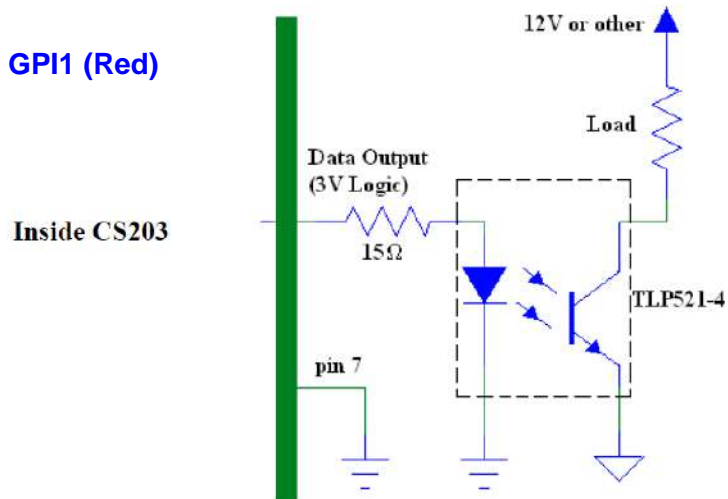

For GPO0 (Green) and GPO1 (Yellow)

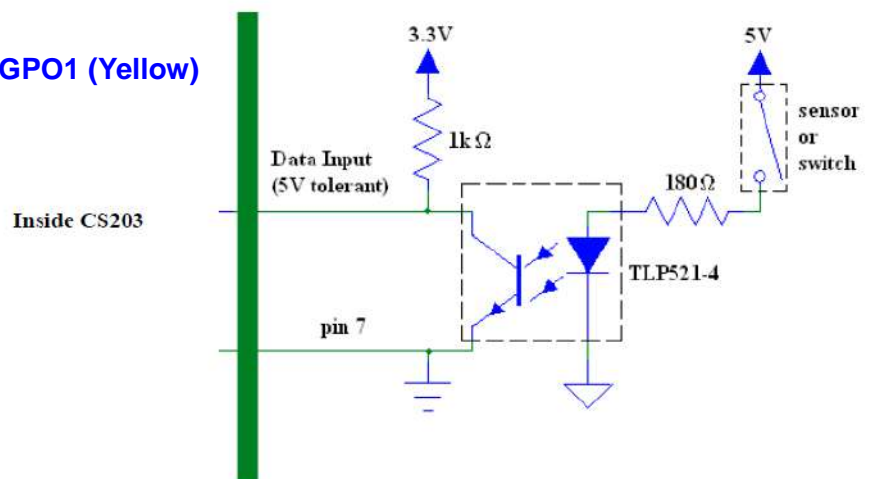

### 4.4.3 CSL GPIO Board

CSL GPIO board can be used for connecting the CS203 GPIO port to control external devices. The connection is as below. Please refer to the “CSL GPIO Board Connection Guide” for details.

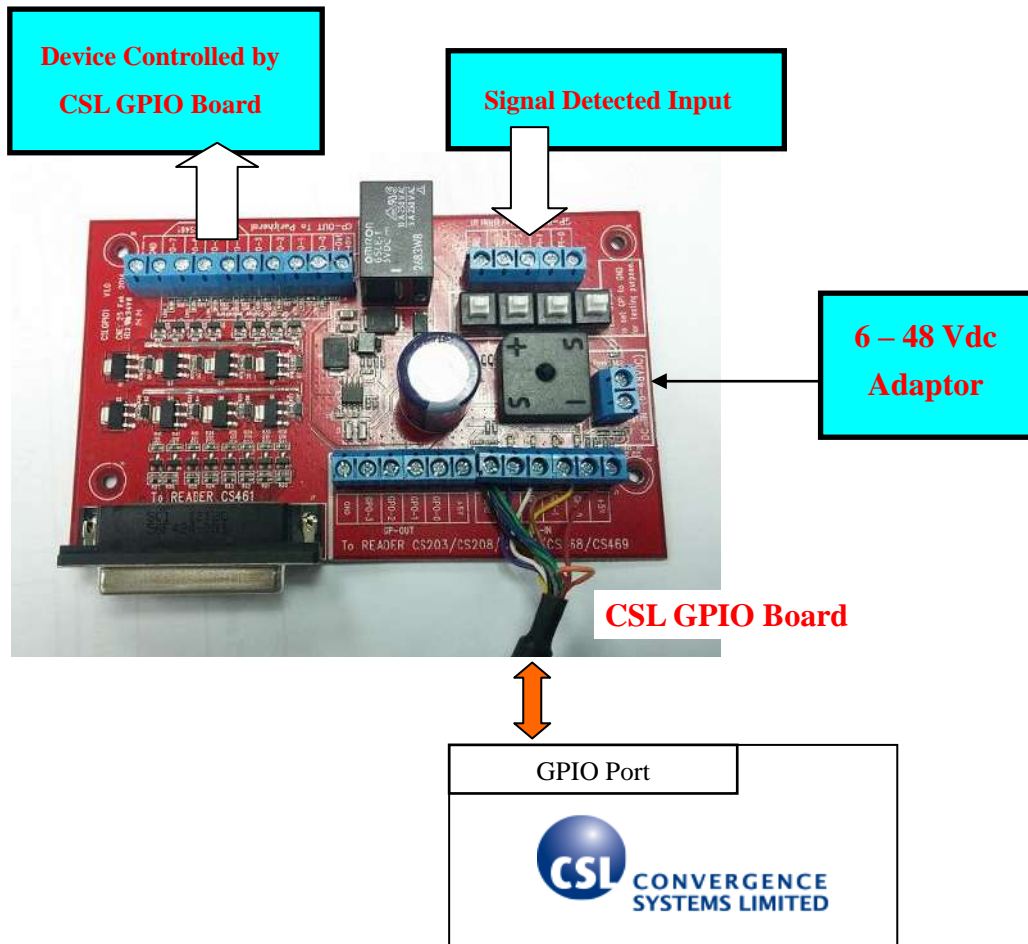

## 4.5 Reader Mechanical Mounting

The four rear mounting holes are spaced in the following manner for mechanical mounting:

$\frac{1}{4}$  x 0.625 inch studs with 20 threads/inch

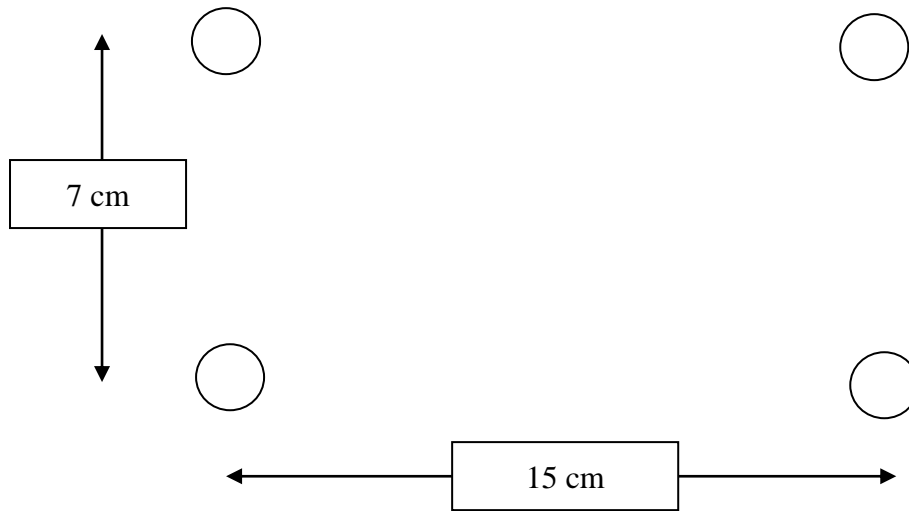



## 5 Software Installation

### 5.1 Software Content of Shipment Package

The CSL Reader software package can be downloaded from the CSL website (<http://www.convergence.com.hk>) > “Downloads & Support” area.

#### For General User

<b>1.</b>	<b>User's Manual</b>
<b>2.</b>	<b>Demo Applications (Installer)</b> <ul style="list-style-type: none"> <li>- <b>Dot Net C# (for Single and Multi-Reader), Windows OS</b></li> <li>- <b>Java (for Single and Multi-Reader), Windows OS</b></li> <li>- <b>CSL Adaptor for RifiDi Edge Server (for Multi-Reader), Windows OS</b></li> <li>- <b>C (for Multi-Reader), Linux OS</b></li> </ul>
<b>3.</b>	<b>Special Notes</b> <ul style="list-style-type: none"> <li>- <b>Ethernet Connection Problems and Handling Methods</b></li> <li>- <b>Use of Network Protocol Analyzer (Packet Sniffer) – Wireshark</b></li> <li>- <b>Use of CSL RFID Reader GPIO Control with C# Native Demo Program</b></li> <li>- <b>Set CSL RFID Reader to Bootloader Mode and Factory Default IP Configuration Setting using Hardware Reset Button</b></li> </ul>
<b>4.</b>	<b>Firmware, Upgrade Tool and Guideline</b> <ul style="list-style-type: none"> <li>- <b>Firmware Upgrade Procedure</b></li> <li>- <b>Firmware Upgrade Tool</b></li> <li>- <b>Firmware for RFID Processor</b></li> <li>- <b>Firmware for Network Processor</b></li> </ul>

**For Developer**

1.	<b>User's Manual</b>
2.	<b>Demo Applications (SDK)</b> <ul style="list-style-type: none"> <li>- <b>Dot Net C# (High Level API for Single and Multi-Reader) , Windows OS</b></li> <li>- <b>Java (Low Level API for Single and Multi-Reader) , Windows OS</b></li> <li>- <b>CSL Adaptor for Rifi di Edge Server (Low Level API for Multi-Reader), Windows OS</b></li> <li>- <b>C (Low Level API for Multi-Reader), Linux OS</b></li> </ul>
3.	<b>Reference Manual</b> <ul style="list-style-type: none"> <li>- <b>C# Unified API Reference Manual</b></li> <li>- <b>Low Level API Manual</b></li> </ul>
4.	<b>Special Notes</b> <ul style="list-style-type: none"> <li>- <b>Ethernet Connection Problems and Handling Methods</b></li> <li>- <b>Use of Network Protocol Analyzer (Packet Sniffer) – Wireshark</b></li> <li>- <b>Use of CSL RFID Reader GPIO Control with C# Native Demo Program</b></li> <li>- <b>Set CSL RFID Reader to Bootloader Mode and Factory Default IP Configuration Setting using Hardware Reset Button</b></li> </ul>
5.	<b>Firmware, Upgrade Tool and Guideline</b> <ul style="list-style-type: none"> <li>- <b>Firmware Upgrade Procedure</b></li> <li>- <b>Firmware Upgrade Tool</b></li> <li>- <b>Firmware for RFID Processor</b></li> <li>- <b>Firmware for Network Processor</b></li> </ul>

## 5.2 PC Side Prerequisites

To run the CS203 application programs, the PC must have the following software installed:

- 1) Dot Net Framework 3.5 or above

It is available in Windows 7 or above and it is downloadable from Microsoft website.

## 5.3 Default Ex-Factory IP Settings

CS203 is shipped out with the following default ex-factory IP settings:

### **Reader IP address:**

IP = 192.168.25.203

Subnet Mask = 255.255.255.0

For the first connection to it, one can use a PC or a laptop, set it to the IP address in the same subnet (e.g. 192.168.25.141 with subnet mask 255.255.255.0), then run the Demo Application that come with the CS203 package. On the applications, one can change CS203's own IP address. This is described in the next section.

## 5.4 Changing IP Address

After initial unpacking and connecting to the CS203 reader using the default ex-factory device and PC server IP address, the system integrator will need to change the IP address of the CS203 reader to the actual IP address at the site.

The IP Address of the reader can be changed using the Demo Application "**C# Native Single Reader on Windows OS with User Interface**".

## 5.5 Demo Application - "C# Native Single Reader on Windows OS with User Interface"

### 5.5.1 Hardware Setup

The only external hardware connections required by the CS203 are power and a connection to a network (Ethernet).

1. Connect the CS203 to the network with Ethernet cable.
2. Power up the CS203.
3. **If success, the "RFID" LED of the available device will be turned on.**

### 5.5.2 Software Setup

After the hardware setup, open the Demo Application "C# Native Single Reader on Windows OS with User Interface". The utility provides the following functions:

- Search for available CS203 in the network.
- Change the CS203 IP address and device name.
- Change the TCP timeout value.
- Update the CS203 Firmware (Bootloader + Application for RFID Processor and Network Processor).
- RFID operations (Inventory, Read / Write, Search, Lock, Kill, GPIO Control etc.)

**Note that you have to open the port numbers 1515 and 1516 (or turn off firewall) for reader auto-discovery function to work properly.**

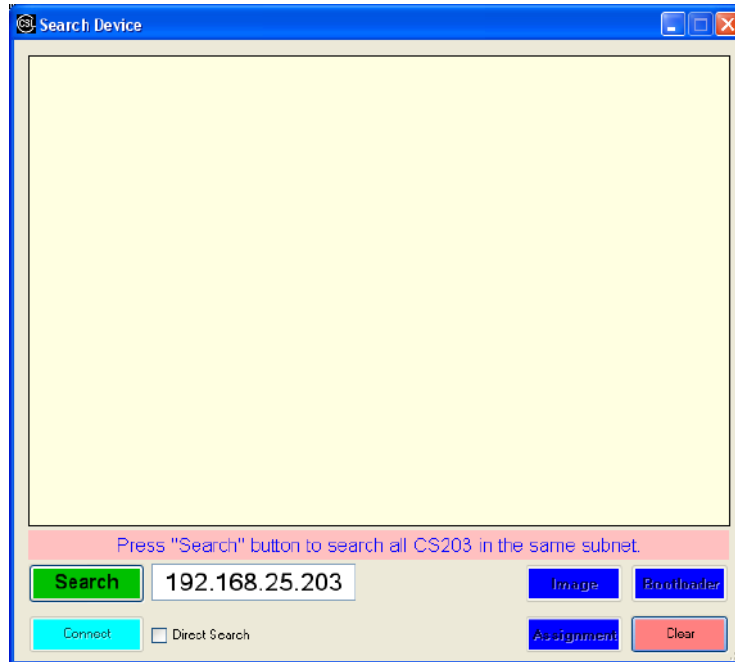

**Fig. 5-1. Demo Application - C# Native Single Reader**

### 5.5.3 Search CS203

1. Press the “Search” button.
2. Available CS203 reader on the same subnet will be listed as shown in Fig. 5-2.
3. To direct search a reader on another subnet, enter the IP address of the CS203 in the IP box, check the “Direct Search” option and click “Search” button.

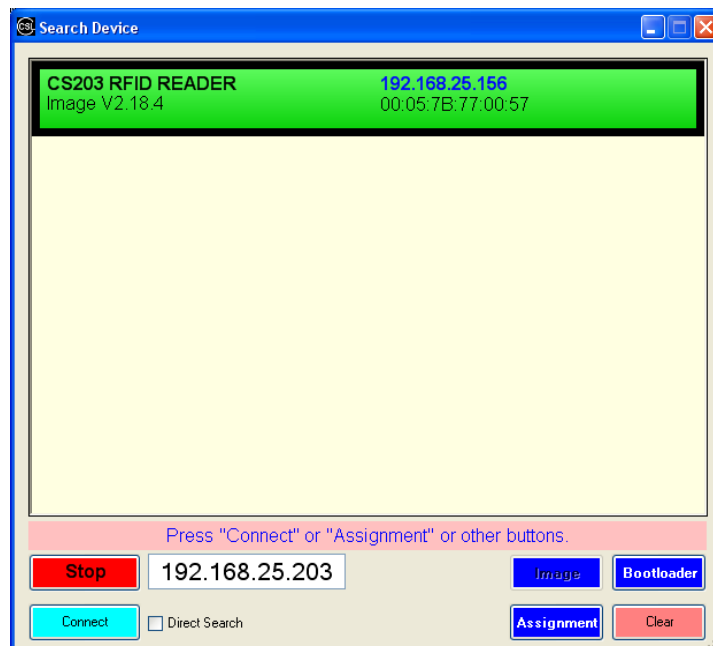

**Fig. 5-2. Searching CS203**

## 5.5.4 Assign CS203 IP and TCP Timeout

1. Select the available CS203 device. The selected one will be highlighted by a black border.
2. Press the “Assignment” button.
3. Change the CS203 device name, IP address, subnet mask, gateway and trusted server IP and press “Assign”.
4. “TrustedIP” is the IP address of the server for controlling CS203. Once this “Trusted Enable” is selected, only this trusted server can control the CS203.
5. After that, the network configuration of the device is set.

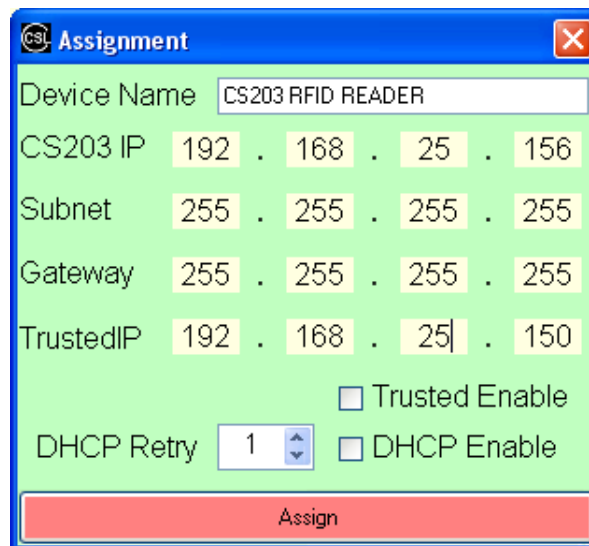

CSL Assignment

Device Name CS203 RFID READER

CS203 IP 192 . 168 . 25 . 156

Subnet 255 . 255 . 255 . 255

Gateway 255 . 255 . 255 . 255

TrustedIP 192 . 168 . 25 . 150

Trusted Enable

DHCP Retry 1  DHCP Enable

Assign

Fig. 5-3. Assign IP

## 5.5.5 Status Verification

The status of the reader, the PC software, and the network link in between should be constantly monitored. The following are the methods:

1. PC server side IP configuration: run command prompt and then run "ipconfig". Make sure the PC IP address is in the same subnet as the CS203.
2. CS203 reader side IP configuration confirmation: run command prompt and then run "ping 192.168.25.203" (or any other IP address that you have already assigned to the CS203 reader).
3. Socket status: run command prompt and then run "netstat -na"
4. Reader read tag capability: put a reference tag (tag with an ID that you know a priori) on the CS203 front face corner. Reference tag is actually an excellent idea to check the health of a reader. The backend system should monitor the presence of this ID. If this ID is seen, then the reader is still alive and well.



## 5.6 Exception Situations

The following are standard exception situations:

1. CS203 reader is turned off and on for
  1. Very short time: due to power spikes
  2. A few minutes or more, due to site maintenance or other regular site electrical operations
  
2. PC side software is turned off and on for
  1. Very short time, due to manual software application reset
  2. A few minutes or more, due to site PC OS maintenance or other regular site PC server hardware maintenance

## 5.7 Finding a "Lost" CS203

Sometimes, the operator may have changed the IP address of CS203 and then forgot what it is. In that case the user can use the auto-discovery function of the Demo Application to search for the CS203.

### 1. Hardware Setup

The only external hardware connections required by the CS203 are power and a connection to the network.

1. Connect the CS203 to a network with Ethernet cable. Please note that the weatherproof cable that comes with the CS203 shipment package is a "Crossover" cable. Thus, it can be connected to a computer directly. For connecting it to a switch/router, it depends on whether the switch/router's network port supports auto-switch to handle crossover cable (Auto-MDI/MDIX). If not, then an "Ethernet crossover adaptor" is needed.
2. Power up the CS203.

### 2. Software Setup

After the hardware setup, open the Demo App. The utility provides the following functions:

1. Search for available CS203 in the network.
2. Change the CS203 device name and IP address.
3. Change the TCP timeout value. (best set to zero)
4. Update the CS203 Boot Loader and Image to newer version.
5. RFID operations demo

**Note that you have to open the port numbers 1515 and 1516 (or turn off the firewall) for reader searching function to work properly.**

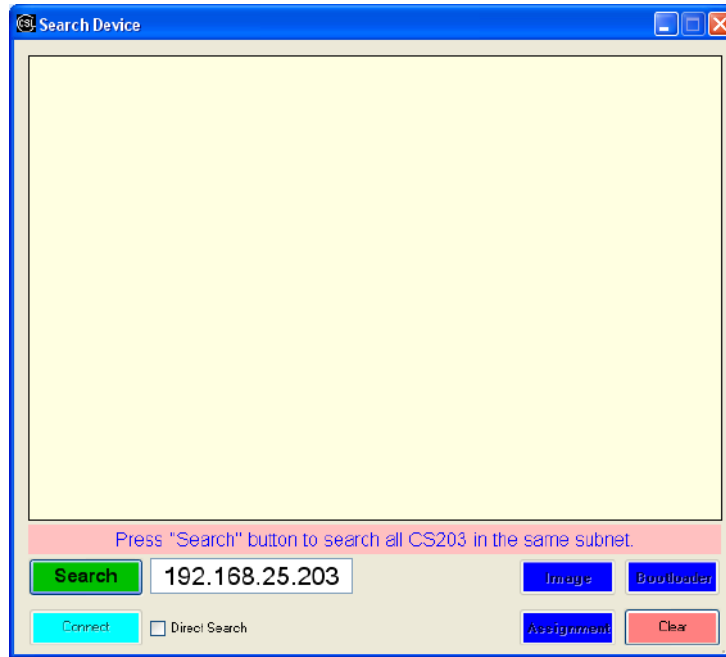

Fig. 5-4. CS203 DEMO APP

### 3. Search CS203

1. Press the “Search” button.
2. Available CS203 devices will be listed as shown in Fig. 5-6.
3. To direct search a reader on another subnet, enter the IP address of the CS203 in the IP box, check the “Direct Search” option and click “Search” button.

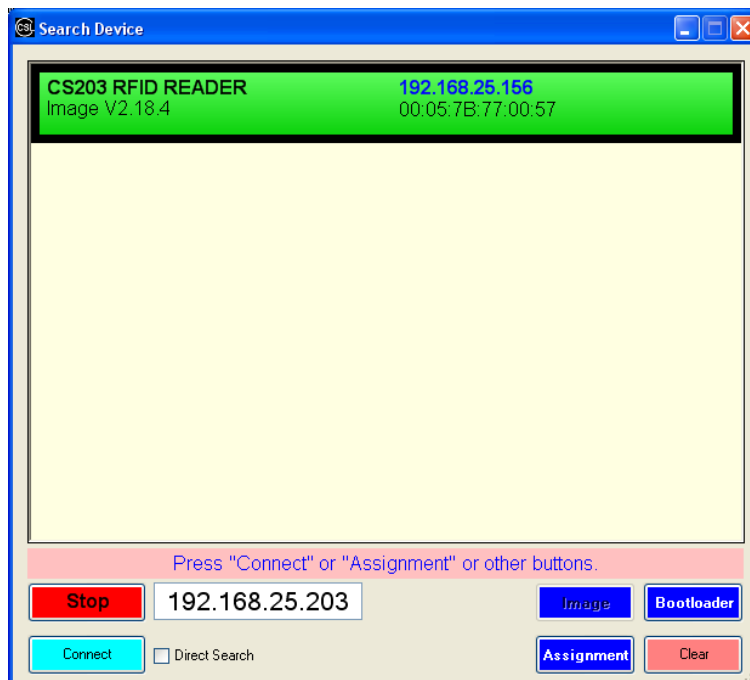

Fig. 5-5. Searching CS203

#### 4. Assign CS203 IP and TCP timeout

1. After that, you could re-assign the IP address to the reader as you want. Select the available CS203. The selected one will be highlighted by a black border.
2. Press the “Assignment” button.
3. Change the CS203 IP, subnet mask, gateway and trusted server IP and press “Assign”.
4. “TrustedIP” is the IP address of the server for controlling CS203. Once this “Trusted Enabled” is selected, only this trusted server can control the CS203.

Assignment

Device Name CS203 RFID READER

CS203 IP 192 . 168 . 25 . 156

Subnet 255 . 255 . 255 . 255

Gateway 255 . 255 . 255 . 255

TrustedIP 192 . 168 . 25 . 150

Trusted Enable

DHCP Retry 1  DHCP Enable

Assign

Fig. 5-6. Assign IP

# 6 C# Demo Application Program Operation

## 6.1 Searching for CS203 device

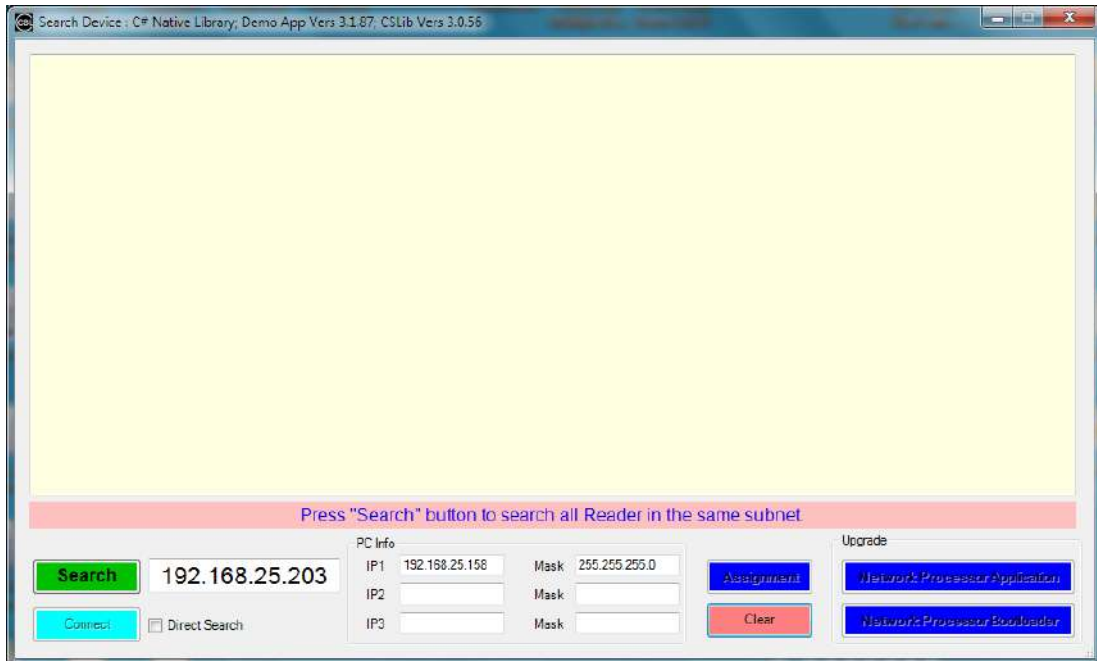

Click “Search” button to search device in the **same network**.

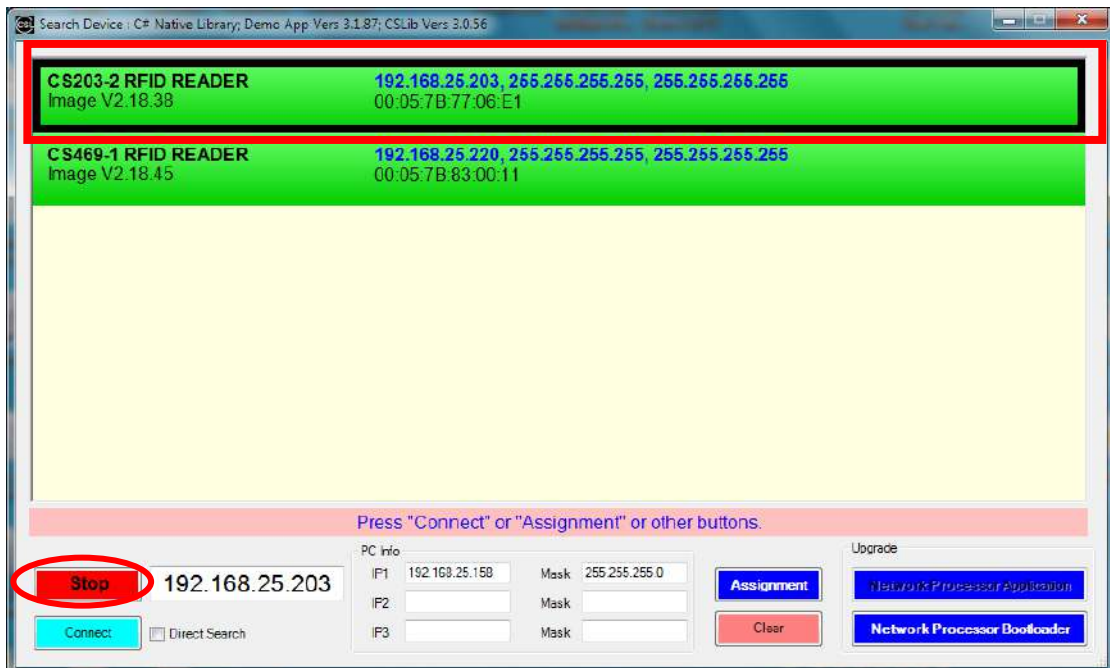

Choose specific device to connect.

If you can't find any device, please check the following:

- i. make sure the Dot Net Framework 3.5 is installed
- ii. Disable the firewall setting on the PC or network (or open the port number 1515 and 1516)
- iii. Reboot the CS203 device

## 6.2 Network Configuration of CS203

After you have found a CS203 device, you can configure the target device IP address (DHCP or static IP), Device Name and TCP timeout in "Assignment".

CSL Assignment

Device Name CS203 RFID READER

CS203 IP 192 . 168 . 25 . 156

Subnet 255 . 255 . 255 . 255

Gateway 255 . 255 . 255 . 255

TrustedIP 192 . 168 . 25 . 150

Trusted Enable

DHCP Retry 1  DHCP Enable

Assign

Note: Set TCP timeout to be zero at this moment.

### 6.3 Connecting to CS203

In order to connect to a CS203 device, select the device on the list and click the “Connect” button.

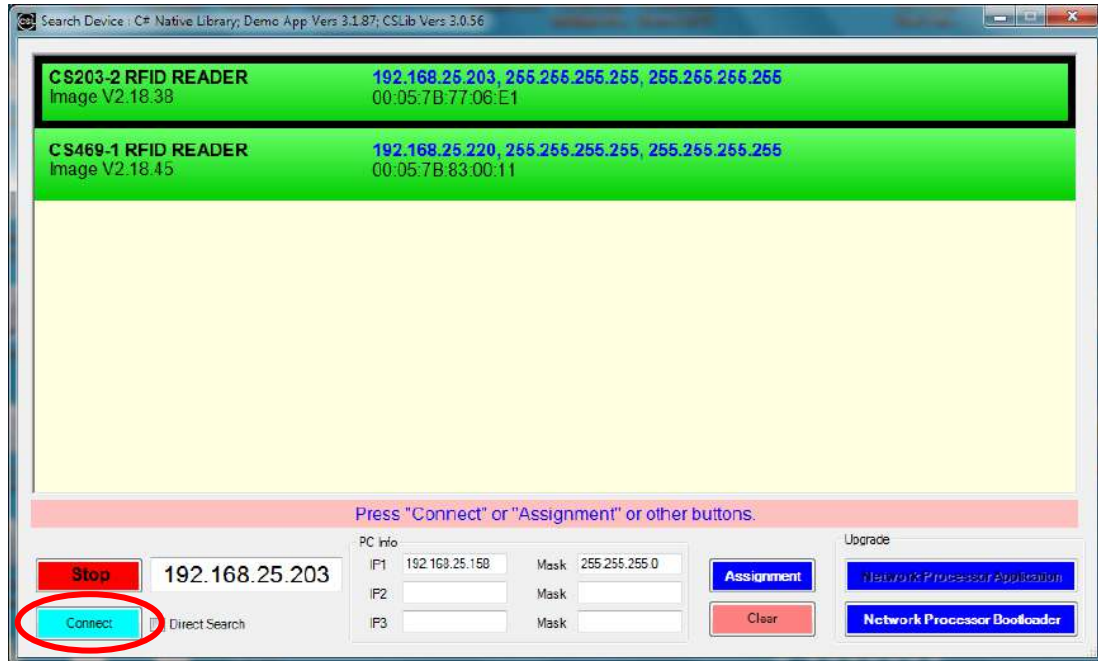

Choose a device and click “Connect” button.

## 6.4 Main Menu

In the main menu of the Demo Application program, the configuration information of the reader is shown and you can select the various functions.

Function	Configuration Details
Inventory tags	Inventory
Read and write tags	ReadWrite
Write without choose tag	WriteAny
Search Tag	Geiger
Lock Tag data	Security
Kill Tag	Kill
CS9010 Demo	CS9010
Cold Chain Demo	ColdChain
Monza 4QT Demo	Monza4QT
G2iLM Demo	G2iL/M
G2iLM Func Demo	G2iL Func
UCODE7 Demo	UCODE7
Set Hardware Com. Interface	Set Interfac
	Set API Mode
Temperature Monitoring	Temp Mon
GPIO Control (Sync)	InvGPIOSyn
GPIO Control (Async)	InvGPIOAsyn
TID Bank Demo	TID Demo
Channel Setup	Setup
Exit program	Exit

Configuration Section	Details
PC Side Version:	PC Side Version:
C# Native 3.0	C# Native 3.0
Demo App Vers 3.1.87	Demo App Vers 3.1.87
CSLib Vers 3.0.56	CSLib Vers 3.0.56
Reader Side Version:	Reader Side Version:
RFID Firmware Vers 1.5.27	RFID Firmware Vers 1.5.27
Network ProcBootLoader 2.9.03	Network ProcBootLoader 2.9.03
Network Proc: 8051 App 2.18.38	Network Proc: 8051 App 2.18.38
Frequency Profile : FCC	Frequency Profile : FCC
Frequency : Hopping	Frequency : Hopping
Profile : 2	Profile : 2
Power : 300	Power : 300
Device Type : CS203	Device Type : CS203 / CS468 / CS469
API Mode : HIGHLEVEL	API Mode communicating with Reader
Interface : IPV4	
Config File Path : C:\Users\steve.tsoi\Documents\CSLReader	Destination Path where the reader configuration is saved



## 6.5 Inventory

This page demonstrates the tag inventory functions for reading tags continuously with the RSSI value and read count.

Click the “Run” button to start reading tags.

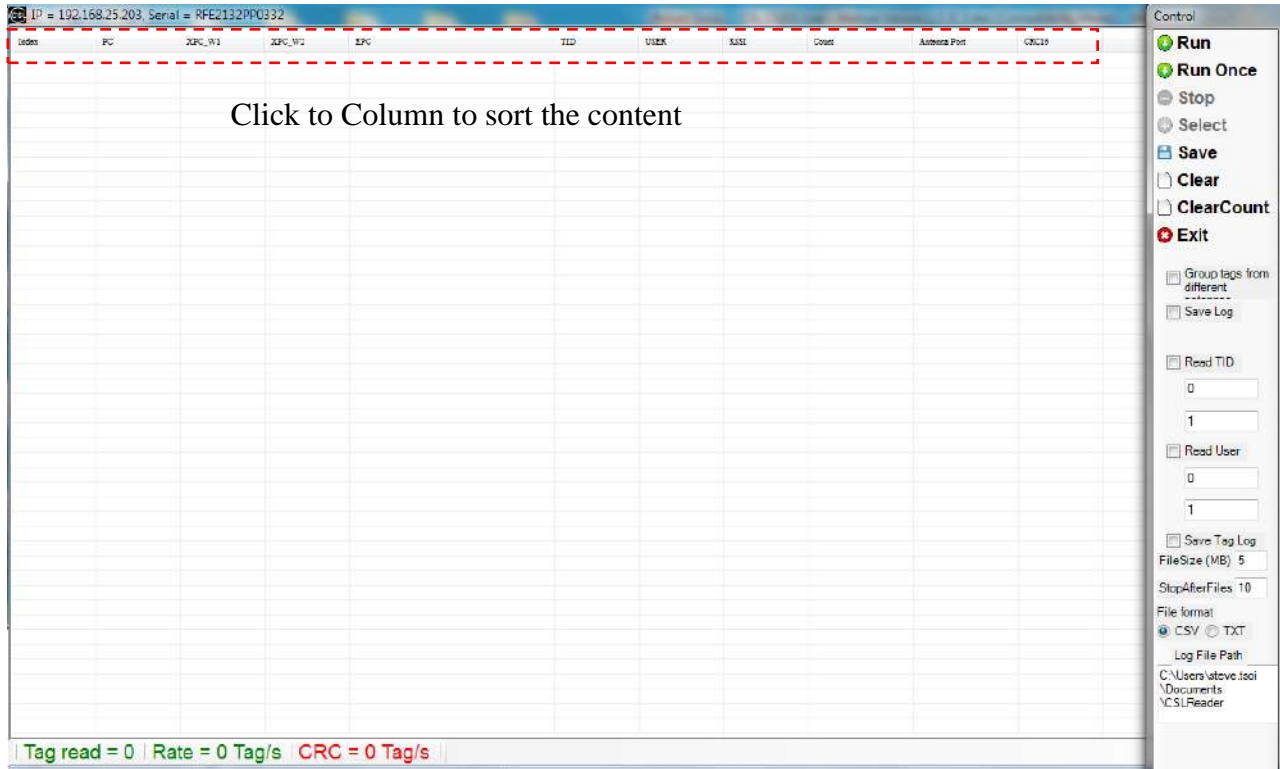

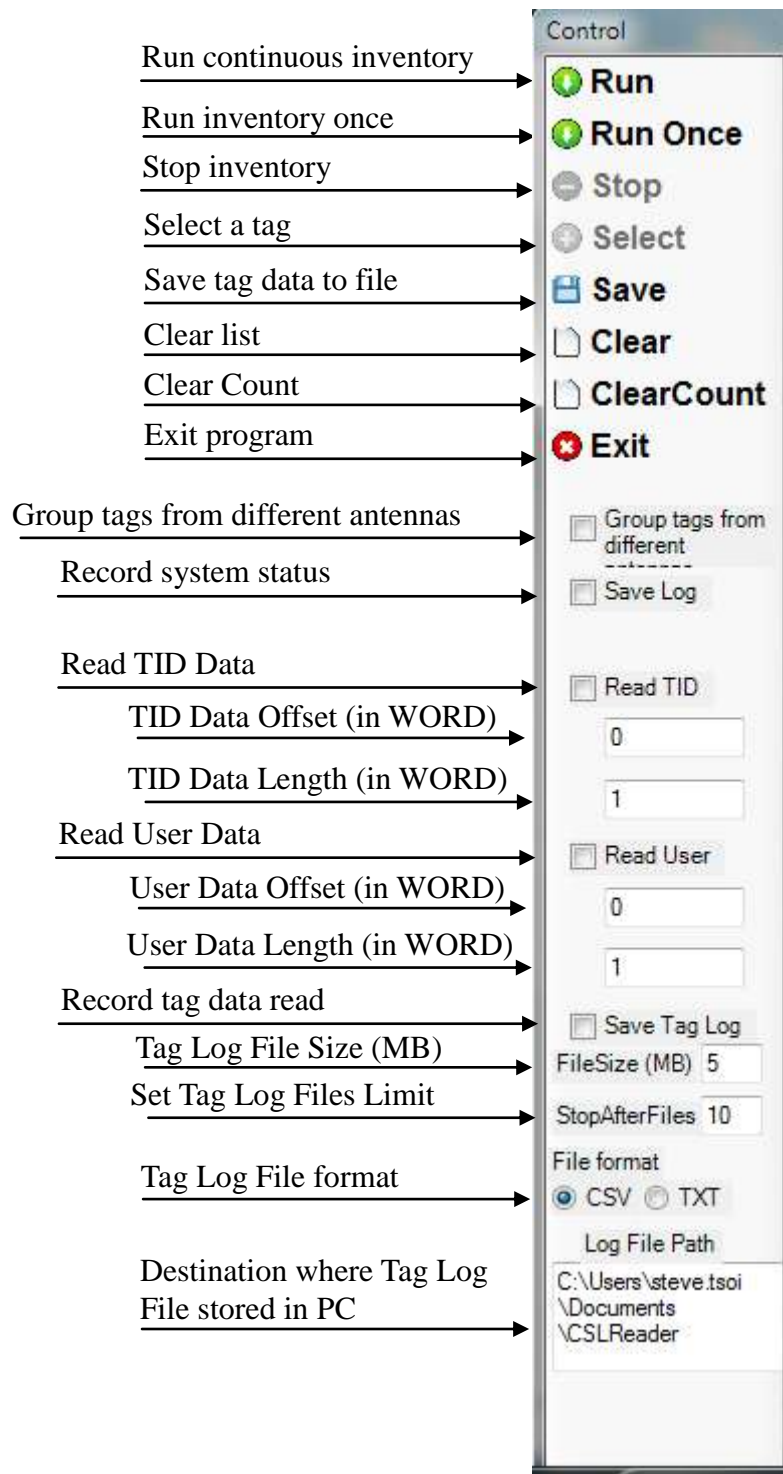

## 6.6 Read / Write

This page demonstrates the function of reading and writing different memory banks of a selected tag.

1. Click on the “Search” to scan for and select the tag you want to access.

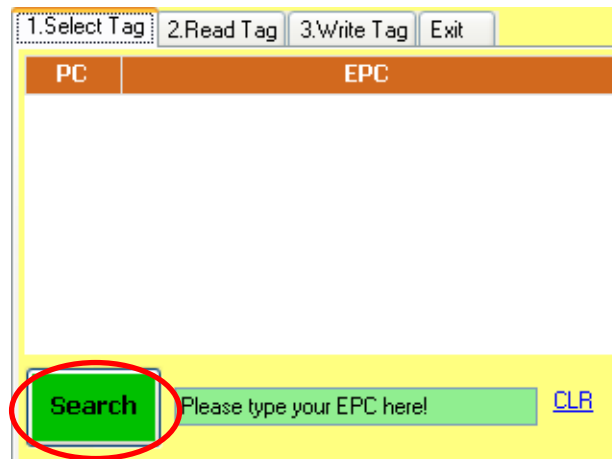

2. Select the tag on the list

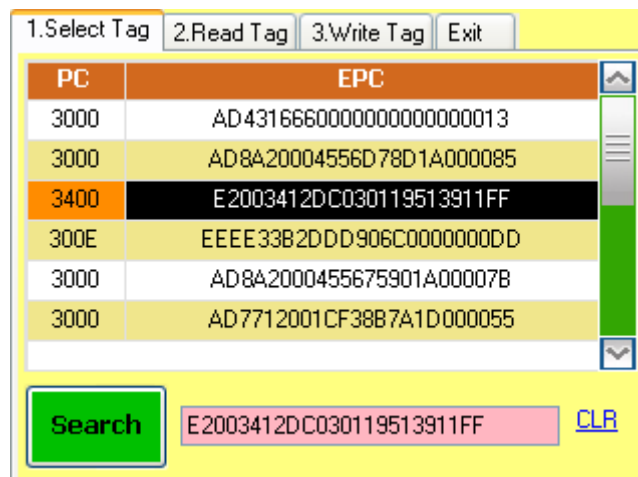

3. **Read the tag:** After the tag is selected, you can click the “2. Read Tag” tab to read the memory banks of this tag.

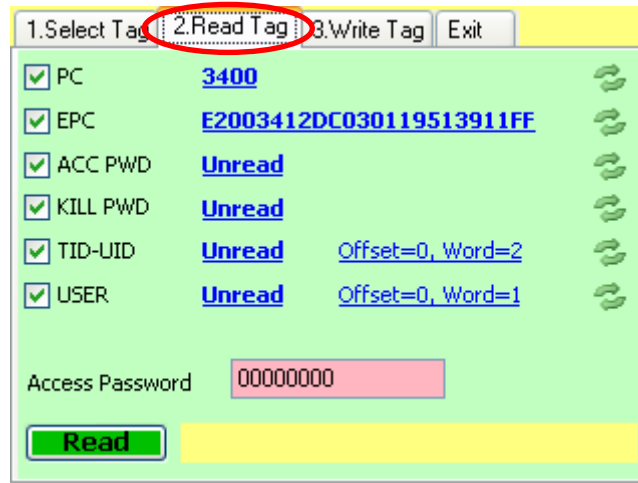

4. Click on the “Read” button to read all the memory banks.

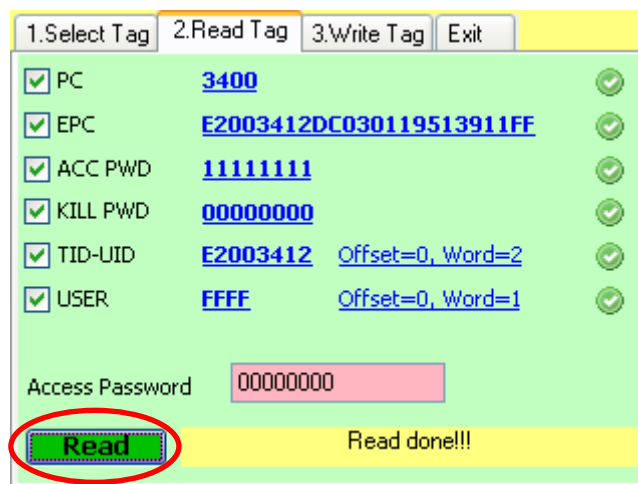

- 5. For the “TID-UID” and “User Memory” banks, you could also change the offset word and length of words you want to read. Click on the red lines and change values. After entering the “Offset” and “Cnt” (in terms of words), click the “Read” button to read the tag.

1.Select Tag 2.Read Tag 3.Write Tag Exit

- PC 3400
- EPC E2003412DC030119513911FF
- ACC PWD 11111111
- KILL PWD 00000000
- TID-UID E2003412 [Offset=0, Word=2](#)
- USER FFFF [Offset=0, Word=1](#)

Access Password 00000000

Read Read done!!!

Configuration

Offset 0

Word 32

OK Cancel

If the length of the user memory read is too long to be displayed on screen, click on the data and it will expand to display all the data.

1.Select Tag 2.Read Tag 3.Write Tag Exit

- PC 3400
- EPC E2003412DC030119513911FF
- ACC PWD 11111111
- KILL PWD 00000000
- TID-UID E2003412 [Offset=0, Word=2](#)
- USER FFFF0000 [Offset=0, Word=32](#)

Access Password 00000000

Read Read done!!!

1.Select Tag 2.Read Tag 3.Write Tag Exit

FFFF00000000000022222220000000000000  
 00  
 00  
 00

Access Password 00000000 [Hide](#)

Read Read done!!!

If the memory bank is locked, input the access password in “Access Password” field to read the tag data.

- Write the tag:** Click on the “3.Write Tag” tab on the top to write data on the selected tag memory banks.

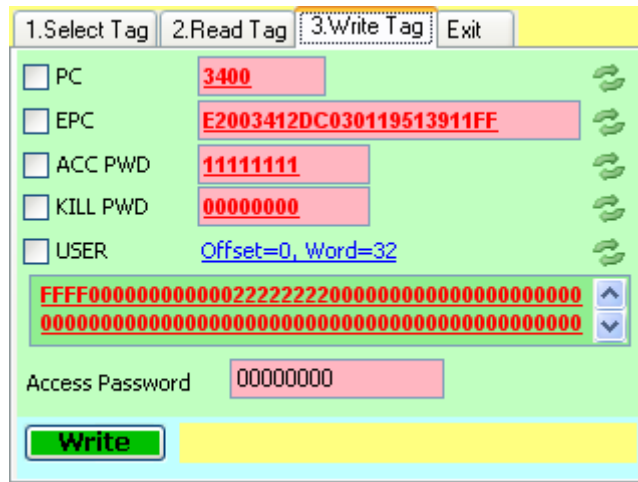

- Tick the checkbox(es) of the memory bank(s) you want to write. Input the new data of that field(s) and then click the “Write” button to write the new data.

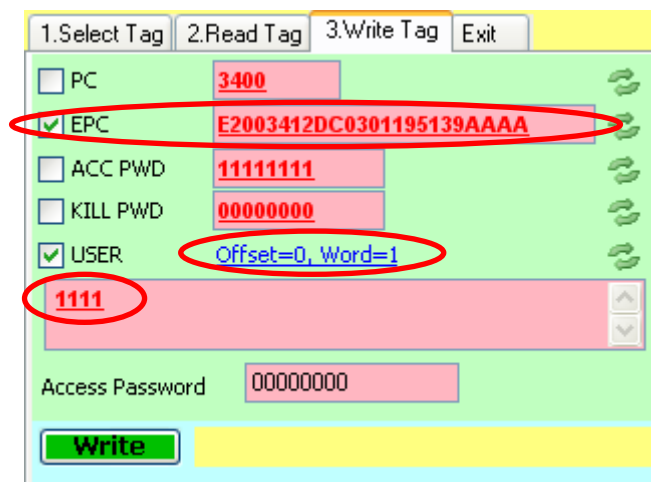

If the memory bank is locked, input the access password in “Access Password” field to write the tag.

8. **Exit Read/Write:** To exit this Read / Write function, click the “Exit” tab.

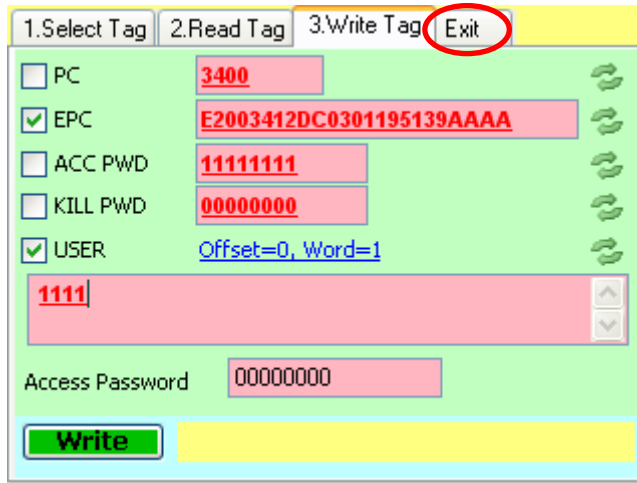

## 6.7 Write Any

This page demonstrates how to write multiple tags EPC ID with automatic increment.

The screenshot shows the 'Write EPC auto increment' interface with the following fields and callouts:

- num of Tags:** 1 (Callout: Total number of tags to write)
- Initial Value(decimal):** 0 (Callout: The starting value to write)
- Input Mask:** (Callout: EPC Mask)
- Output Mask:** (Callout: EPC Mask)
- Fix Q Value:** 0 (Callout: Input Fix Q Value)
- Process Retry:** 0 (Callout: Retry Write EPC Process)
- Write Retry:** 2 (Callout: Retry Write EPC for the tag)
- Toggle A/B:**  (Callout: Enable Toggle A/B)
- Match Mask:**  (Callout: Write EPC with Match / Non Match Mask)
- Non Match Mask:**  (Callout: Write EPC with Match / Non Match Mask)
- Successful Written Tag:** 0 (Callout: Number of tags successfully written)
- Buttons:** Start, Stop, Exit

For example, you would like to write 100 tags with EPC ID starting from ABCD01234567890123456701. The parameters should be as follows:

Num of Tag = 100

Initial Value (decimal) = 1

Mask = ABCD012345678901234567XX (because it needs 2 Hex digits for total 100 numbers)

Then, you should input as below and click the “Start” button to start writing.

The screenshot shows the 'Write EPC auto increment' interface with the following fields:

- num of Tags:** 1
- Initial Value(decimal):** 0
- Input Mask:** (Empty)
- Output Mask:** ABCD012345678901234567
- Fix Q Value:** 0
- Process Retry:** 0
- Write Retry:** 2
- Toggle A/B:**
- Match Mask:**
- Non Match Mask:**
- Successful Written Tag:** 0
- Buttons:** Start, Stop, Exit



## 6.8 Geiger Counter Search

This page demonstrates the Geiger counter tag search mode. Search or Input the EPC ID of the tag (or partial of the EPC ID) you want to search and then click the “Start” button.

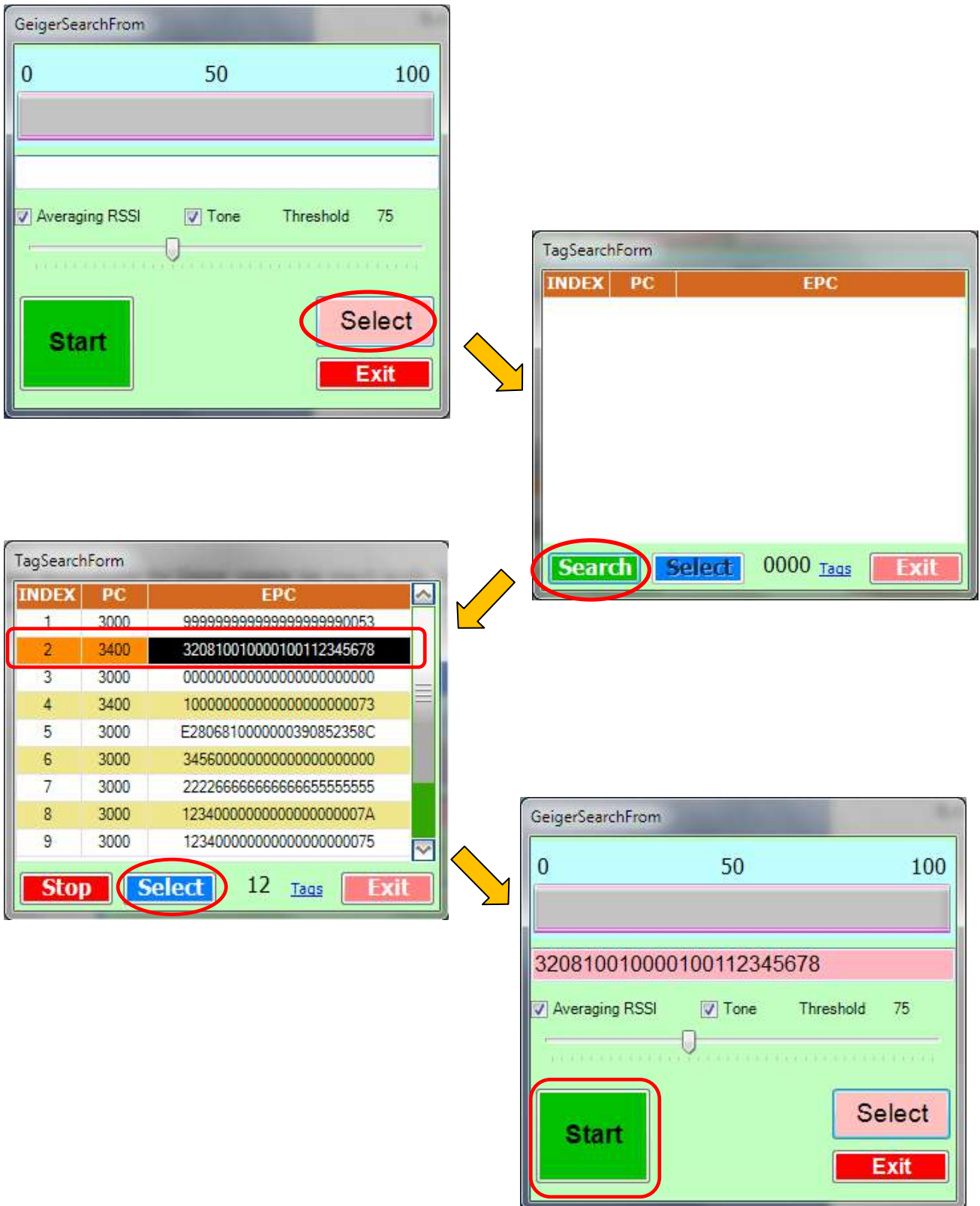

When the tag is seen, it shows the RSSI value.



## 6.9 Tag Security

This page demonstrates the tag security operations (lock, unlock and kill)

Click *“Please Click Here To Select A Tag”* to scan for the tag.

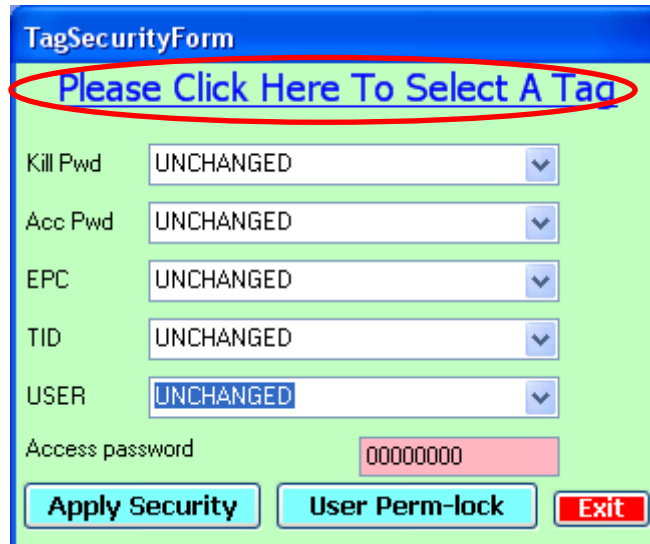

Highlight and select the tag you want to access in the list.

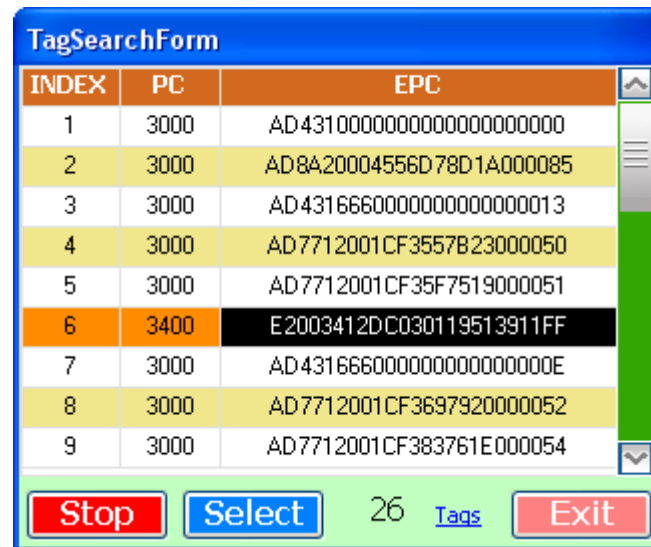

After the tag is selected, select the security you want to apply on each memory bank.

For Kill Password (Kill Pwd) and Access Password (Acc Pwd) banks:

- UNLOCK: Unlock the bank – allow user to read and write it without access password
- PERM\_UNLOCK: Permanently unlock the bank – allow user to read and write it forever without access password (cannot lock it again)
- LOCK: Lock the bank – cannot read and write the tag, need access password to unlock it
- PERM\_LOCK: Permanently lock the bank – cannot read and write the tag forever (cannot unlock it again)
- UNCHANGED: Keep the existing security state

For EPC and User Memory (USER) banks:

- UNLOCK: Unlock the bank – allow user to write it without access password
- PERM\_UNLOCK: Permanently unlock the bank – allow user to write it forever without access password (cannot lock it again)
- LOCK: Lock the bank – cannot write the tag, need access password to unlock it
- PERM\_LOCK: Permanently lock the bank – cannot write the tag forever (cannot unlock it again)
- UNCHANGED: Keep the existing security state

After the security state is selected, enter the access password in “Access Password” field. If the access password field of the tag is “00000000”, that means no password is set on the tag and it could not be locked. Please write the access password on the tag in “Read/Write” function first.

The screenshot shows the 'TagSecurityForm' window with the following fields and values:

- Tag ID: E2003412DC030119513911FF
- Kill Pwd: UNCHANGED
- Acc Pwd: UNCHANGED
- EPC: LOCK (highlighted with a red oval)
- TID: UNCHANGED
- USER: UNCHANGED
- Access password: 11111111 (highlighted with a red oval)

Buttons at the bottom: Apply Security, User Perm-lock (highlighted with a red oval), and Exit.

Click the “Apply Security” button to set the security on the tag’s memory bank(s).

## 6.10 User Perm-lock

The screenshot shows the 'TagSecurityForm' window with the following fields and values:

- Tag ID: Please Click Here To Select A Tag
- Kill Pwd: UNCHANGED
- Acc Pwd: UNCHANGED
- EPC: UNCHANGED
- TID: UNCHANGED
- USER: UNCHANGED
- Access password: 00000000 (highlighted with a red oval)

Buttons at the bottom: Apply Security, User Perm-lock (highlighted with a red oval), and Exit.

In Tag Security, the “User Perm-lock” function is used for block-level (64 bits) Perma-lock of tag’s user memory. This function is only applicable for new tag that complies to the EPC Class 1 Gen 2 Tag Specification v1.2 (e.g. Alien Higgs3). Moreover, this function is **only support on CS203 with firmware version 1.3.68 or above.**

To perma-lock the 64-bits block of user memory:

- 1) Click "User Perm-lock" button to enter the block perm-lock page.
- 2) Click "Please click here to select a tag" to scan and select the tag you want to lock

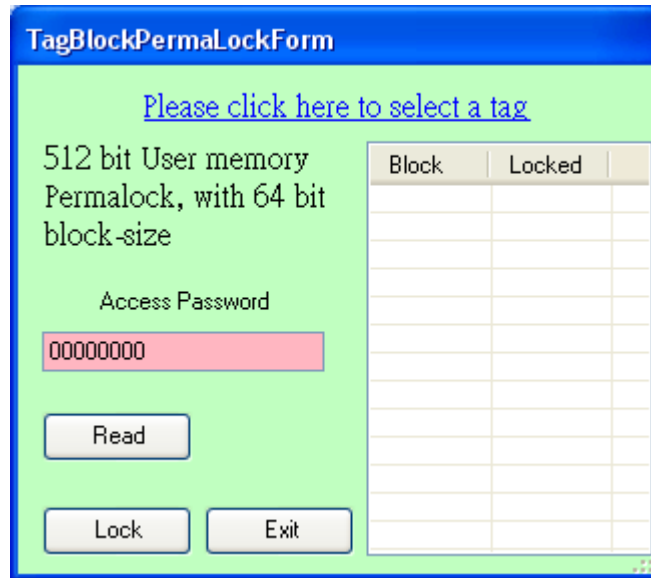

- 3) Enter the correct Access Password of the tag

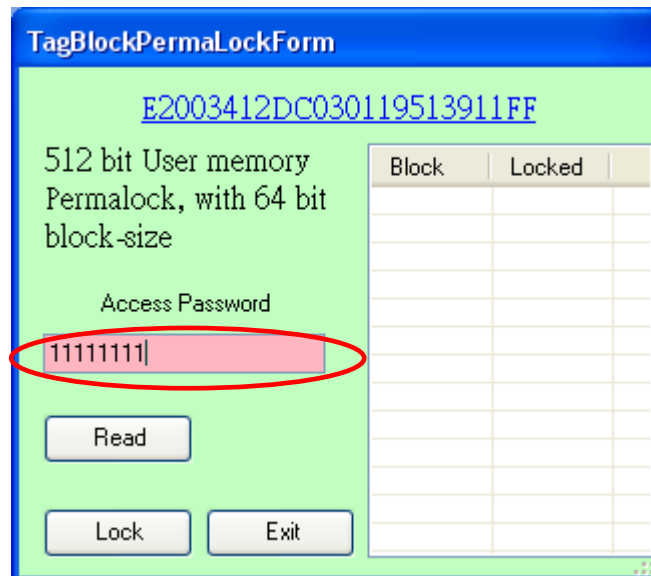

- 4) Click “Read” button to read the status of each block (64 bits) of the user memory

The screenshot shows the 'TagBlockPermaLockForm' window. At the top, the tag ID 'E2003412DC030119513911FF' is displayed. Below it, the text reads '512 bit User memory Permalock, with 64 bit block-size'. An 'Access Password' field contains '11111111'. A table on the right shows the lock status for blocks 0 through 7. The 'Read' button is circled in red.

Block	Locked
0	Locked
1	Unlocked
2	Unlocked
3	Unlocked
4	Locked
5	Unlocked
6	Unlocked
7	Locked

- 5) In order to change the lock status of a block, “Right-click” the block(s) you want to lock for changing the lock status and then select “PermaLock”.

The screenshot shows the 'TagBlockPermaLockForm' window. The 'Access Password' field still contains '11111111'. In the table, block 1 is highlighted with a blue background, indicating it has been selected for a right-click operation.

Block	Locked
0	Locked
1	Locked
2	Unlocked
3	Unlocked
4	Locked
5	Unlocked
6	Unlocked
7	Locked

- 6) Make sure the correct Access Password is entered and then click “Lock” button to perma-lock the block(s)
- 7) The blocks permalock status will be changed. Note that it is “Permanent Lock” on the block(s), it cannot be unlock again.

## 6.11 Kill

This page demonstrates the Kill Tag operation.

Click “*Click here to select a tag to destroy*” to scan and select the tag



The screenshot shows a window titled "TagKillForm" with a light green background. At the top, there is a blue header bar with the text "TagKillForm". Below the header, there is a red oval around a blue hyperlink that says "Click here to select a tag to destroy". Below this is a red warning box with the text "Warning : Tag will be destroyed permanently." in blue. Underneath the warning, there is a text input field labeled "Kill password:" containing the value "00000000". Below that is a dropdown menu labeled "ExtCommand" with "Tag Kill" selected. At the bottom left is a green button labeled "Kill Tag", and at the bottom right is a pink button labeled "Exit".

After the tag is selected, enter the kill password of the tag as below. If the kill password of the tag is set as “00000000”, that means no password is set on the tag and it could not be killed. Please write the password on the tag in “Read/Write” function first.



The screenshot shows the same "TagKillForm" window. The "Kill password:" field now contains the value "22222222", which is circled in red. The "ExtCommand" dropdown menu still shows "Tag Kill". The "Kill Tag" and "Exit" buttons remain at the bottom.

After that, click the “Kill Tag” button to kill the tag.

## 6.12 Setup

Please refer to **Section 7 “Reader Configuration”** about Reader Setup in detail.

## 6.13 GPIO Control

1. Power on CSL RFID Reader, CSL GPIO Board.
2. Run CSL C# Native Demo Program.
3. Choose “InvGPIO Syn”.

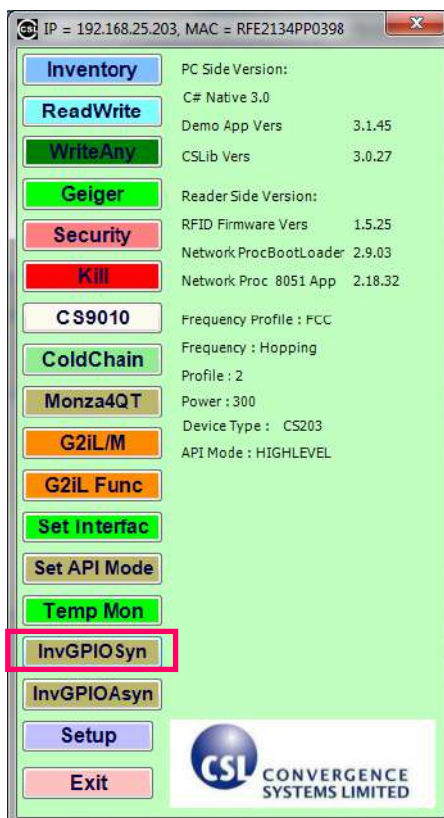



4. Click **"GPO0 On"**. The Green LED of GPO-0 turns ON.

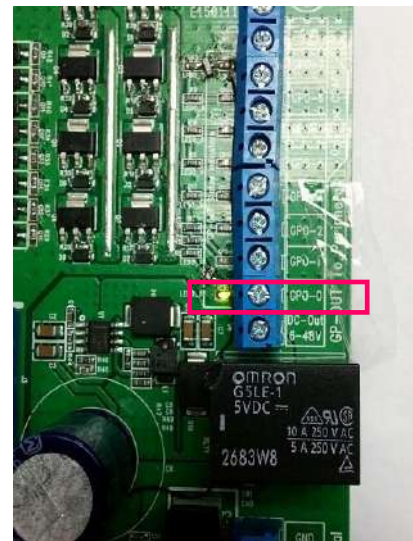
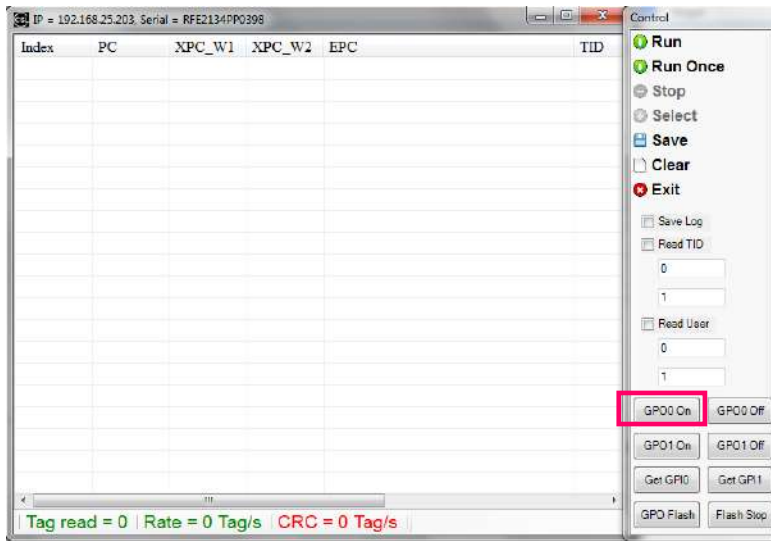

5. Click **"GPO0 Off"**. The Green LED of GPO-0 turns OFF.

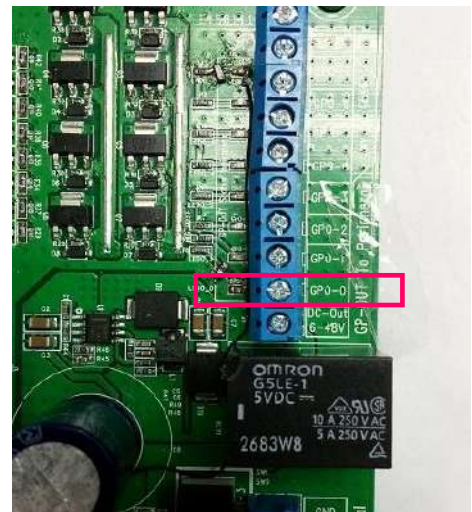
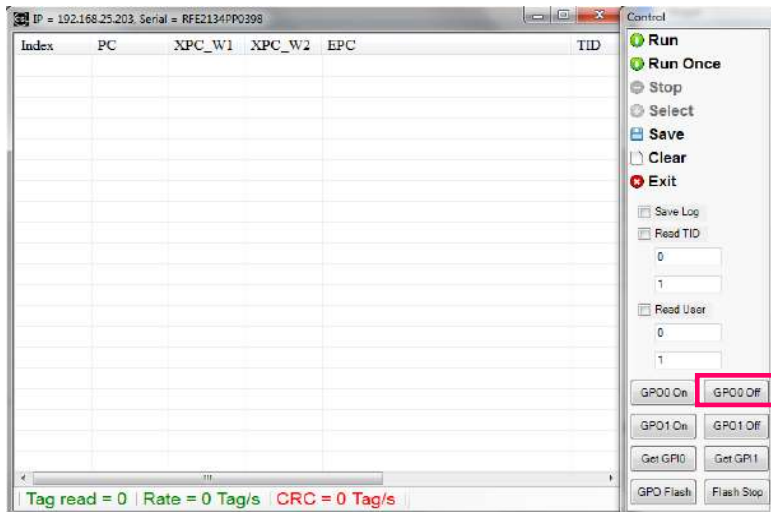

6. Click **"GPO1 On"**. The Green LED of GPO-1 turns ON.

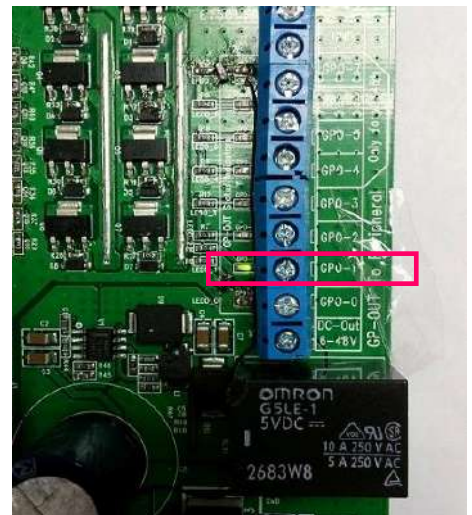
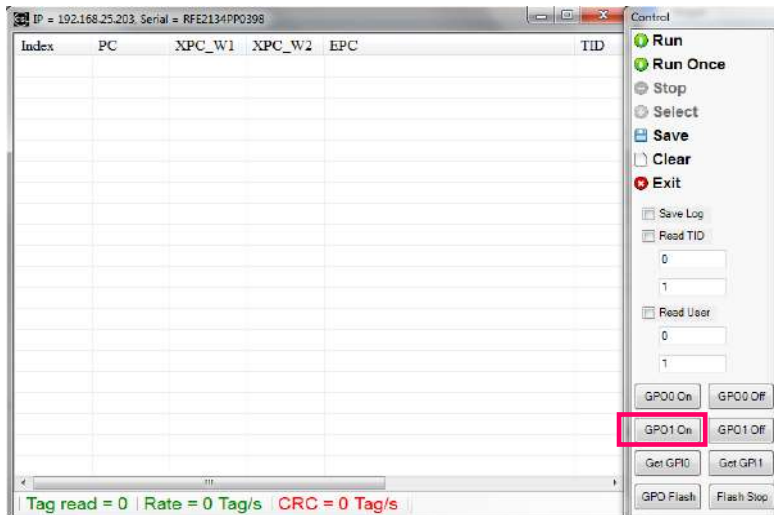

7. Click **"GPO1 Off"**. The Green LED of GPO-1 turns OFF

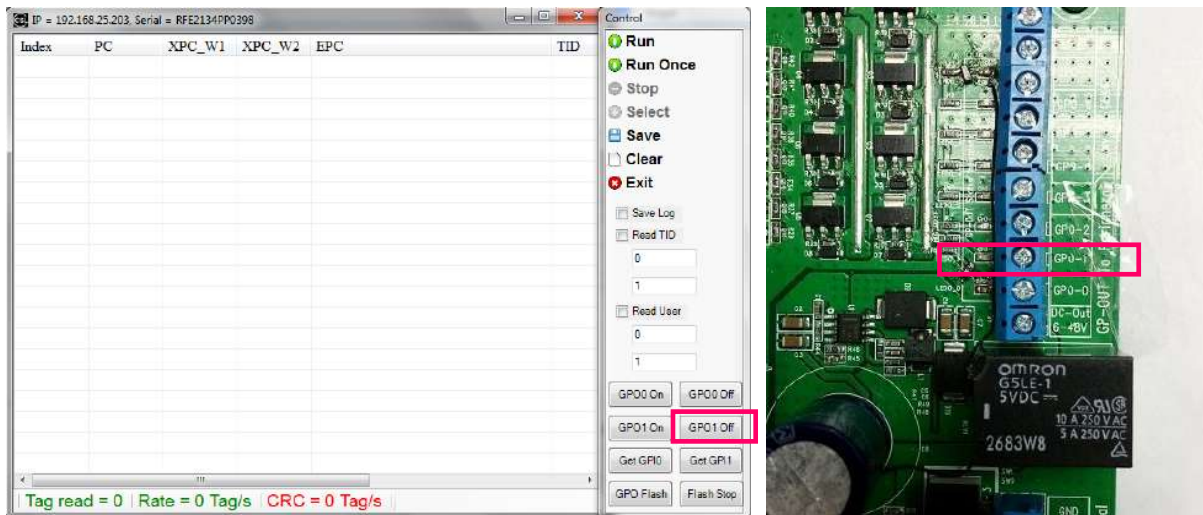

8. Press and Hold the Switch **GPI-0**. Click **"Get GPIO"**. It reports the GPIO Status is set to

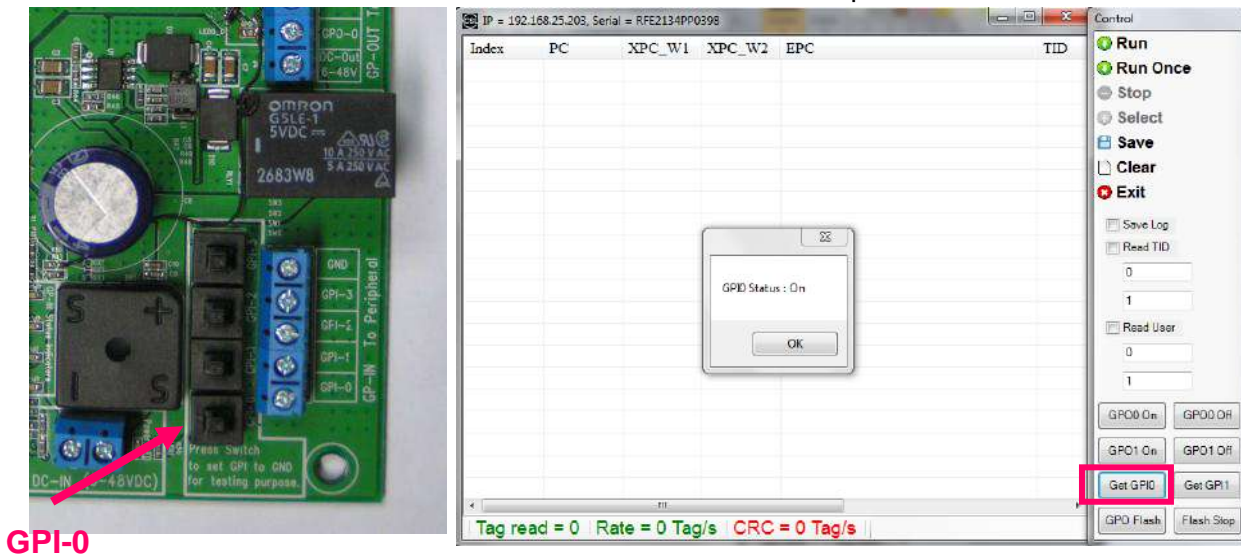

**GPI-0**

9. Release the Switch **GPI-0**. Click **"Get GPIO"**. It reports the GPIO Status is set to Off

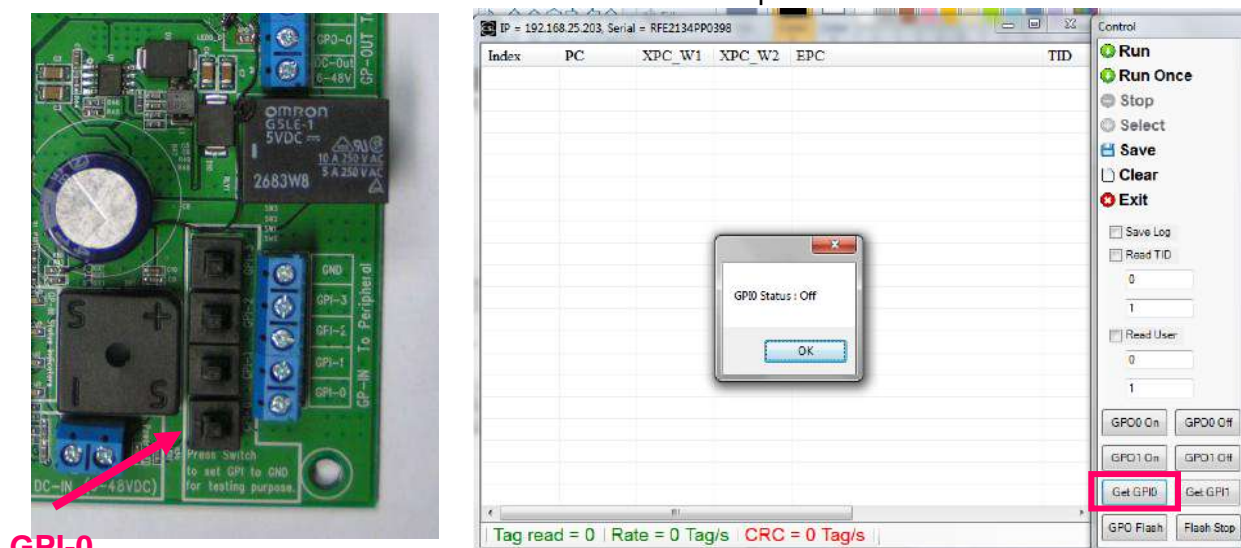

**GPI-0**

10. Press and Hold the Switch **GPI-1**. Click **“Get GPI”**. It reports the GPI0 Status is set to On

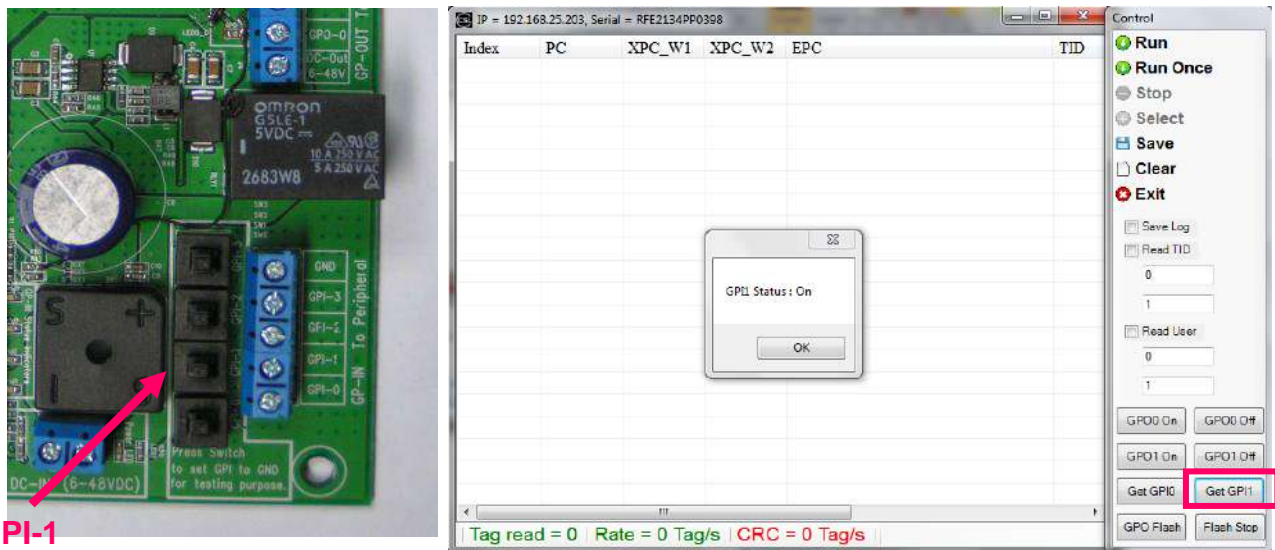

GPI-1

11. Release the Switch **GPI-1**. Click **“Get GPI”**. It reports the GPI1 Status is set to Off

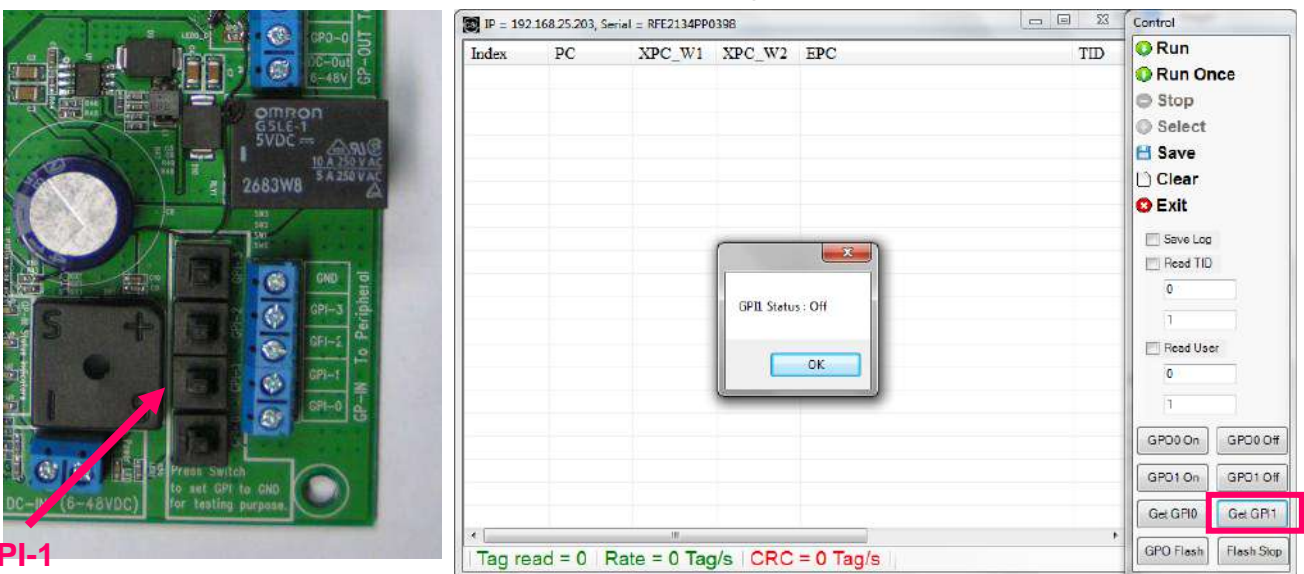

GPI-1

12. Click “GPO Flash” and click “Run”. The Green LED of GPO-0, GPO-1 will flash during inventory run.

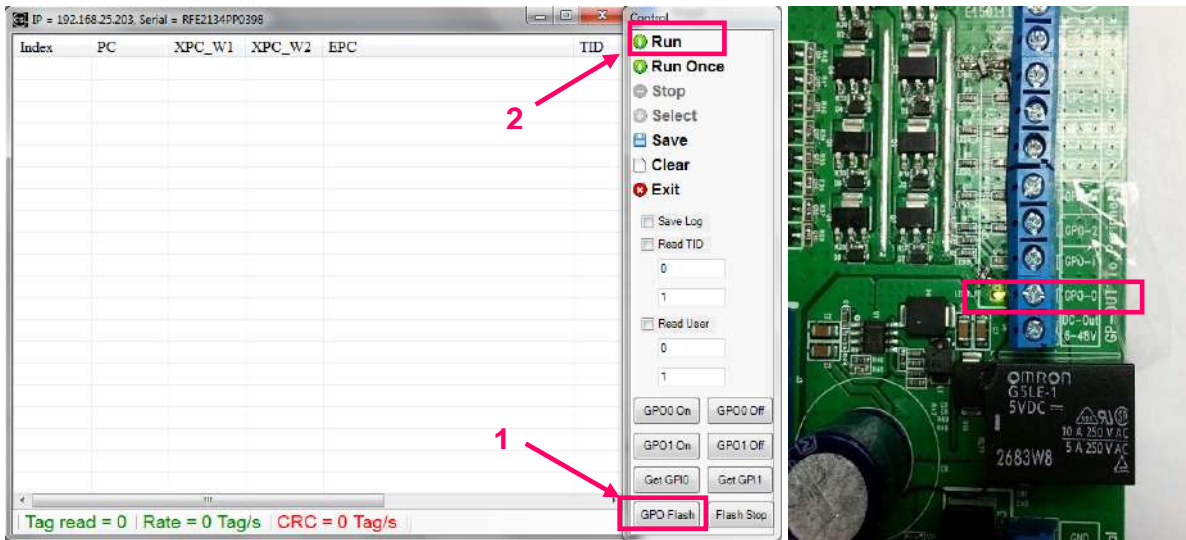

13. Click “Flash Stop” during inventory run. The Green LED of GPO-0, GPO-1 will stop flashing.

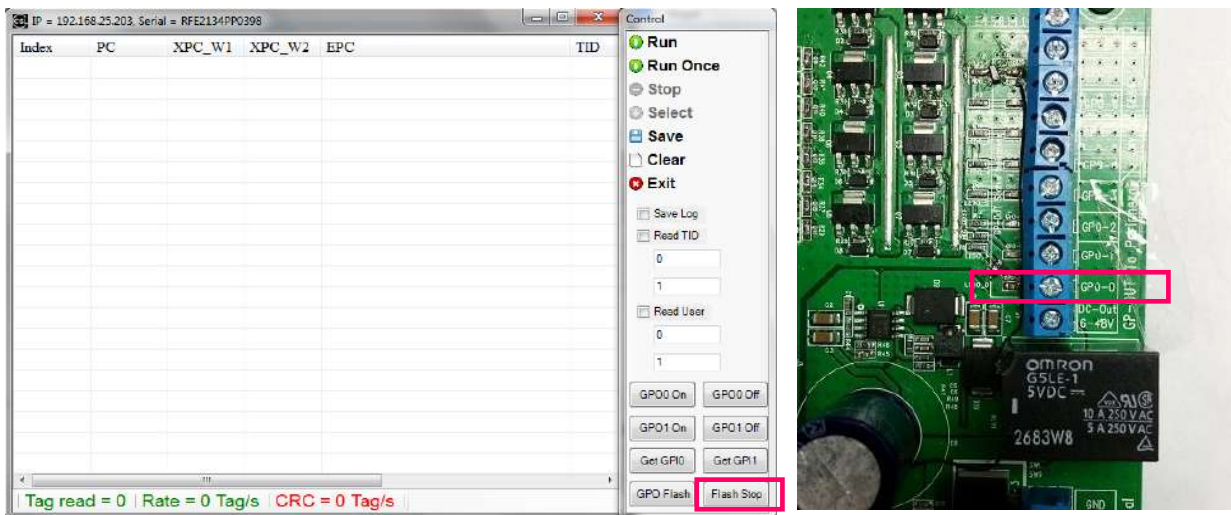

## 6.14 Middleware Connectivity

The CS203 is connected to many middleware, and the list of compatibility will continuously keep growing. Currently there are 2 middleware already connected:

1. Sybase iAnywhere
2. Microsoft Biztalk

# 7 Reader Configuration

## 7.1 Reader Configuration Overview

The diagram below shows the configuration components of CSL RFID reader CS203 / CS468 / CS469.

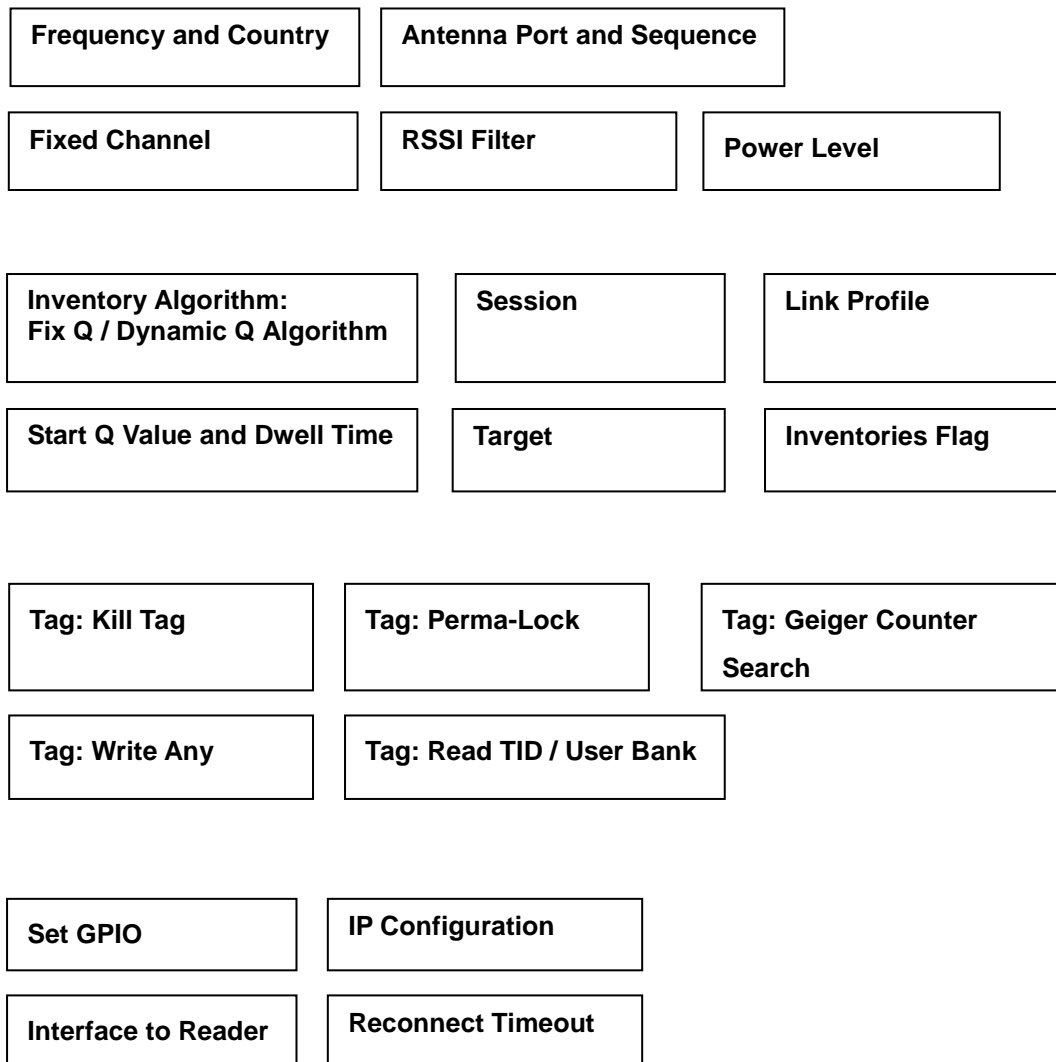

## 7.2 IP configuration (C# and Java Demo App)

After a CSL RFID reader is found, you can configure the target device IP address (DHCP or static IP), Device Name and TCP timeout in “Assignment” using both C# and Java Demo App.

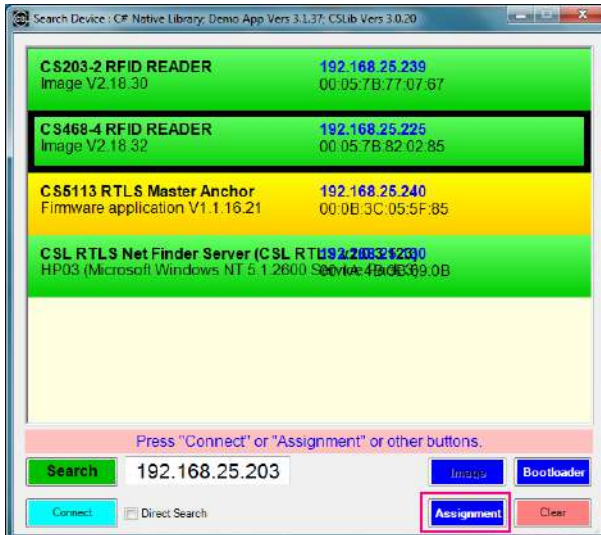

C# Demo App

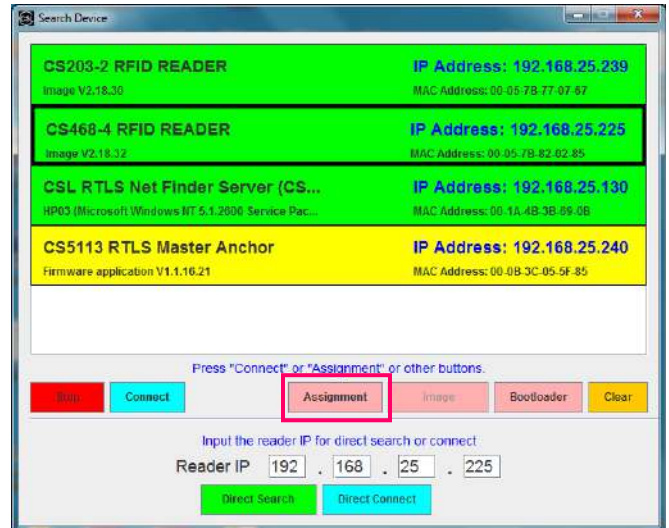

Java Demo App

If you want the reader to get an IP address assigned from DHCP server, tick the “DHCP Enable” checkbox, input the DHCP retry value and click the “Assign” button.

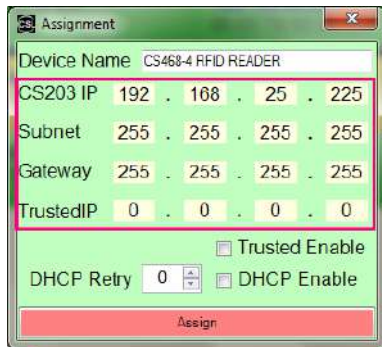

C# Demo App

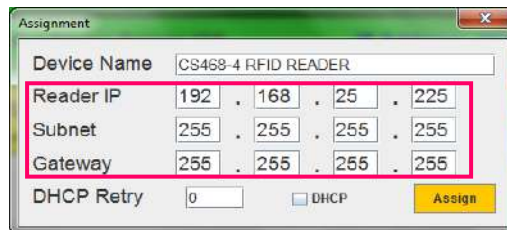

Java Demo App

C# Demo App also provides a “Trusted Server” feature that only a specific device can connect to the CSL RFID reader. To enable this feature, tick the “Trusted Enable” checkbox and input the IP address of the computer/device in “TrustedIP” boxes, and then click “Assign” button. Then, only the computer with the IP address in the “TrustedIP” box is allowed to connect with this reader.

### 7.3 Reconnect Timeout (C# Demo App)

After a CSL RFID lost connection, CSL Demo App can reconnect to the RFID Reader within a time. In *Java Demo App*, the default Reconnect timeout is 5 seconds.

In *C# Demo App*, to setup the timeout for reconnection, press **“Setup”** button in the Main Menu.



C# Demo App

In the window **“Setup”**, choose **“General Options”**. In the field **“Reconnect Timeout”** user can set the Reconnect timeout in ms (default value is 30000, which is equal to 30 seconds).

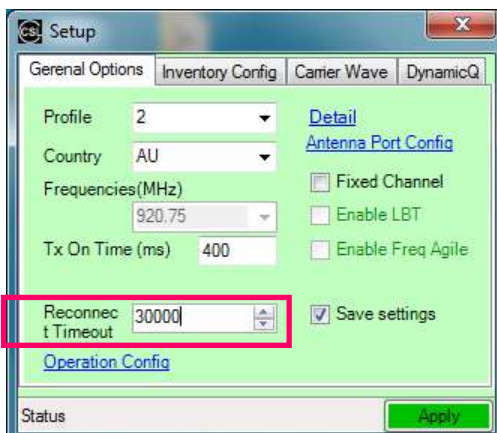

C# Demo App

Click **“Apply”** when the setting is confirmed.

### 7.4 Interface to Reader (C# Demo App)

User can connect to CSL RFID Reader (CS203 / CS468 / CS469) via Ethernet interface. It is the default interface. For some CSL RFID Reader, USB and Serial (RS232) interfaces also available. User should refer to the specification of CSL RFID Reader and check “**Connectivity**” before changing the reader interface setting using the Demo App.

User can use C# Demo App to change the reader interface setting. Press “**Set Interfac**” button in the Main Menu.

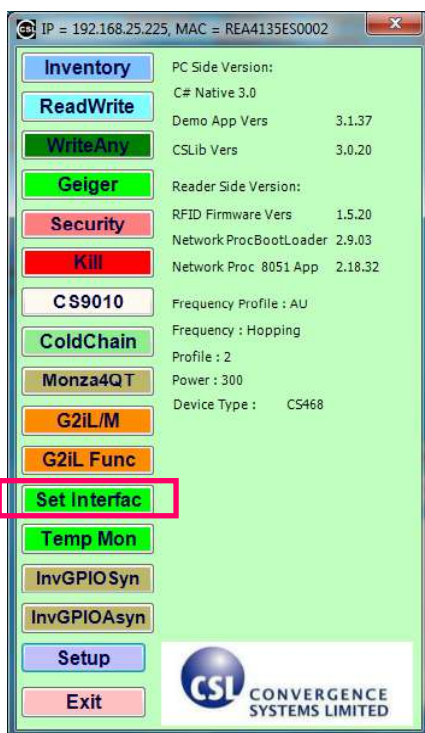

C# Demo App

User can set the reader interface setting with option **Ethernet / USB / Serial** provided as follow.

Press “**OK**” to confirm.



C# Demo App



## 7.5 Antenna Port and Sequence (C# and Java Demo App)

### Antenna Port

User can set the antenna ports of CSL RFID Reader into Active / Inactive state using both C# and Java Demo App.

User should check the number of antenna ports available in the CSL RFID Reader according to the specification. Below is example of CS203, CS468 and CS469:

Number of antenna ports available in CS203:	1	=> Max 1 active port 0
Number of antenna ports available in CS468:	16	=> Max 16 active ports 0 - 15
Number of antenna ports available in CS469:	4	=> Max 3 active ports 0 - 3

To set the ACTIVE / INACTIVE state of CSL RFID Reader antenna ports, user press “Setup” in the Demo App.

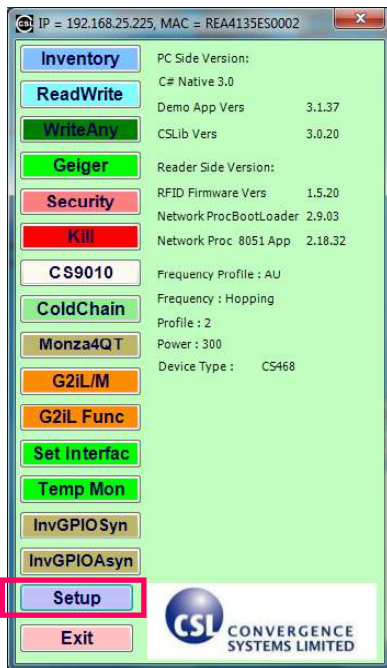

C# Demo App



Java Demo App

If user is using C# Demo App, click on “Antenna Port Config”.

If user is using Java Demo App, click on the tab “Antenna Ports”.

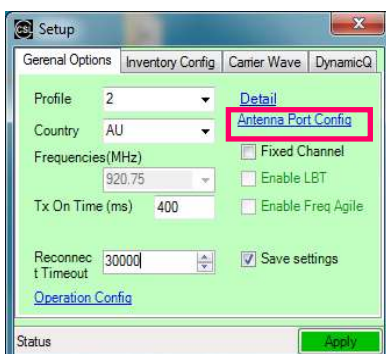

C# Demo App

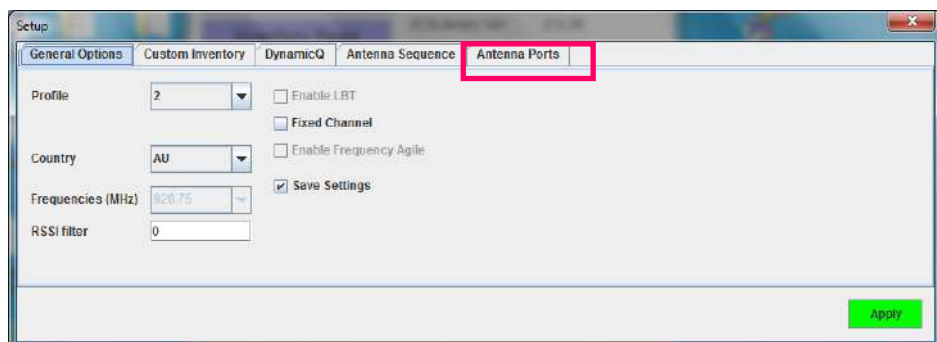

Java Demo App

User can enable the antenna ports by clicking on buttons from “Inactive” to “Active” state.

User can disable the antenna ports by setting buttons from “Active” to “Inactive” state.

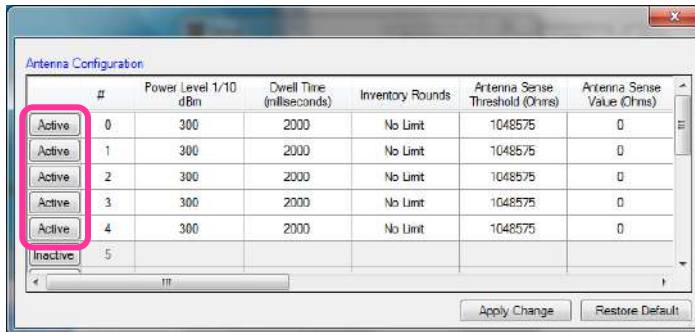

C# Demo App

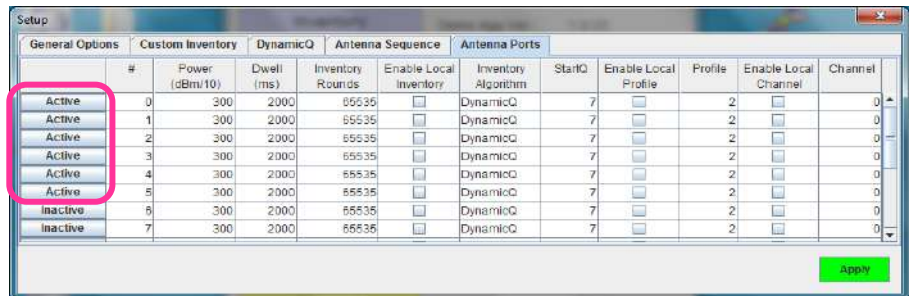

Java Demo App

Click “Apply” when the setting is confirmed. With this setting, each antenna port can have a different output power. However all the Active ports are of the same inventory properties and profile properties and frequency channel properties.

You can also set each port to have a different inventory and profile property and frequency property by ticking the box “Enable Local Inventory” and “Enable Local Profile” and “Enable Local Channel” and then selecting the values you like. The following is an example for a European version, where there are 4 frequency channels and the user can select a different frequency. The Start Q values are also different. This is particularly meaningful because the antenna may be inventorying different number of tags in their operation direction. Of course, for different Q value, one has to be careful as to set the appropriate **Dwell time (The duration time of each antenna port in ms)**. If an antenna is reading a lot of tags, the Dwell time needs to be increased as well.

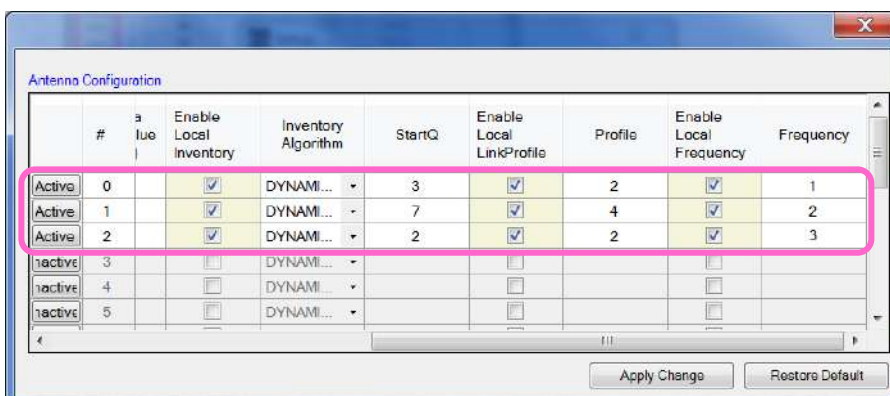

C# Demo App

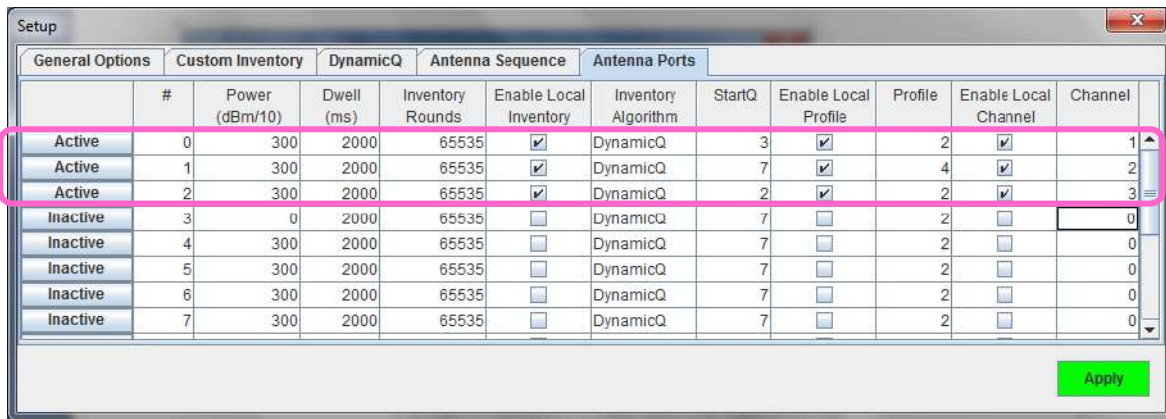

Java Demo App

Antenna Sequence

In “Antenna Sequence” tab, the antenna switching sequence can be configured. This is needed in certain applications where the connected antenna from Port 0 to Port 15 may not be excited in that simple ascending order, but rather in some weird order pertaining to actual physical setup.

1. Normal Mode – The antenna port switching follows the normal port number sequence (e.g., 0, 1, 2, 3, 4, 5, 6, .....14,15 and then repeat from 0 again)
2. Sequence Mode – User-defined antenna port switching sequence (e.g. one can define 0, 15, 1, 14, 2, 13, 3, .....7,8 and then repeat)
3. SmartCheck Mode – Reader detects if there is any tag on each antenna. If there is no tag detected, the reader will switch to next antenna port immediately.
4. Sequence and SmartCheck Mode – Combination of Sequence mode and SmartCheck mode.

User can configure antenna switching sequence when the option “Sequence” or “Sequence and Smart Check” mode is chosen.

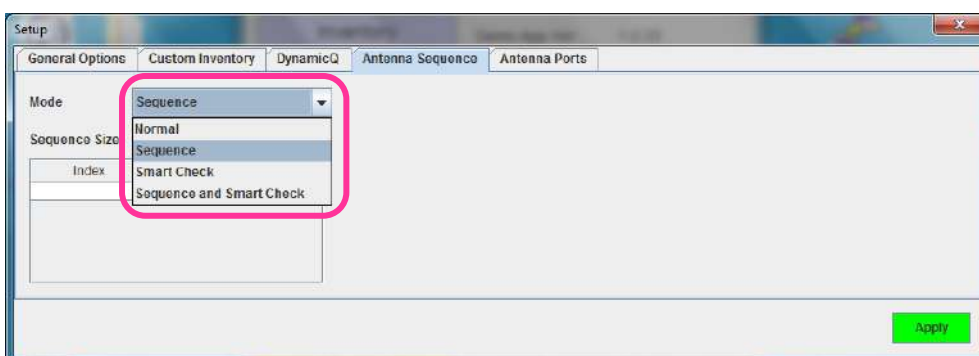

Java Demo App

Enter the “**Sequence Size**”, which is the number of antenna sequence in each cycle. Please note that the **Sequence Size** is equal to the number of active antenna port configured by user.

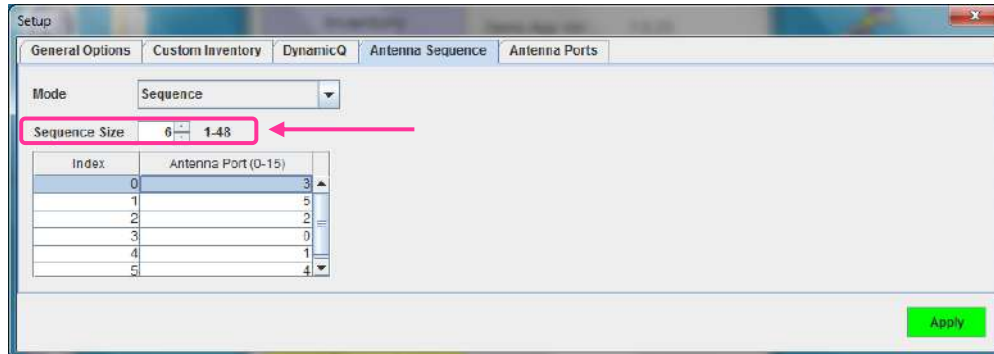

Java Demo App

In the antenna sequence table, input the antenna port switching sequence in the column “**Antenna Port (0-15)**” according to the available active antenna port index.

Click the “**Apply**” button to confirm.

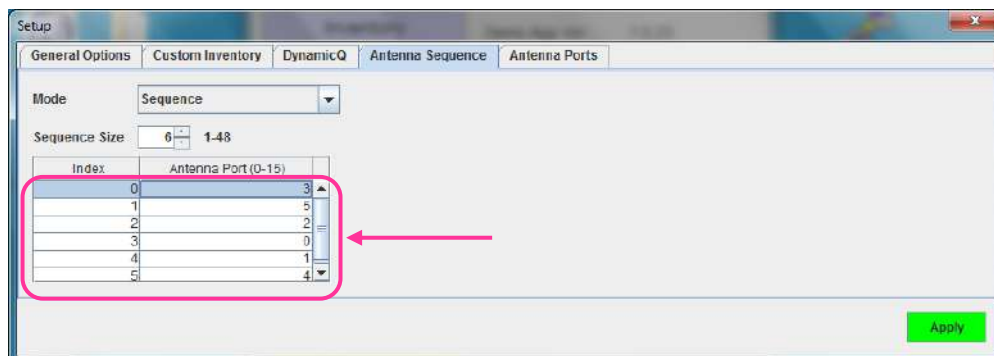

Java Demo App

Click “**Apply**” when the setting is confirmed.

## 7.6 Power Level (C# and Java Demo App)

User can set the power of CSL RFID Reader up to **maximum 30 dBm** using both C# and Java Demo App.

To set up power level of the CSL RFID Reader, press “**Setup**” button in the Main Menu.

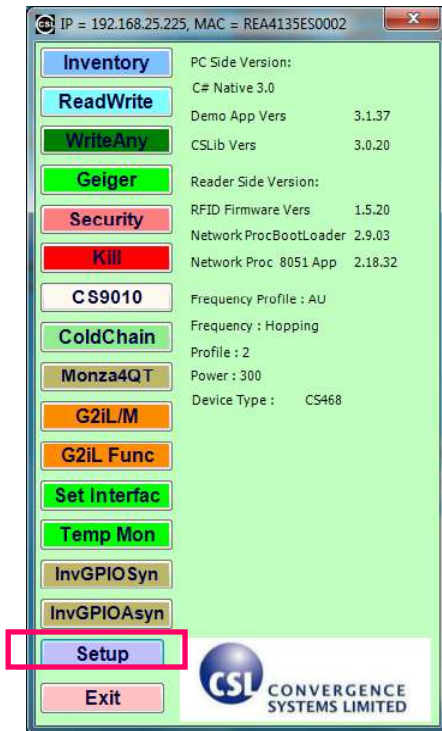

C# Demo App



Java Demo App

If user is using C# Demo App, click on “Antenna Port Config”

If user is using Java Demo App, click on the tab “Antenna Ports”

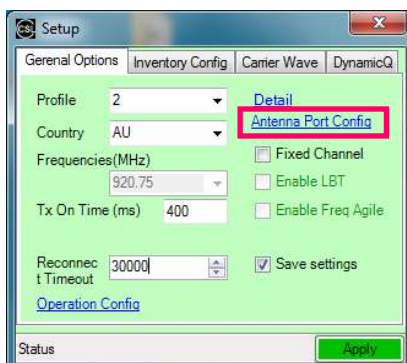

C# Demo App

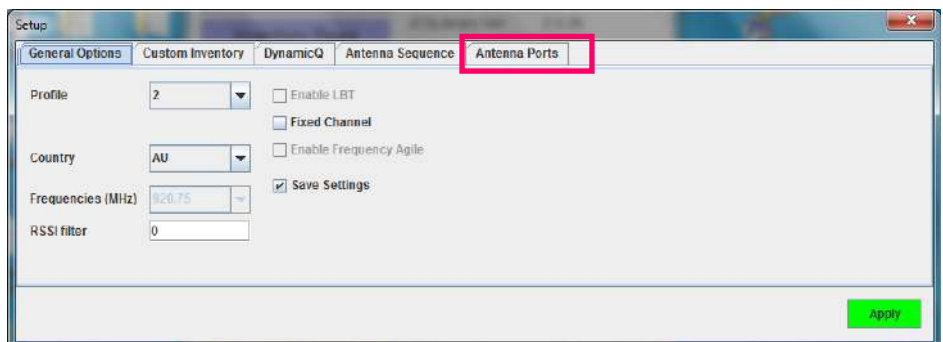

Java Demo App

If user is using C# Demo App, user can change the power level by changing the value in the field **“Power Level 1/10 dBm”**. Press **“Apply Change”** button to confirm.

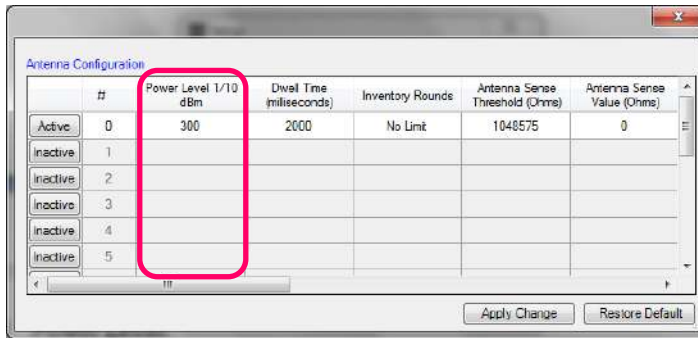

C# Demo App

If user is using Java Demo App, user can change the power level by changing the value in the field **“Power (dBm/10)”**. Press **“Apply”** button to confirm.

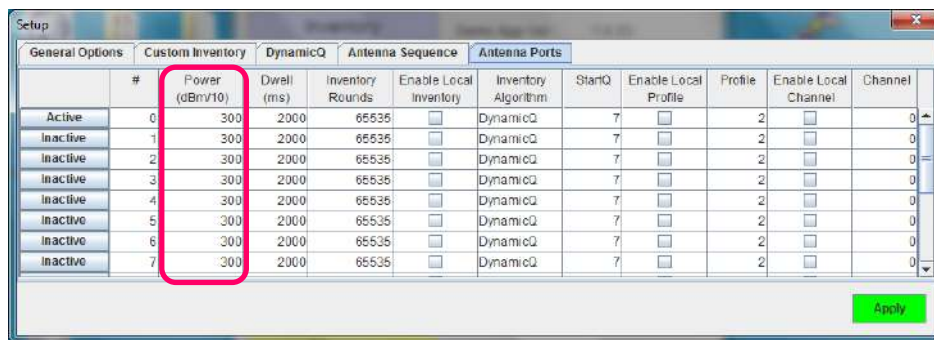

Java Demo App

Please note that Antenna port output power is set in 0.1dBm. The default value is 300, which is equal to 30dBm.

## 7.7 Country, Frequency and Fixed Channel (C# and Java Demo App)

CSL RFID Reader can be used in different region and countries worldwide based on EPCglobal

### “Regulatory status for using RFID in the UHF spectrum”

Country / Region	Frequency	Certification
USA	902MHz ~ 928MHz	(FCC)
Europe	865MHz ~ 868MHz	(CE)
China	920MHz ~ 925MHz	(SRRC)
Japan	915MHz ~ 922MHz	(TELEC)
Australia	920MHz ~ 926MHz	(C-TICK)
India	865MHz ~ 867MHz	-
South Africa	915MHz ~ 919MHz 865MHz ~ 868MHz	(ICASA)
Taiwan	922MHz ~ 928MHz	(NCC)
Hong Kong	920MHz ~ 925MHz	(OFTA)
Malaysia	919MHz ~ 923MHz	(SIRIM)
Singapore	920MHz ~ 925MHz	(FCC)

Please refer to the document “**Regulatory status for using RFID in the UHF spectrum**” and the Order Code of CSL RFID Reader to set the Country, Frequency and Fixed Channel.

The Order Code is **printed at the rear panel of the CSL RFID Reader.**

The format of Order Code is shown as follow:

CS203: CS203ETHER-**N**XHCP  
CS468: CS469-**N**  
CS469: CS468-**N**

where **N**:

**N=1: 865-868 MHz (Europe) & 865-867 MHz (India)**  
**N=2: 902-928 MHz (USA)**  
**N=4: 922-928 MHz (Taiwan)**  
**N=7: 920-925 MHz (China, Australia, Malaysia, Hong Kong etc)**  
**N=8: 915-922 MHz (Japan)**





User can set the Country, Frequency and Fixed Channel of CSL RFID Reader using both C# and Java Demo App.

To set up power level of the CSL RFID Reader, press **“Setup”** button in the Main Menu.

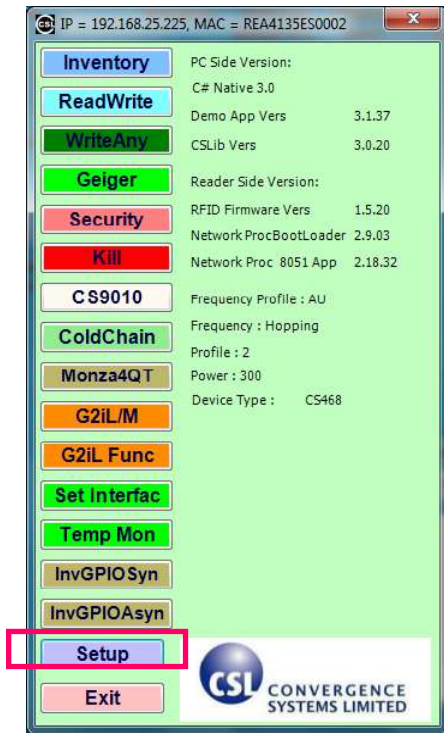

C# Demo App



Java Demo App

If user is using C# Demo App, click on **“General Options”**.

If user is using Java Demo App, click on the tab **“General Options”**.

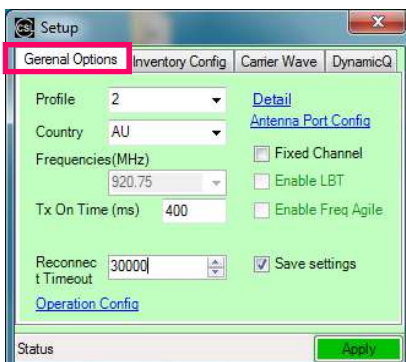

C# Demo App

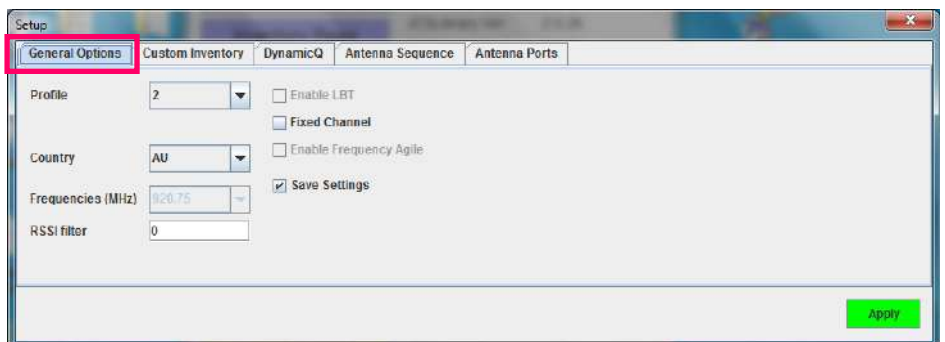

Java Demo App

If user is using C# Demo App, choose the country / region in the field “Country”.

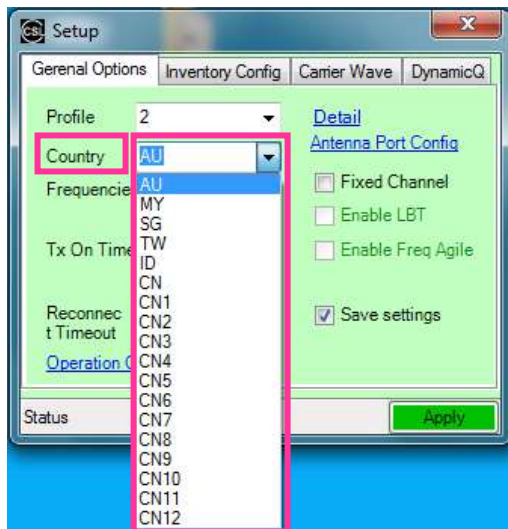

C# Demo App

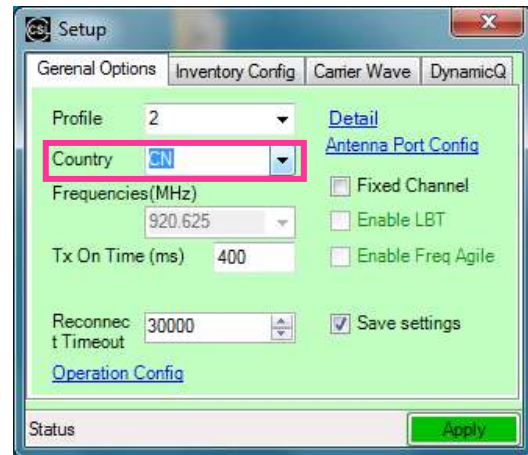

C# Demo App

Country/Region option for CSL RFID readers:

- United state : FCC
- Europe : ESTI
- India : IN
- G800 : G800
- Australia : AU
- Brazil 1 : BR1
- Brazil 2 : BR2
- Hong Kong : HK
- Thailand : TH
- Singapore : SG
- Malaysia : MY
- South Africa : ZA
- Indonesia : ID
- China : CN / CN1 / CN2 / CN3 / CN4 / CN5 / CN6 / CN7 / CN8 / CN9 / CN10 / CN11 / CN12
- Taiwan : TW
- Japan : JP

Below are available options for reader with different order code **N**

N = 1 : ETSI / IN / G800

N = 2 : FCC / AU / BR1 / BR2 / HK / TW / TH / SG / MY / ZA / ID

N = 4 : AU / MY / SG / TW / ID / CN / CN1 / CN2 / CN3 / CN4 / CN5 / CN6 / CN7 / CN8 / CN9 / CN10 / CN11 / CN12

N = 7 : AU / TH / SG / CN / CN1 / CN2 / CN3 / CN4 / CN5 / CN6 / CN7 / CN8 / CN9 / CN10 / CN11 / CN12

N = 8 : JP

If user wants to operate the RFID Reader in **one frequency channel** without frequency hopping, tick the checkbox **“Fixed Channel”** and select the frequency in the field **“Frequencies (MHz)”**.

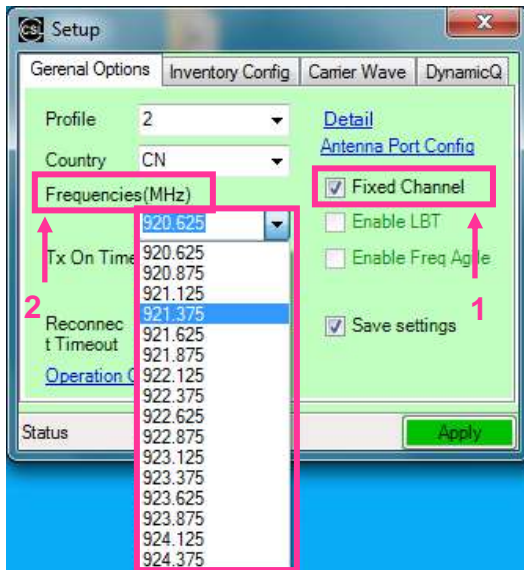

C# Demo App

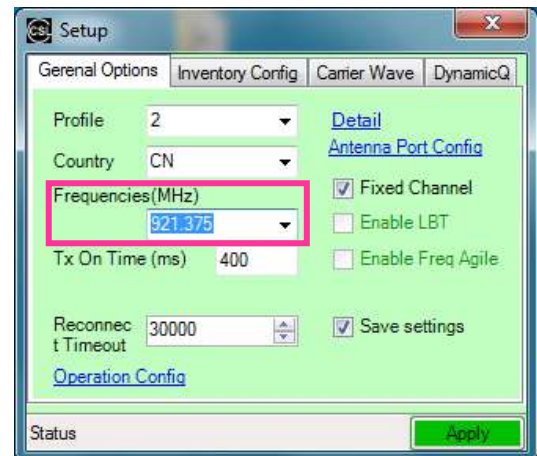

C# Demo App

Click **“Apply”** when the setting is confirmed.

The updated configuration can be checked in the Main Menu of Demo App.



C# Demo App

If user is using Java Demo App, choose the country / region in the field “**Country**” in the tab “**General Options**”.

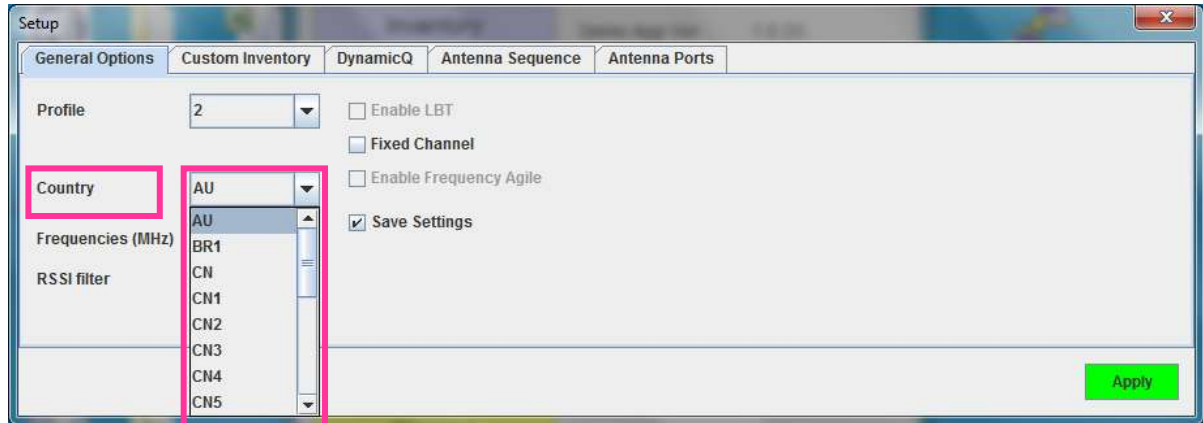

Java Demo App

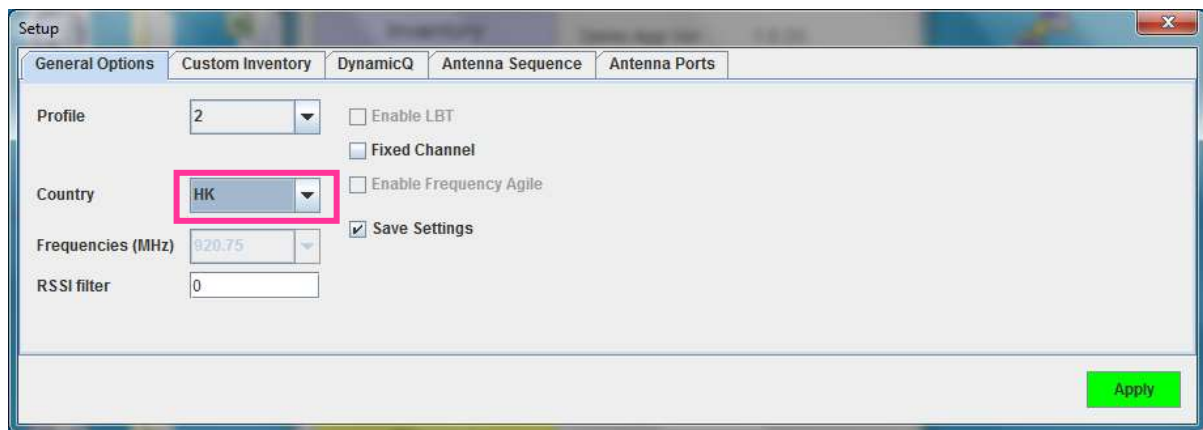

Java Demo App

If user wants to operate the RFID Reader in **one frequency channel** without frequency hopping, tick the checkbox “**Fixed Channel**”.

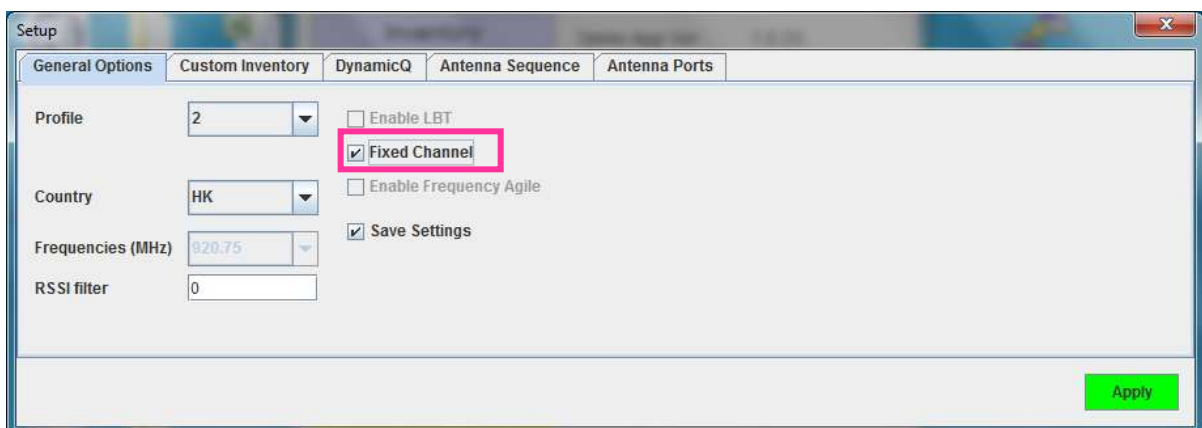

Java Demo App

Click **“Apply”** and wait until the **Main Menu** appears.

Enter the window form again by pressing **“Setup”** button in the **Main Menu** and clicking on the tab **“General Options”**.

Select the frequency in the field **“Frequencies (MHz)”**.

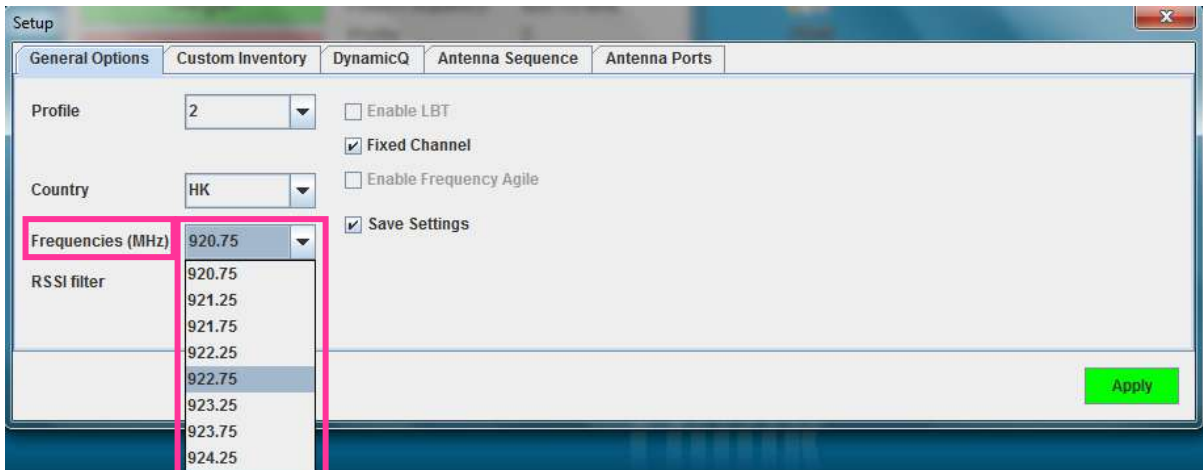

Java Demo App

Click **“Apply”** when the setting is confirmed.

The updated configuration can be checked in the Main Menu of Demo App.

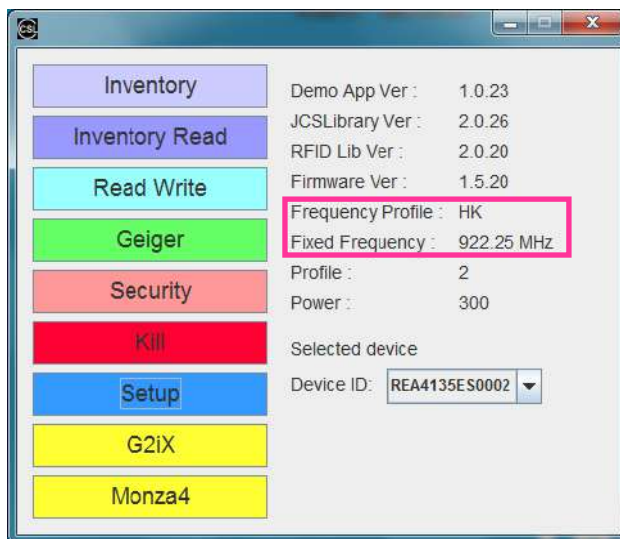

Java Demo App

## 7.8 RSSI Filter (C# and Java Demo App)

The RSSI (Received Signal Strength Indicator) value is an indicator of signal strength from an RFID tag to an RFID reader.

Normally RSSI can be used in

- Estimating the distance between an RFID tag and an RFID reader. The higher the RSSI value, the closer the RFID tag is to the reader. (The environment is analyzed and taken into consideration.)
- Identifying the movement direction of an RFID tag. (As the RFID tag moves closer to the RFID reader, the RSSI value increases. When the RFID tag moves away from the RFID reader, the signal gets weaker)
- Setting optimal reading and writing conditions. (RSSI value can be used to analyze the tag reading and writing conditions. The optimal condition is to be able to use as little power as possible for achieving a strong enough signal to perform the RFID actions)
- Analyzing and optimizing the environment.
- Locating lost tags. (Geiger search: Many retail and supply chain operations require a "locate tag" application. The RSSI value can be used for guiding the user closer and closer to the target)

By applying RSSI filters only tags within a certain distance are registered. RFID reading and writing conditions can be optimized for specific applications.

To obtain the threshold value, user can use Geiger to get the RSSI value range of using a tag located at a distance from the CSL RFID reader.

If user is using C# Demo App, press “Geiger” in the Main Menu.



C# Demo App

Place the tag in front of reader antenna (Port 0) for distance estimation.

In the GeigerSearchForm, press “Geiger”, user can check the range of RSSI value.



C# Demo App



C# Demo App



Go to the Main Menu. Press **“Setup”** in the Main Menu.



C# Demo App

Click on **“Inventory Config”**, tick the checkbox **“Enable”** and set the RSSI threshold value in the field **“RSSI filter”**. The filter will ignore tags with RSSI value less than the threshold set.

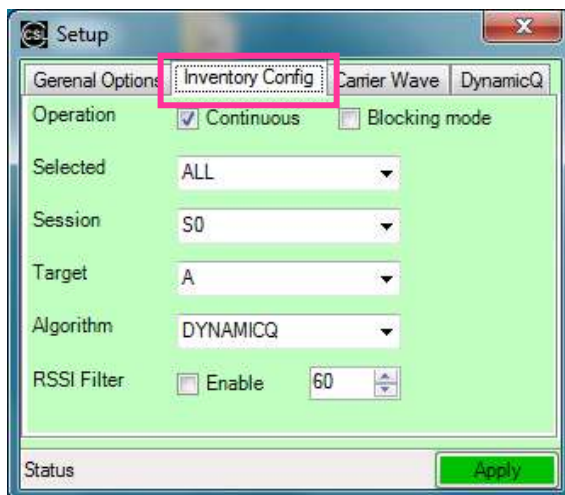

C# Demo App

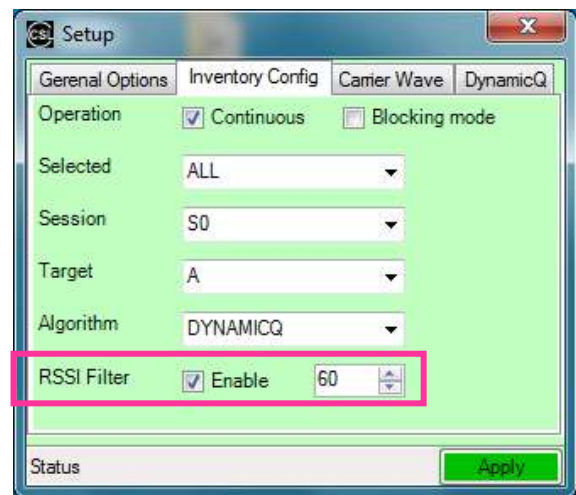

C# Demo App

Click **“Apply”** to confirm the setting.

If user is using Java Demo App, press **“Geiger”** in the Main Menu.



Java Demo App

Place the tag in front of reader antenna (Port 0) for distance estimation.

Click **“Search”** and wait until the tag for distance is found. Select the tag and click **“Geiger”** tab.

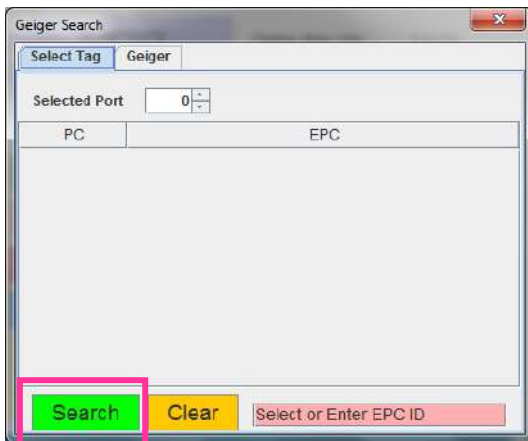

Java Demo

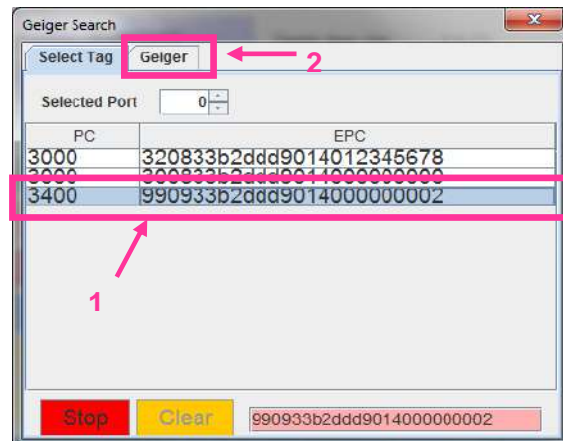

Java Demo App

In **“Geiger”** tab, click **“Geiger”** and check the range of RSSI value.

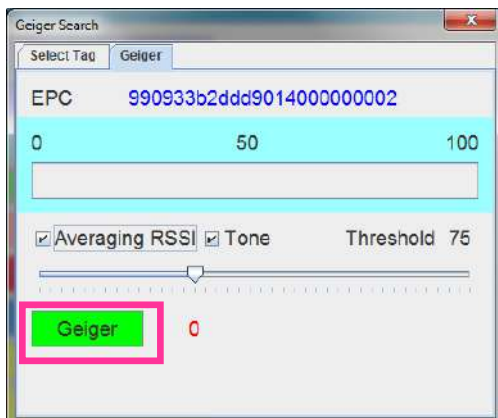

Java Demo App



Java Demo App

Go to the Main Menu. Press **“Setup”** in the Main Menu.



Java Demo App

In **“General Options”**, set the RSSI threshold value in the field **“RSSI filter”**.

The filter will ignore tags with RSSI value less than the threshold set.

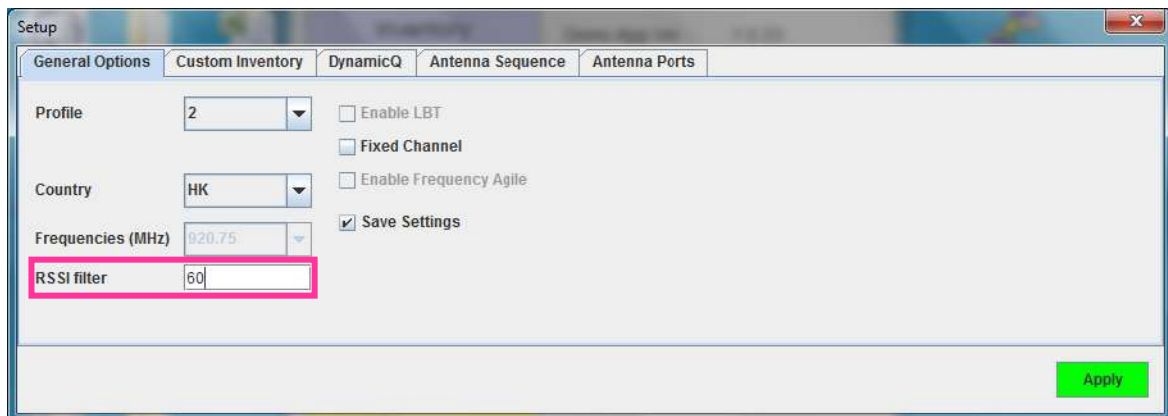

Java Demo App

Click **“Apply”** to confirm the setting.

## 7.9 Link Profile (C# and Java Demo App)

Different modulation profile of RFID reader (Interrogator) and the Tag can be selected by the user for different situation.

User should refer to the document **EPC Radio-Frequency Identity Protocols Class-1 Generation-2 UHF RFID Protocol for Communications at 860 MHz – 960 MHz** by EPCglobal when setting Link Profile.

The default setting is profile 2. It is also the recommended setting for most of the common applications. In CS468-3 (Japan) and CS468-1 (ETSI) readers, only profiles 0, 2, 3 and 5 are selectable. (Profile 0 is also not advised for CS468-3 Japanese reader).

Profile	0	1	2	3	4	5
R-T Modulation	DSB-ASK	DSB-ASK	PR-ASK	PR-ASK	DSB-ASK	DSB-ASK
Tari (µs)	25.00	12.5	25.00	25.00	6.25	25.00
R-T speed (kbps)	40	80	40	40	160	40
PIE	2 : 1	2 : 1	1.5 : 1	1.5 : 1	1.5 : 1	1.5 : 1
Pulse Width (uS)	12.50	6.25	12.50	12.50	3.13	12.50
T-R LF (kbps)	40	160	250	300	400	250
T-R Modulation	FM0	Miller-2	Miller-4	Miller-4	FM0	Miller-2
Divide Ratio	8	8	64 / 3	64 / 3	8	64 / 3
T-R Data Rate (kbps)	40	80	62.5	75	400	125

DSB-ASK Double-sideband amplitude shift-keying

PR-ASK Phase-reversal amplitude shift keying

R-T Modulation Interrogator-to-Tag modulation

T-R Modulation Tag-to-Interrogator modulation

Tari Reference time interval for a data-0 in Interrogator-to-Tag signaling. The mnemonic "Tari" derives from the ISO/IEC 18000-6 (part A) specification, in which Tari is an abbreviation for Type A Reference Interval.

User can set the Link Profile of CSL RFID Reader using both C# and Java Demo App.

To set up power level of the CSL RFID Reader, press **“Setup”** button in the Main Menu.

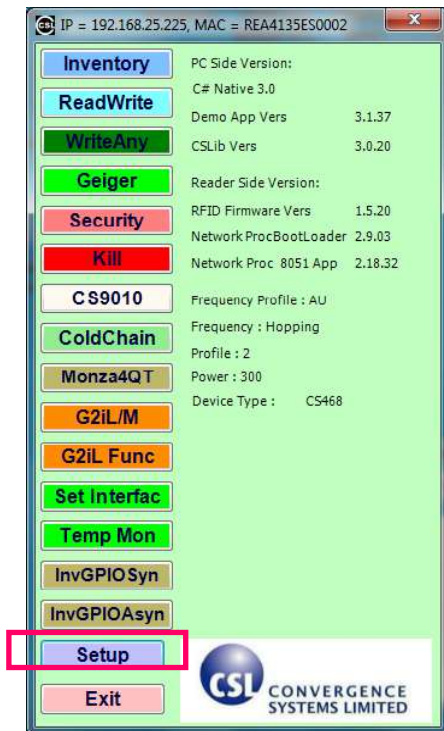

C# Demo App

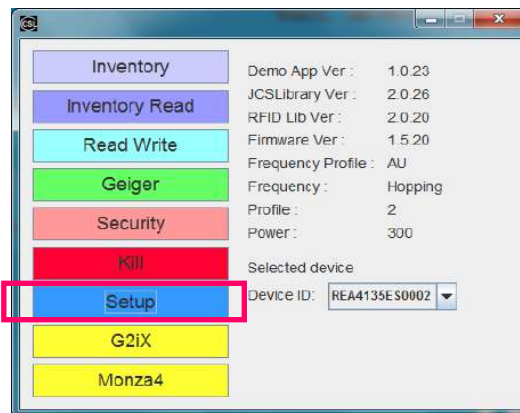

Java Demo App

If user is using C# Demo App, click on **“Antenna Port Config”**

If user is using Java Demo App, click on the tab **“Antenna Ports”**

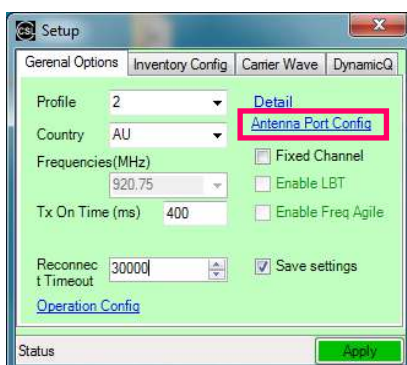

C# Demo App

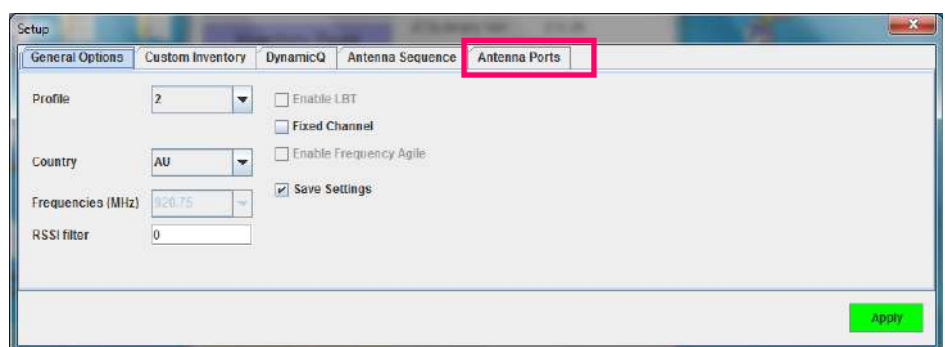

Java Demo App

If user is using C# Demo App, user can tick the checkbox in “**Enable Local LinkProfile**” and change the value in the field “**Profile**” for **INDIVIDUAL ACTIVE PORT**.

Press “**Apply Change**” button to confirm.

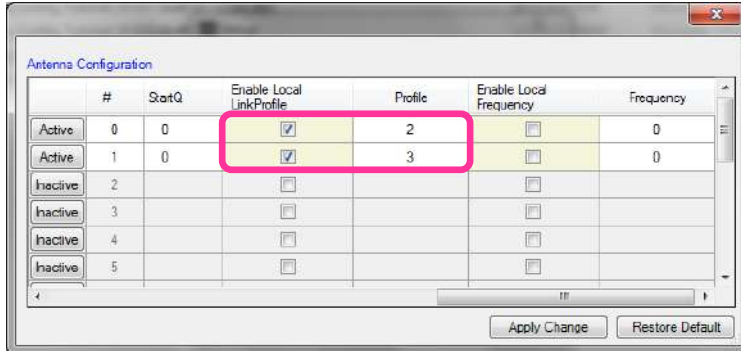

C# Demo App

If user is using Java Demo App, user can tick the checkbox in “**Enable Local Profile**” and change the value in the field “**Profile**” for **INDIVIDUAL ACTIVE PORT**.

Press “**Apply**” button to confirm.

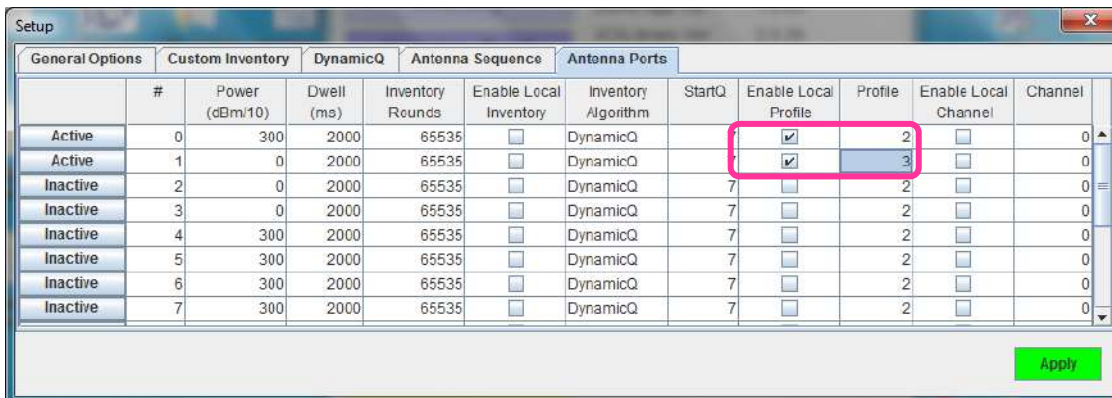

Java Demo App

If user wants to set the Profile for **ALL ACTIVE PORTS** instead of **INDIVIDUAL PORT** in the reader, the field “**Profile**” in the **Setup** menu is provided. **All the ports share the same setting**.

(User should have those checkboxes in “**Enable Local Profile**” unchecked before use)

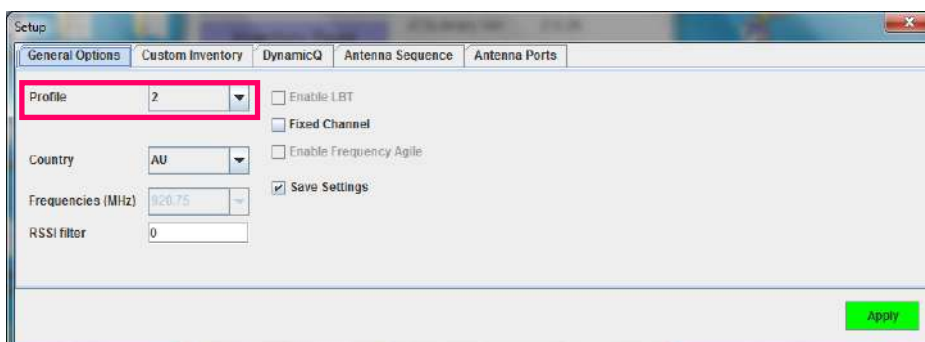

Java Demo App

## 7.10 Target and Toggle A / B Flag (C# and Java Demo App)

There are 2 meanings for **Target** in the standard of **EPC Radio-Frequency Identity Protocols Class-1 Generation-2 UHF RFID Protocol for Communications at 860 MHz – 960 MHz** by EPCglobal. One of them is the parameter of RFID protocol **Inventory – Select** Command, which indicates whether the Select command modifies a Tag's Selected (SL) flag or its inventoried flag.

Another **Target** is the parameter of RFID protocol **Inventory – Query** Command, which selects whether Tags whose inventoried flag is **A or B** participate in the inventor round. Tags may change their inventoried from A to B (or vice versa) as a result of being singulated.

In CSL RFID Reader Read / Write configuration, **Target** is the parameter of RFID protocol **Inventory – Query** Command. The options for Query Command in the field **Target** are "A", "B" and "Unknown". User can set the Target of CSL RFID Reader using both C# and Java Demo App.

Inventory contains a designation of the tags with which flag is to be inventoried. User can define it to be Flag A, or Flag B. There is also a parameter toggle, if user set it to "on", i.e. toggle, then in continuous inventory it will inventory Flag A in the first round, then Flag B in the next round, and so on. If user set it to "off", then it will keep on inventorying the same flag.

So the usual trick is to set inventory to read Flag A, and toggle to off. Then it will keep on reading Flag A tags. Those that have been read will become flag B and it will not respond to an inventory of Flag A tags. This will the crowded situation will improve as reader read more and more tags, leaving only those who have not been read yet (hence still in flag A state) to respond with no jamming by others.

Tag when first booted up (powered up) has Flag A. After it is inventoried, it will become Flag B for certain period of time depending on the persistence selection. Please check EPCGlobal specs in detail.

To set up **Target** of the CSL RFID Reader, press **“Setup”** button in the Main Menu.

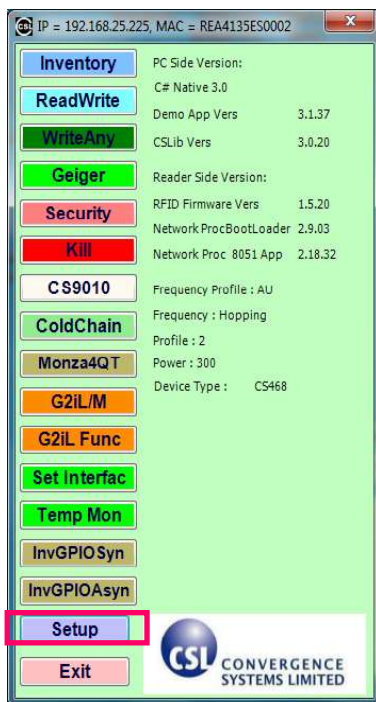

C# Demo



Java Demo App

If user is using C# Demo App, click on **“Inventory Config”**.

If user is using Java Demo App, click on the tab **“Custom Inventory”**.

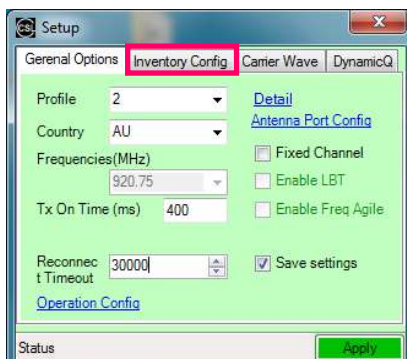

C# Demo App

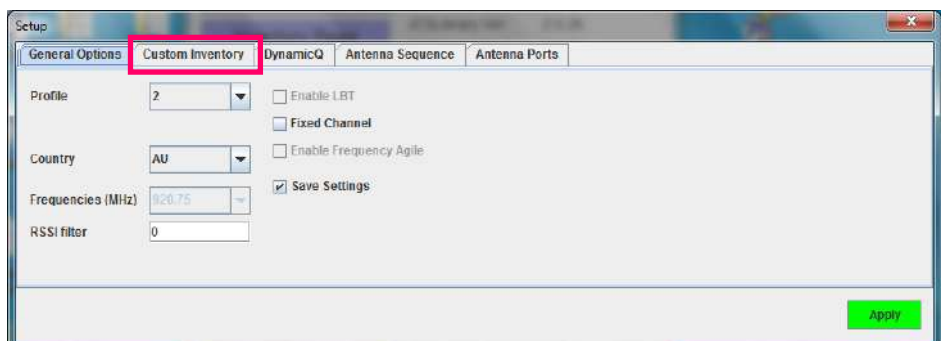

Java Demo App



Check the field “**Target**” in the tab, user can choose A / B / UNKNOWN.

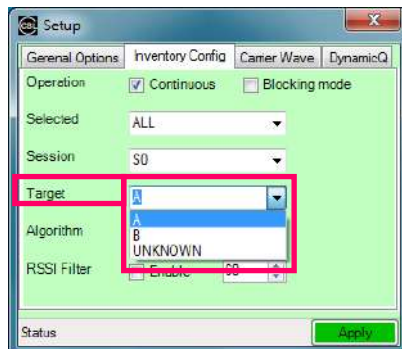

*C# Demo App*

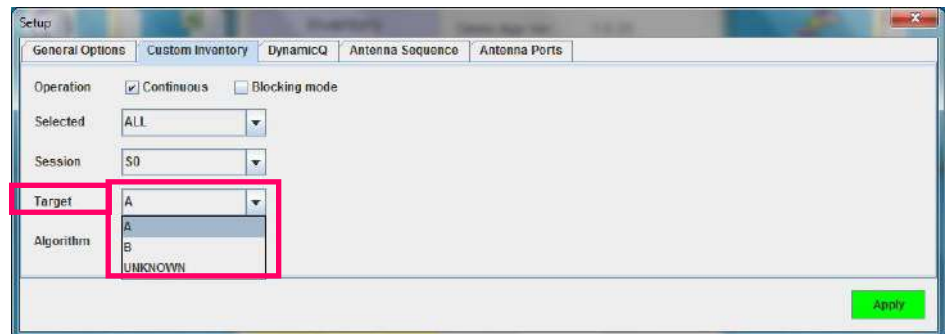

*Java Demo App*

Press “**Apply**” button to confirm.

## 7.11 Session and Tag Selection (C# and Java Demo App)

Session is an inventory process comprising a reader and an associated Tag population. A reader chooses one of four sessions and inventories Tags within that session. The reader and associated Tag population operate in one and only one session for the duration of an inventory round. For each session, Tags maintain a corresponding inventoried flag. Sessions allow Tags to keep track of their inventoried status separately for each of four possible time-interleaved inventory processes, using an independent inventoried flag for each process.

## 7.12 Slot-Count Parameter Q and Dwell Time (C# and Java Demo App)

RFID Protocol **Inventory - Query** Command contains a **Slot-Counter Parameter Q**.

When participating Tags receive a Query, they pick a pseudo-random value in the range  $(0, 2^Q-1)$  and load this value into their slot counter. Tag which picks a zero transition to the reply state replies immediately. Tags which pick a nonzero value transition to the arbitrate state await a QueryAdjust or a QueryRep command to decrement the value in its slot counter. Tags reply when the value in their slot counter (i.e. their slot) is zero. Since Q is an integer in the range  $(0, 15)$ , the corresponding Tag-response probabilities range from  $2^0 = 1$  to  $2^{-15} = 0.0000305$ .

It is usually recommended to set a Q-value that have the corresponding number of slots larger than the exact maximum number of Tags to be read by the reader. For example, if there are 40 tags to be read by the reader, the Q-value is configured to 6, in which  $2^Q = 2^6 = 64 > 40$ .

## 7.13 Inventory Algorithm: Fix Q and Dynamic Q Algorithm (C# and Java Demo App)

In CSL RFID readers, it consists of two main inventory algorithms (Fixed Q Algorithm and Dynamic Q Algorithm). The variable Q algorithms differ in their mechanism for adjusting the Q values at the end of each round. It also provides routines for the four tag access functions (read, write, kill and lock).

### Fixed Q Algorithm

This algorithm runs all inventory rounds with a single Q value. In this algorithm an inventory cycle consists of one or more rounds, each of which will attempt to read every slot. The number of slots to search is given by  $2^Q$ . For example, a Q of 7 will cause the algorithm to search 128 slots on each round. One word of caution, if the time it takes to run the round is greater than the frequency hop time (and the session is 0) or **antenna dwell time (The duration time of each antenna port in ms)**, the round will never complete.

### Dynamic Q Algorithm

In this algorithm, the value of Q is dynamically adjusted based on the periodic evaluation of the relative frequency of **RN16 (16-bit random or pseudo-random number)** timeouts versus EPC timeouts. Each round is comprised of a Query and up to MaxReps QueryReps. The value of Q for the subsequent round is determined by the results of the current round. If the number of RN16 timeouts is greater than the number of EPC timeouts multiplied by thresHi, Q is decremented (presumed empty slots outnumber presumed collisions). If the number of RN16 timeouts is less than the number of EPC time outs times thresLo, Q is incremented (presumed collisions outnumber presumed empty slots). If the number of RN16 time outs falls between those two values, Q remains unchanged.

An inventory cycle is comprised of one or more inventory rounds, and is terminated when a round is executed with Q = 0 and no tags read.

To set up power level of the CSL RFID Reader, press “**Setup**” button in the Main Menu.

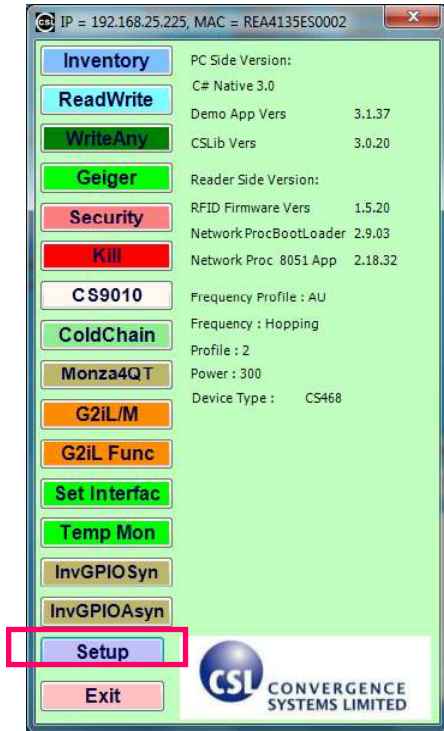

C# Demo App



Java Demo App

If user is using C# Demo App, click on “Inventory Config”.

If user is using Java Demo App, click on the tab “Custom Inventory”.

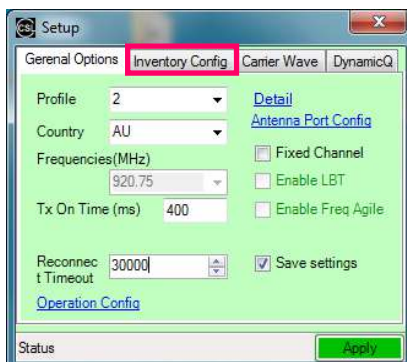

C# Demo App

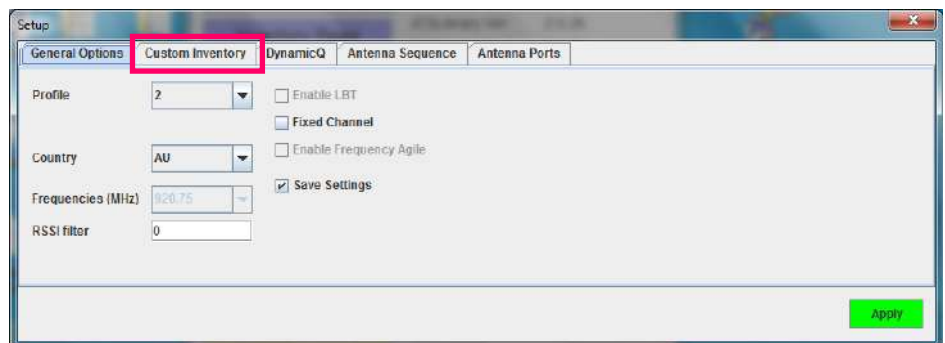

Java Demo App

In the field “Algorithm”, choose “**FIXEDQ**” for Fixed Q Algorithm, “**DYNAMICQ**” for Dynamic Q Algorithm.

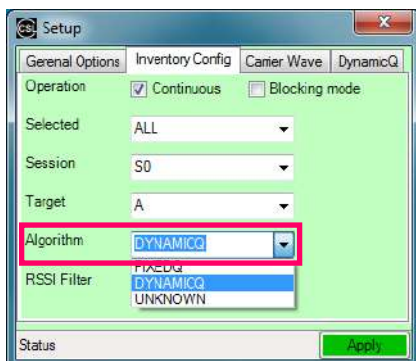

C# Demo App

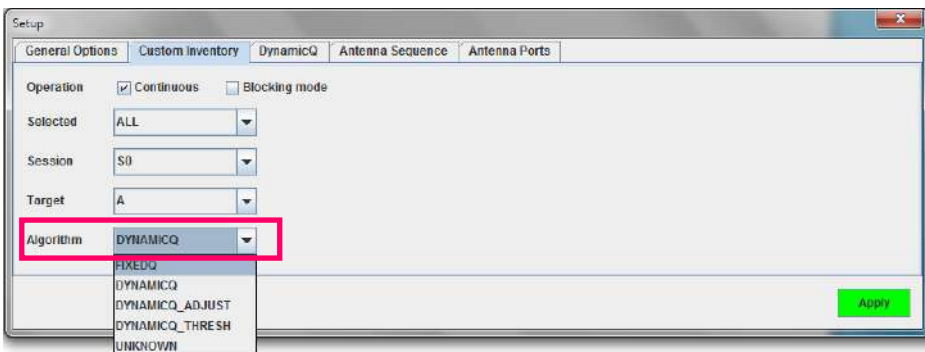

C# Demo App

If “**FIXEDQ**” is chosen, user can go to the tab “**FixedQ**” and set the value of Q in the field “**Q Value**”.

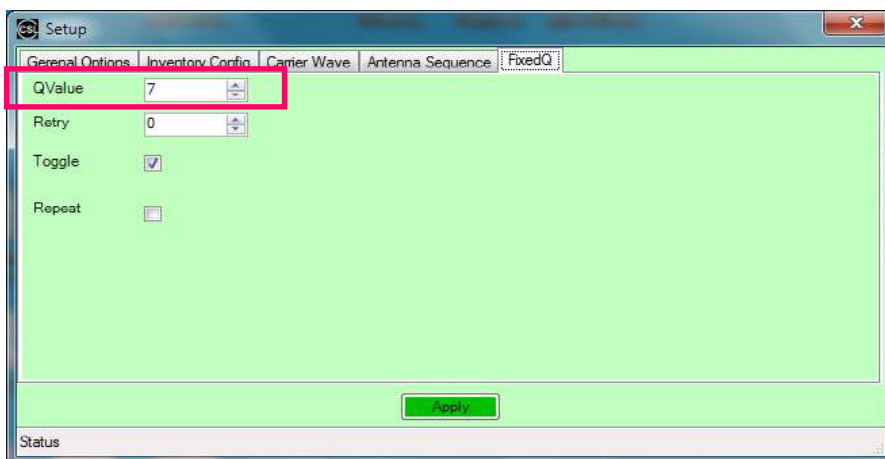

C# Demo App

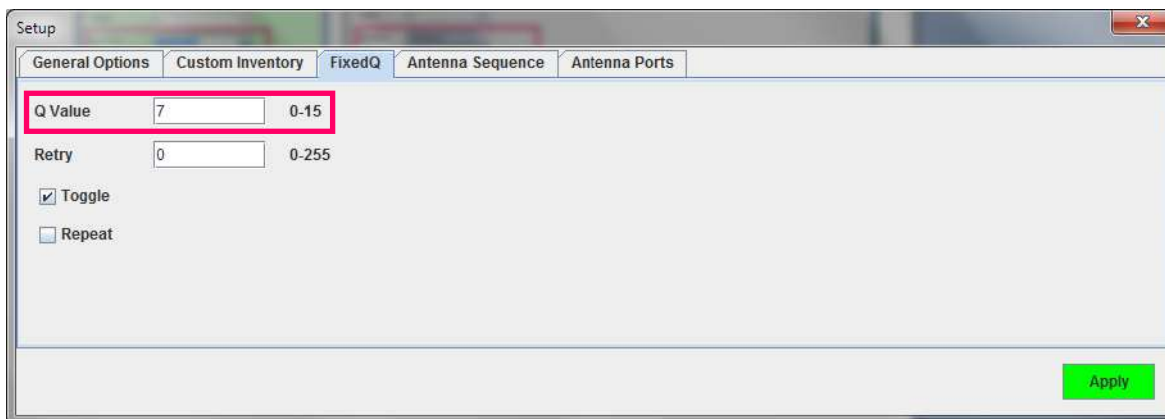

Java Demo App

If “**DYNAMICQ**” is chosen, user can go to the tab “**DynamicQ**” and set the value of Start Q in the field “**StartQValue**”.

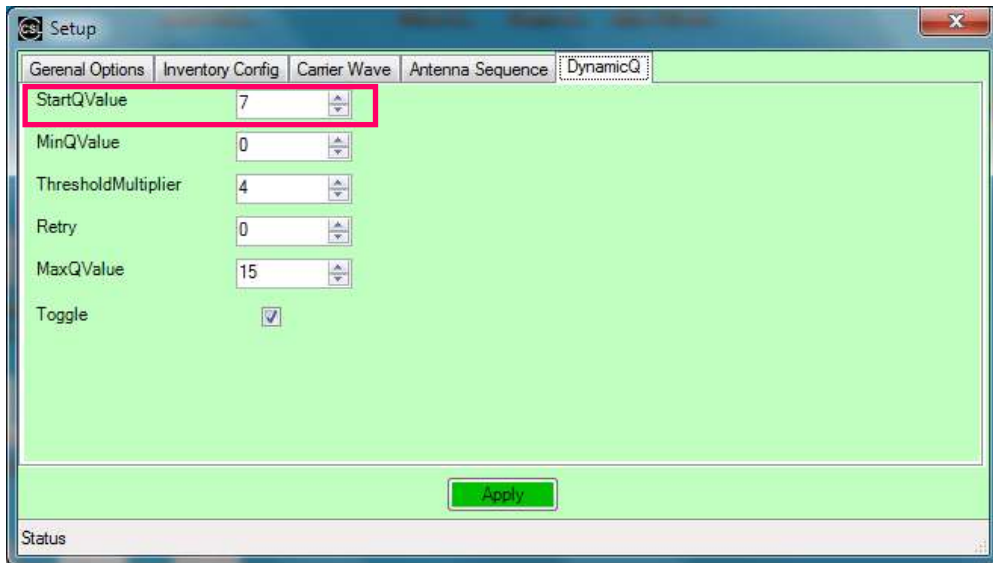

C# Demo App

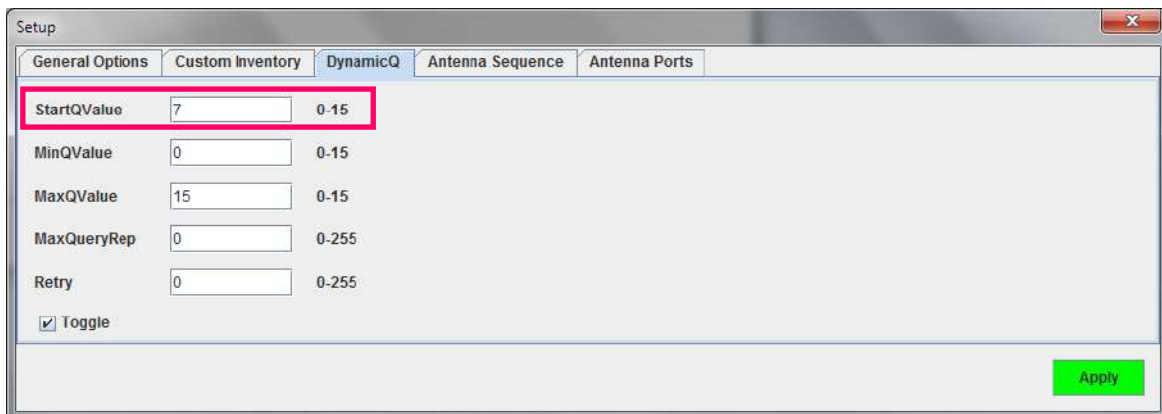

Java Demo App

## 7.14 Read TID, User Bank and Save Tag Data in Log File (C# Demo App)

For RFID Tag with **TID bank** available, user can use C# Demo App to read TID data.

Go to **“Inventory”** in Demo App. Tick the checkbox in the field **“Read TID”**. Fill in the blanks for **offset value** and **number of word read from TID bank**.

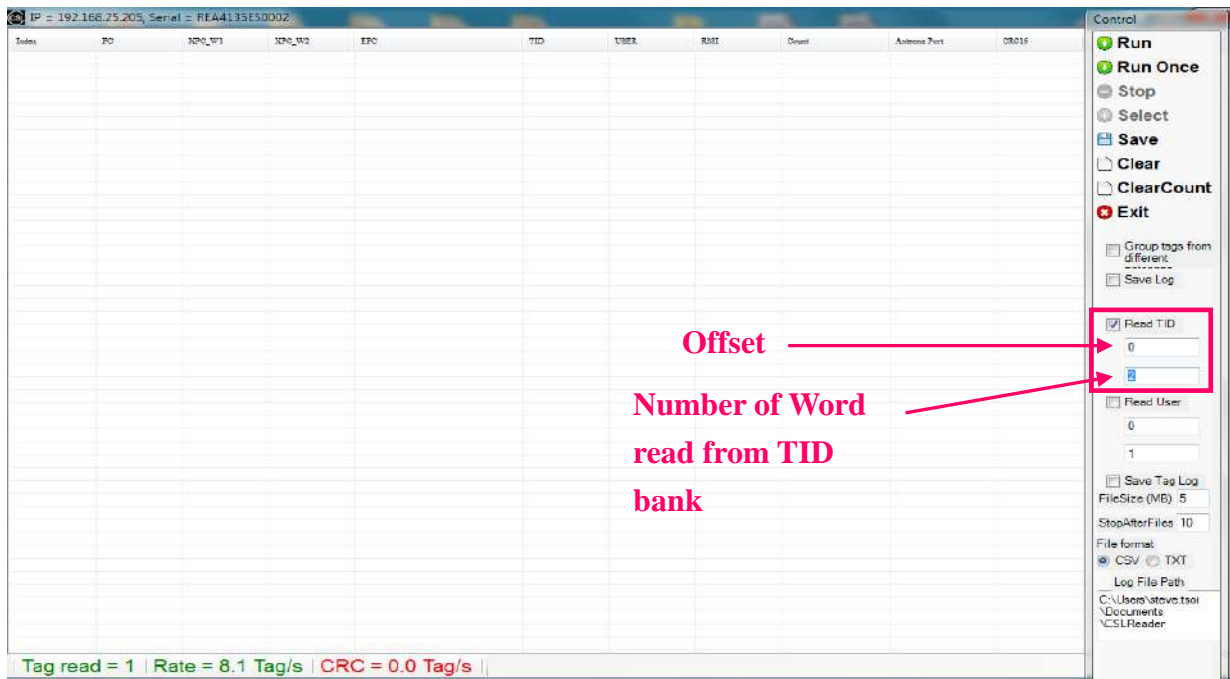

Click **“Run”** and check the EPC to verify the tag with TID data available, TID data can be checked in **“TID”** column.

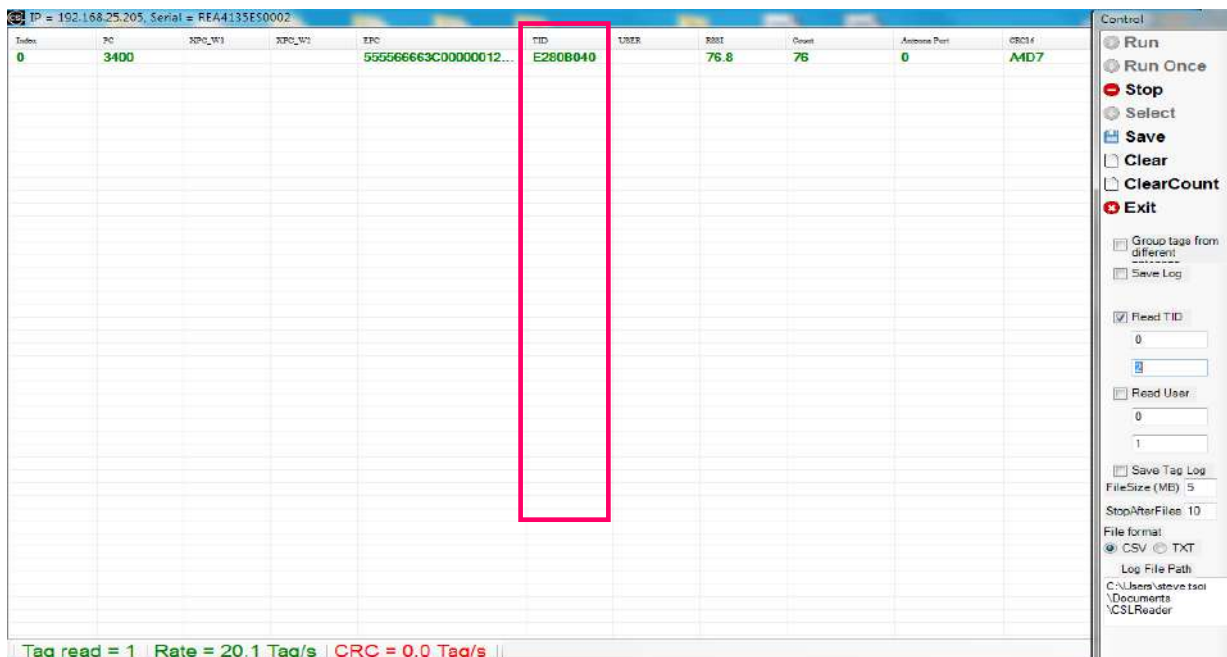

For RFID Tag with **User bank** available, user can use C# Demo App to read User data.

Go to **“Inventory”** in Demo App. Tick the checkbox in the field **“Read User”**. Fill in the blanks for **offset value** and **number of word read from User bank**.

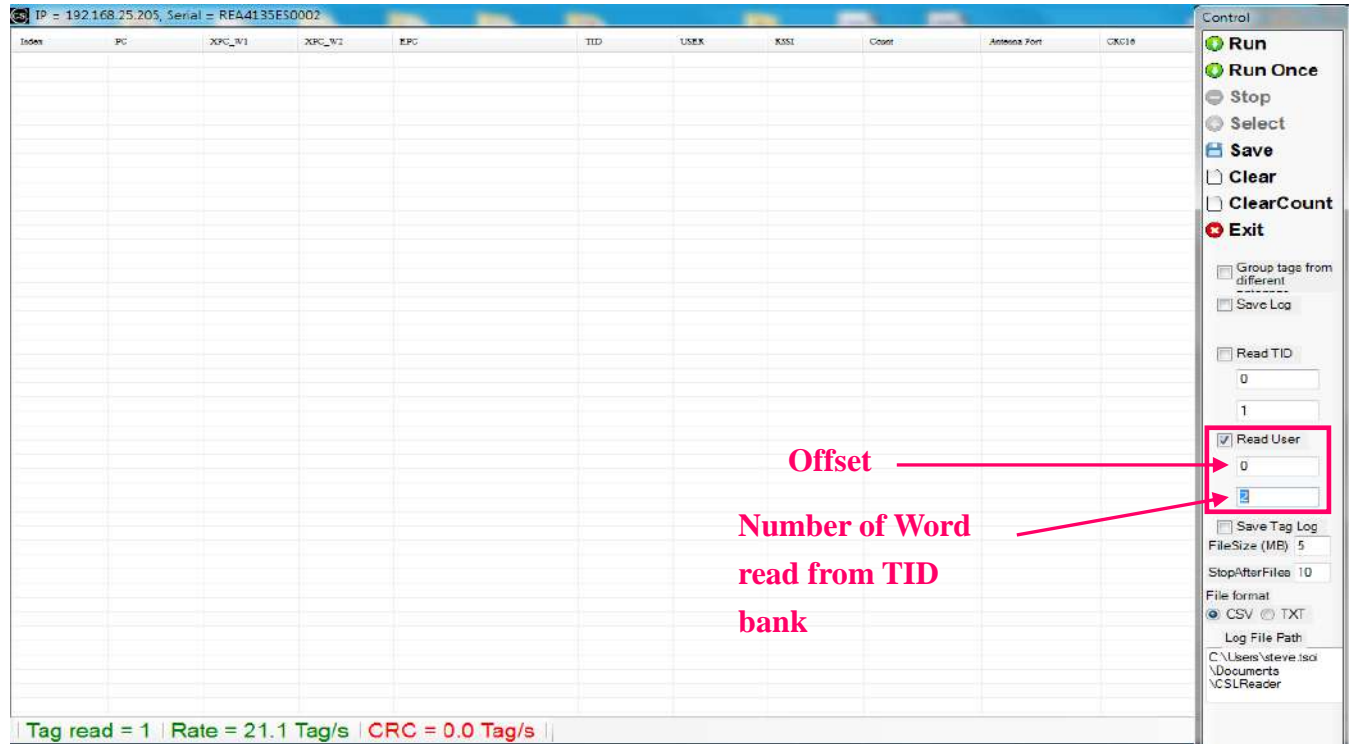

Click **“Run”** and check the EPC to verify the tag with User data available, User data can be checked in **“USER”** column

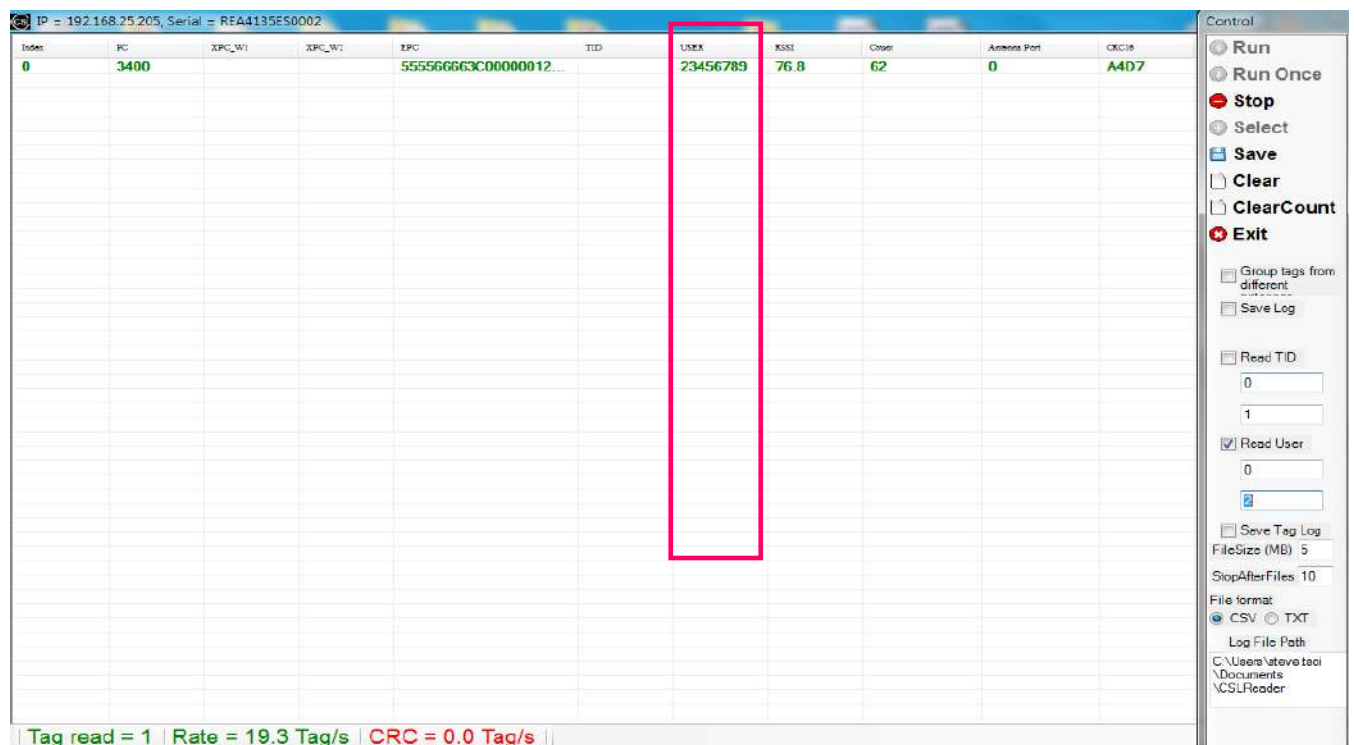



User can **record the status of the CSL Reader** in TXT format.

To record the status of the reader, user can tick the checkbox **“Save Log”** in **Inventory mode**.

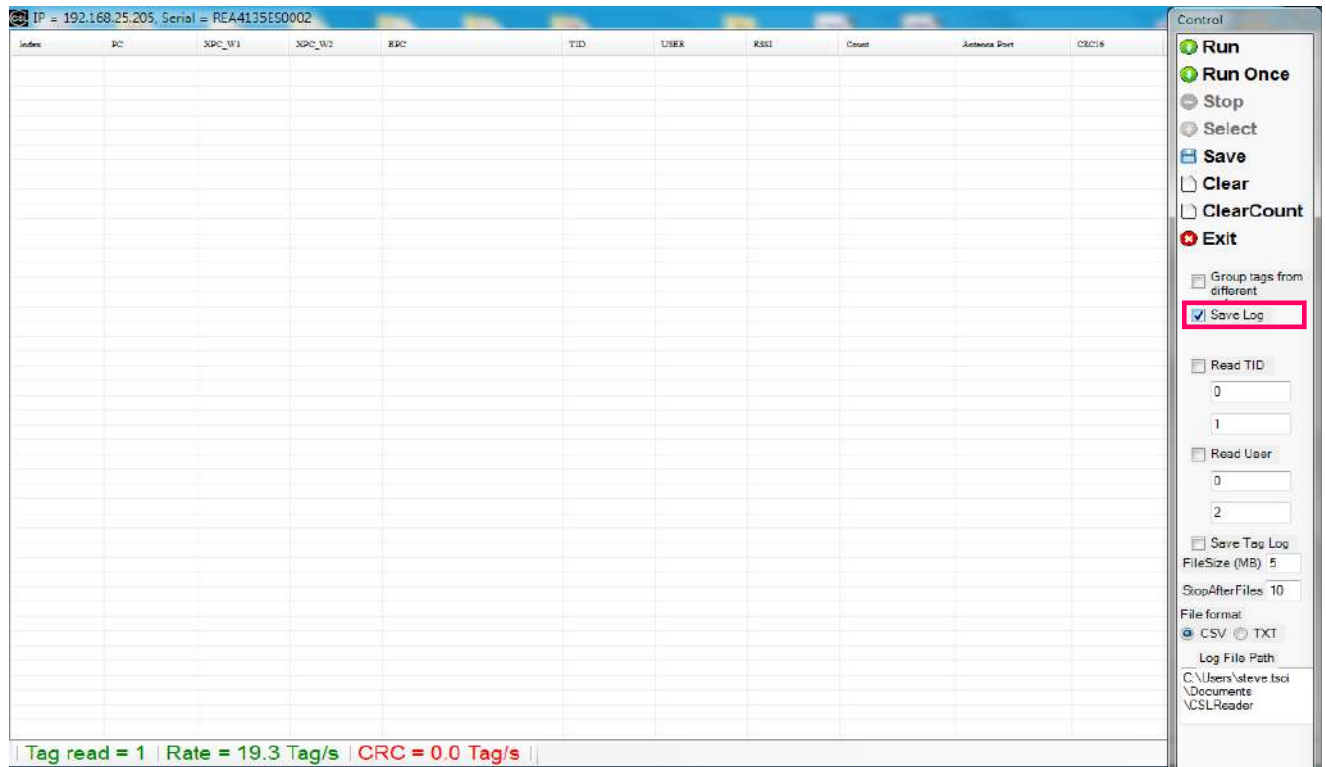

Click **“Run”** and check the EPC data of the tags.

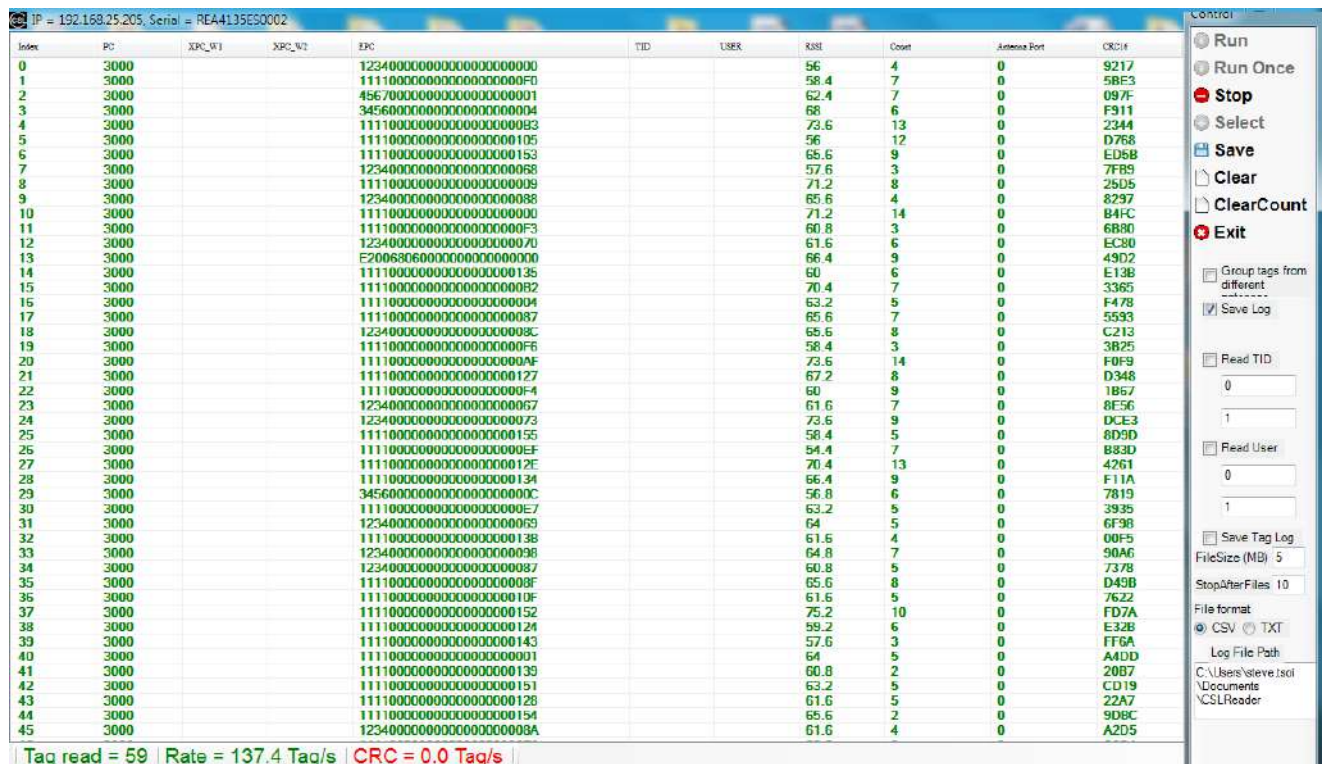

Go to directory “**Libraries > Documents > CSLReader**”, user can find the file which the reader status recorded in “**CycleLog.Txt**”.

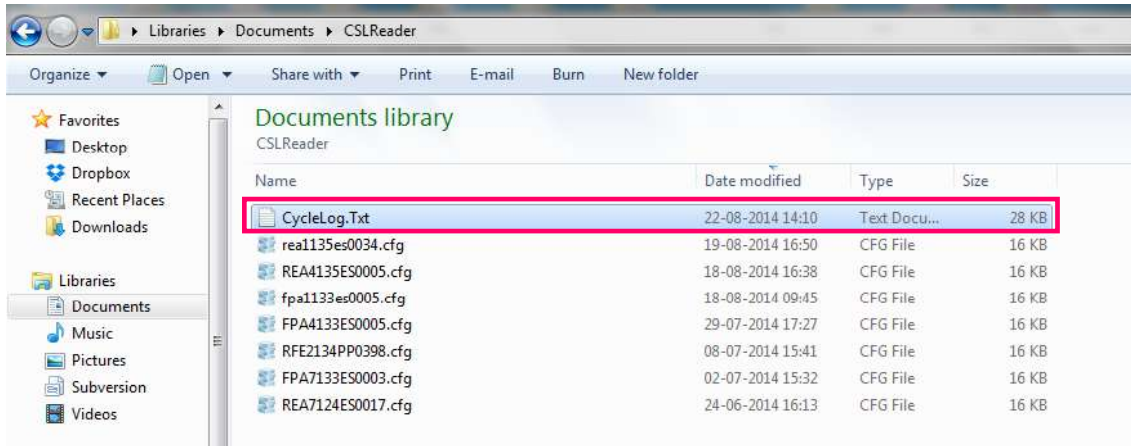

Open the file “**CycleLog.Txt**”. The reader **status of number of tags per cycle** and **system reset record** can be found.

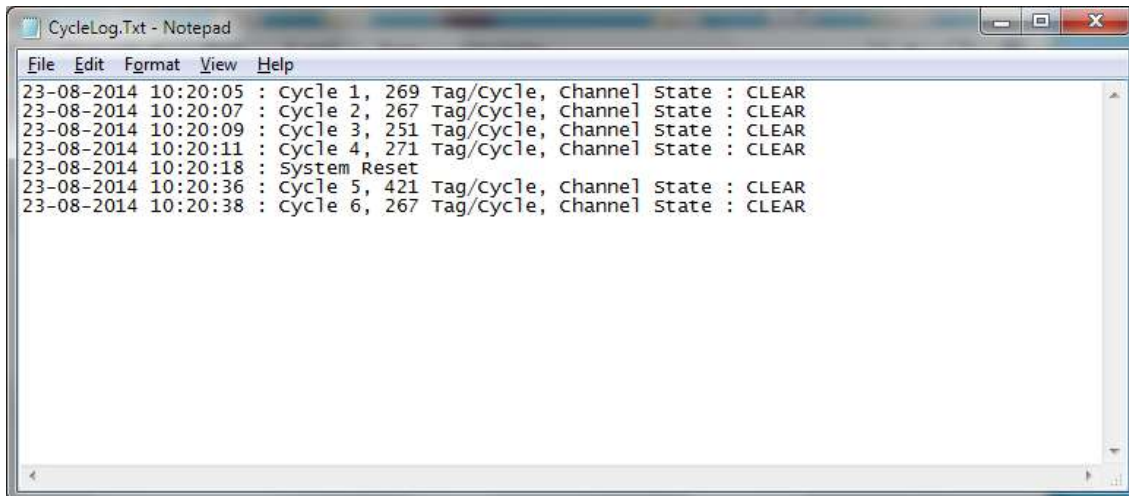

User can **record the received tag data** in CSV or TXT format.

To record the status of the reader, user can tick the checkbox **“Save Tag Log”** in **Inventory mode**.

Input the Storage in **“FileSize (MB)”**, in **“StopAfterFiles”**, in **“Log File Path”**

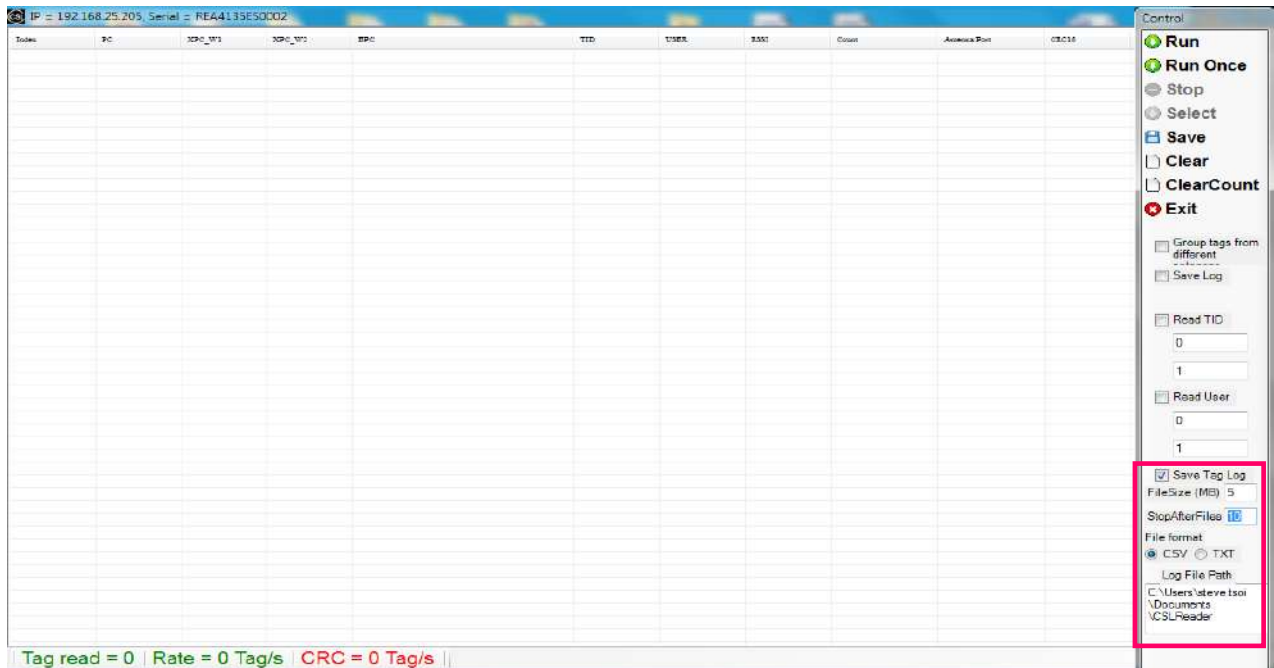

Click **“Run”** to start Inventory. A message box **“Old Tag Files will be deleted”** will be prompted. The previous record will be clear before new tag data record start. Click **“OK”** to continue.

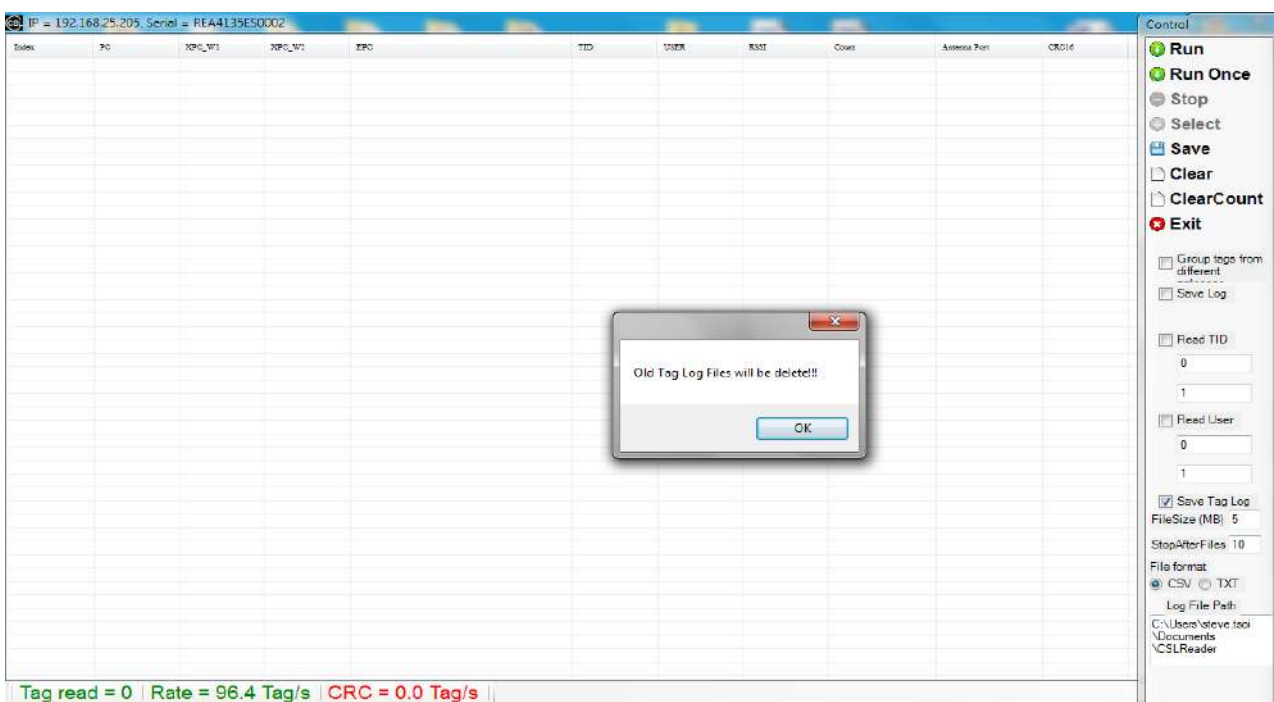

The tag data record will be automatically saved. User can press “**Stop**” to stop the inventory process.

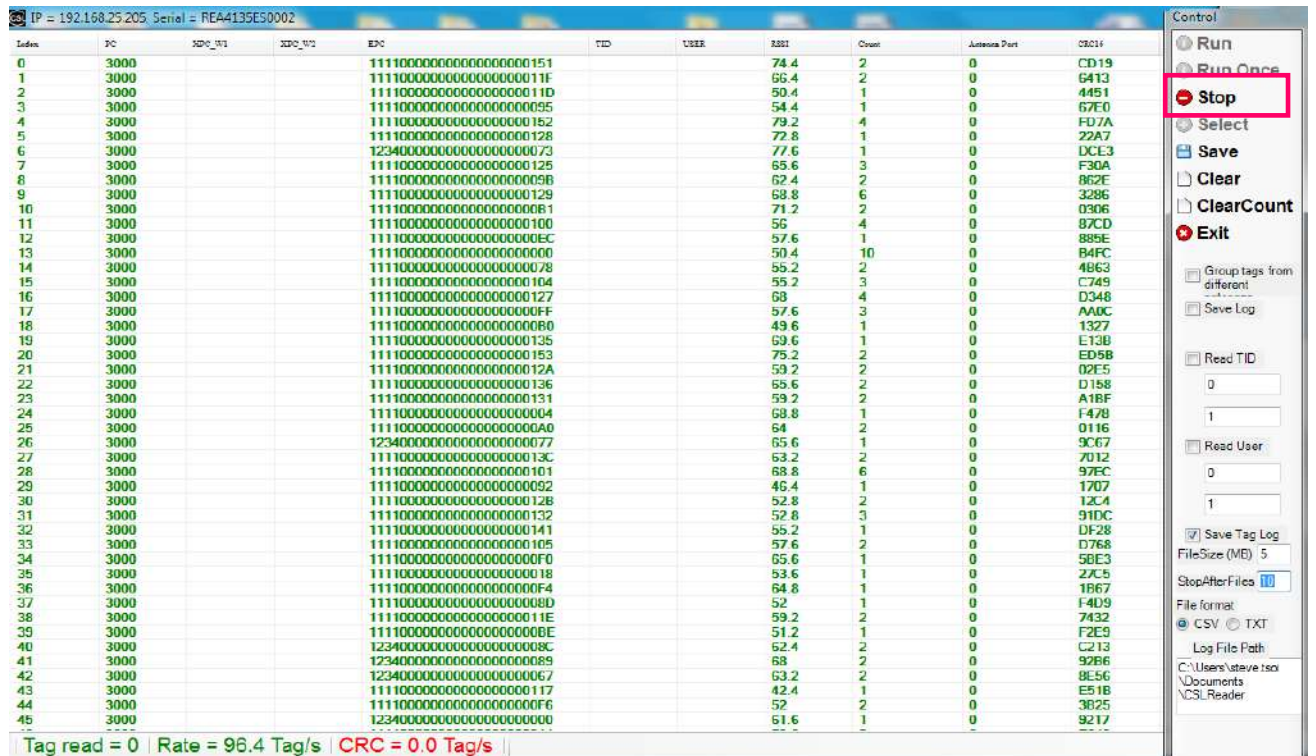

Go to directory “**Libraries > Documents > CSLReader**”, user can find the file which the tag data recorded in “**TagLog1.csv**”.

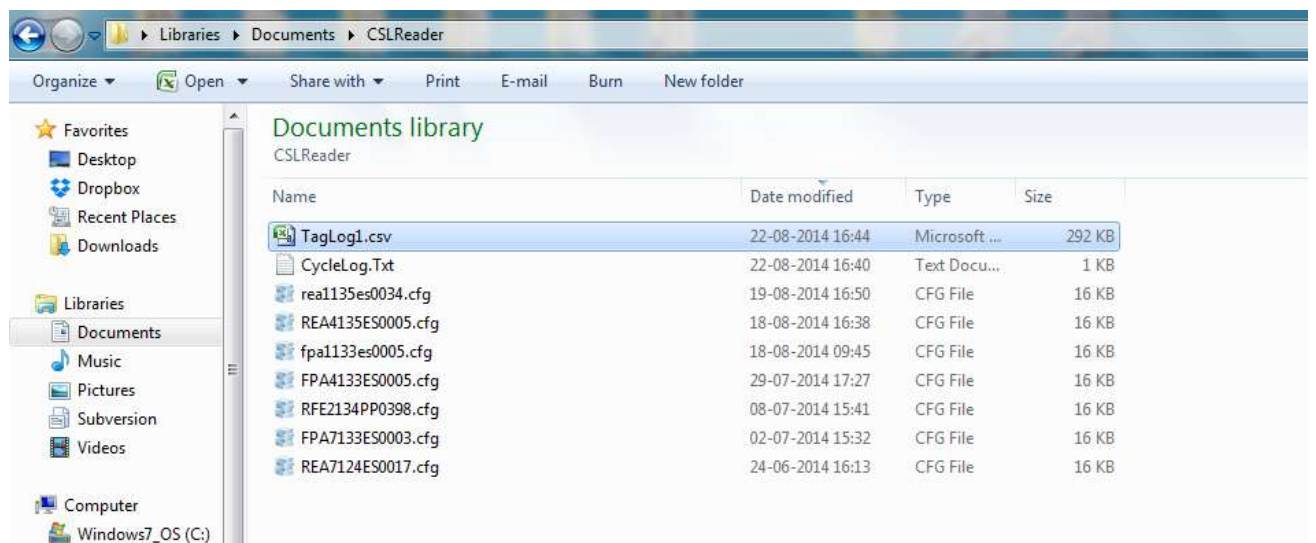

The tag data can be checked in the CSV file: **EPC, Reader ID, Timestamp, RSSI, tag count** and **antenna port**.

	A	B	C	D	E	F	G	H
1	11110000000000000000000000	REA4135ES0002	2014-08-22 16:43:34.596 UTC	72.8	0	0		
2	111100000000000000000000011F	REA4135ES0002	2014-08-22 16:43:34.596 UTC	65.6	0	0		
3	111100000000000000000000011D	REA4135ES0002	2014-08-22 16:43:34.596 UTC	50.4	0	0		
4	1111000000000000000000000000	REA4135ES0002	2014-08-22 16:43:34.612 UTC	54.4	0	0		
5	1111000000000000000000000000	REA4135ES0002	2014-08-22 16:43:34.612 UTC	79.2	0	0		
6	1111000000000000000000000000	REA4135ES0002	2014-08-22 16:43:34.612 UTC	72.8	0	0		
7	1234000000000000000000000000	REA4135ES0002	2014-08-22 16:43:34.612 UTC	77.6	0	0		
8	1111000000000000000000000000	REA4135ES0002	2014-08-22 16:43:34.627 UTC	64	0	0		
9	111100000000000000000000009B	REA4135ES0002	2014-08-22 16:43:34.627 UTC	62.4	0	0		
10	1111000000000000000000000000	REA4135ES0002	2014-08-22 16:43:34.658 UTC	63.2	0	0		
11	11110000000000000000000000B1	REA4135ES0002	2014-08-22 16:43:34.658 UTC	71.2	0	0		
12	1111000000000000000000000000	REA4135ES0002	2014-08-22 16:43:34.674 UTC	62.4	0	0		
13	11110000000000000000000000EC	REA4135ES0002	2014-08-22 16:43:34.674 UTC	57.6	0	0		
14	1111000000000000000000000000	REA4135ES0002	2014-08-22 16:43:34.674 UTC	75.2	0	0		
15	1111000000000000000000000000	REA4135ES0002	2014-08-22 16:43:34.690 UTC	56	0	0		
16	1111000000000000000000000000	REA4135ES0002	2014-08-22 16:43:34.705 UTC	52.8	0	0		
17	1111000000000000000000000000	REA4135ES0002	2014-08-22 16:43:34.736 UTC	79.2	0	2		
18	1111000000000000000000000000	REA4135ES0002	2014-08-22 16:43:34.736 UTC	58.4	0	2		
19	1111000000000000000000000000	REA4135ES0002	2014-08-22 16:43:34.736 UTC	70.4	0	0		

# 8 PC Software Upgrade

## 8.1 PC Demo Application Upgrade

User can visit the CSL website (<http://www.convergence.com.hk>) > Downloads & Support > CS203 to find the latest release software for upgrade of CSL Reader

The screenshot shows the CSL website's 'Downloads & Support' page for the CS203 model. The page includes a navigation menu with options like SOLUTIONS, PRODUCTS, CUSTOM SERVICES, DOWNLOADS & SUPPORT, PARTNERS, NEWS, ABOUT US, and CONTACT. A sidebar on the left lists various product models under 'DOWNLOADS & SUPPORT', with CS203 highlighted. The main content area features a breadcrumb trail (Home > Downloads & Support > CS203) and a heading for 'CS203'. Below this, there are links for 'Download and Support for General User' and 'Download and Support for Developer'. A section titled 'For General User' contains a 'User's Manual' table. This table has three columns: 'File', 'Latest Version', and 'Note'. It lists the 'CS203ETHER Integrated RFID Reader User's Manual' with a 'Latest Version' of '4 Sep 2011' and a 'Note' stating it is the 'User's Manual for CS203ETHER Integrated RFID Reader'. Below this is a 'Demo App' section with another table. This table also has three columns: 'Installers', 'Latest Version', and 'Note'. It lists the 'C# Native Single Reader on Windows OS with User Interface' with a 'Latest Version' of 'Aug 2014' and a 'Note' stating it is a 'Demo App in C# Native'.

File	Latest Version	Note
CS203ETHER Integrated RFID Reader User's Manual	4 Sep 2011	User's Manual for CS203ETHER Integrated RFID Reader

Installers	Latest Version	Note
C# Native Single Reader on Windows OS with User Interface	Aug 2014	Demo App in C# Native,

## 8.2 PC Demo Application Upgrade - For User

1. In the section “Demo App”, check the latest version of Demo Application and download it.

**Demo App**

---

Installers	Latest Version	Note
<a href="#">C# Native Single Reader on Windows OS with User Interface</a>	Aug 2014	Demo App in C# Native, connects to 1 reader
<a href="#">C# Native Multi-Readers on Windows OS using Command Prompt</a>	Aug 2014	Demo App in C# Native, connects to multiple readers
<a href="#">Java Over C++ Single Reader on Windows OS with User Interface</a>	Jan 2014	Demo App in Java Over C++, connects to 1 reader
<a href="#">Java Native (Low Level API) Multi-Readers on Windows OS with User Interface</a>	Jan 2014	Demo App in Java Native, connects to multiple readers
<a href="#">CSL Adaptor (Multi-Readers) for Rifidi Edge Server on Window OS in Java (Low Level API)</a>	Jul 2014	Adaptor for Rifidi Edge Server, connects to multiple readers
<a href="#">C (Low Level API) Multi-Readers on Linux OS using Command Prompt</a>	Jul 2014	Demo App in C on Linux OS, connects to multiple readers

**Special Notes**

---

Files	Latest Version	Note
<a href="#">Ethernet Connection Problems and Handling Methods</a>	Mar 2014	



“CSL products are high performance, easy to use, and flexible for custom programming.”



<b>SOLUTIONS</b>	<b>PRODUCTS</b>	<b>CUSTOM SERVICES</b>	<b>DOWNLOADS &amp; SUPPORT</b>	<b>PARTNERS</b>	<b>NEWS</b>	<b>ABOUT US</b>	<b>CONTACT</b>
------------------	-----------------	------------------------	--------------------------------	-----------------	-------------	-----------------	----------------

**DOWNLOAD & SUPPORT – INSTALLER – CSHARP – SINGLE READER**

Home » Download & Support – Installer – CSharp – Single Reader

**Download & Support – Installer – CSharp – Single Reader**

**C# Native Demo App – Single Reader**

Installer	Version	Note
<a href="#">CSL RFID Demo App 3.1.88_InstallerOnly.zip</a>	15 Aug 2014 (Latest)	<a href="#">CS Library 3.0.58 release notes</a>
<a href="#">CSL RFID Demo App 3.1.87_InstallerOnly.zip</a>	8 Aug 2014	<a href="#">CS Library 3.0.56 release notes</a>

## 2. Uninstall the original Demo App previous installed in PC.

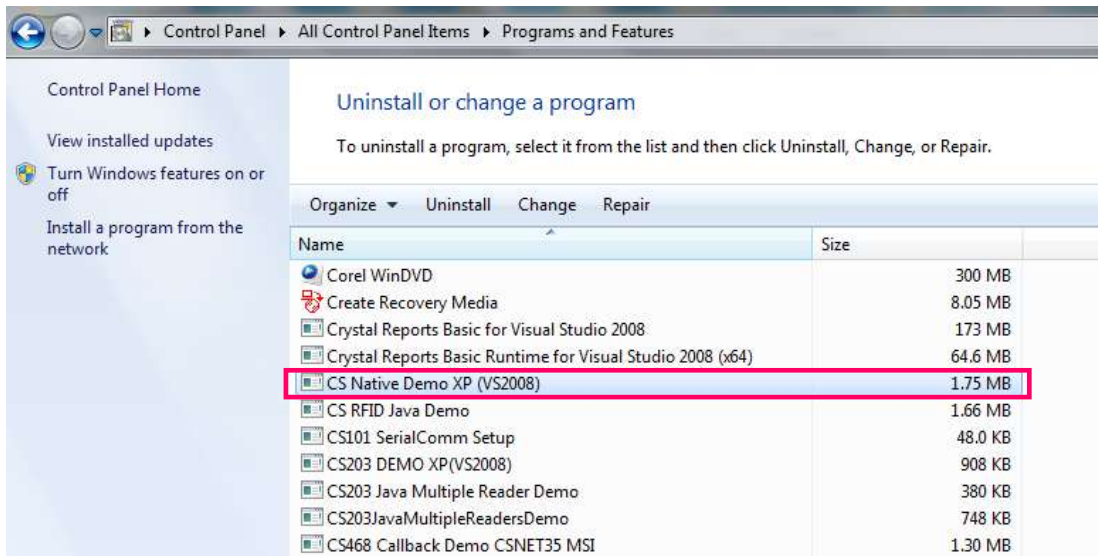

## 3. Unzip and install the latest Demo App.

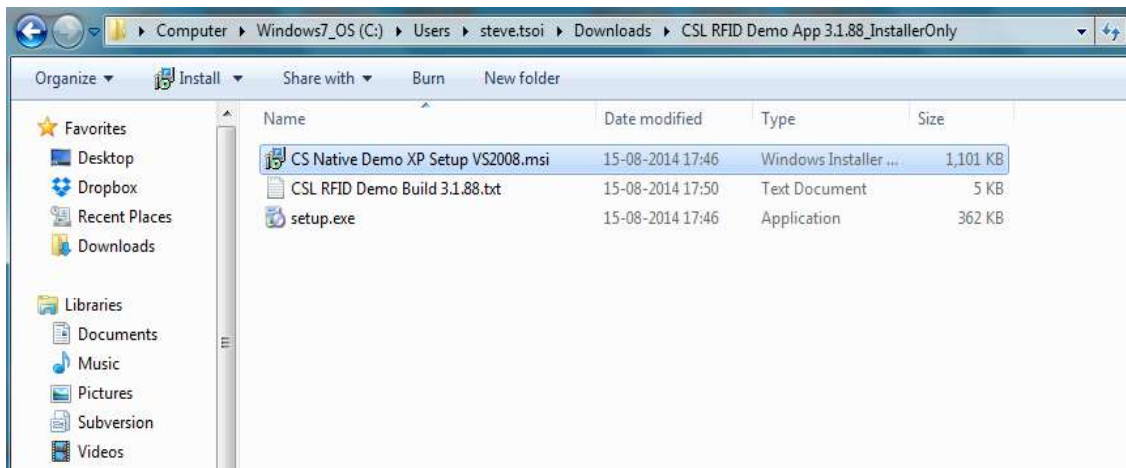



### 8.3 PC Demo Application Upgrade - For Developer

1. In the section “Software Development Kit”, check the latest version of SDK and download it.



**For Developer**

**Software Development Kit**

SDK	Latest Version	Note
<a href="#">C# Native Single Reader on Windows OS with User Interface</a>	Aug 2014	Source Code, Libraries, Binaries and Reference Manual for Single Reader in C#
<a href="#">C# Native Multi-Readers on Windows OS using Command Prompt</a>	Aug 2014	Source Code, Libraries, Binaries and Reference Manual for Multiple Readers in C#
<a href="#">Java Over C++ Single Reader on Windows OS with User Interface</a>	Feb 2014	Source Code, Libraries, Binaries and Reference Manual for Single Reader in Java
<a href="#">Java Native (Low Level API) Multi-Readers on Windows OS with User Interface</a>	Feb 2014	Source Code, Libraries, Binaries and Reference Manual for Multiple Readers in Java
<a href="#">C (Low Level API) Multi-Readers on Linux OS using Command Prompt</a>	Jul 2014	Source Code for Multi-Readers in C on Linux OS



“CS101 reads twice as far at half the price of competitors.”



简体



---

SOLUTIONS
PRODUCTS
CUSTOM SERVICES
DOWNLOADS & SUPPORT
PARTNERS
NEWS
ABOUT US
CONTACT

**DOWNLOAD & SUPPORT – SDK – CSHARP – SINGLEREADER**

Home » Download & Support – SDK – CSharp – SingleReader

[Download & Support – SDK – CSharp – SingleReader](#)

**C# Native SDK – Single Reader**

---

Software Development Kit	Version	Note
<a href="#">CSL RFID Demo Build 3.1.88.zip</a>	15 Aug 2014 (Latest)	CS Library 3.0.58 <a href="#">release notes</a>
<a href="#">CSL RFID Demo Build 3.1.87.zip</a>	7 Aug 2014	CS Library 3.0.56 <a href="#">release notes</a>

2. Unzip and check the “Release Libraries”.

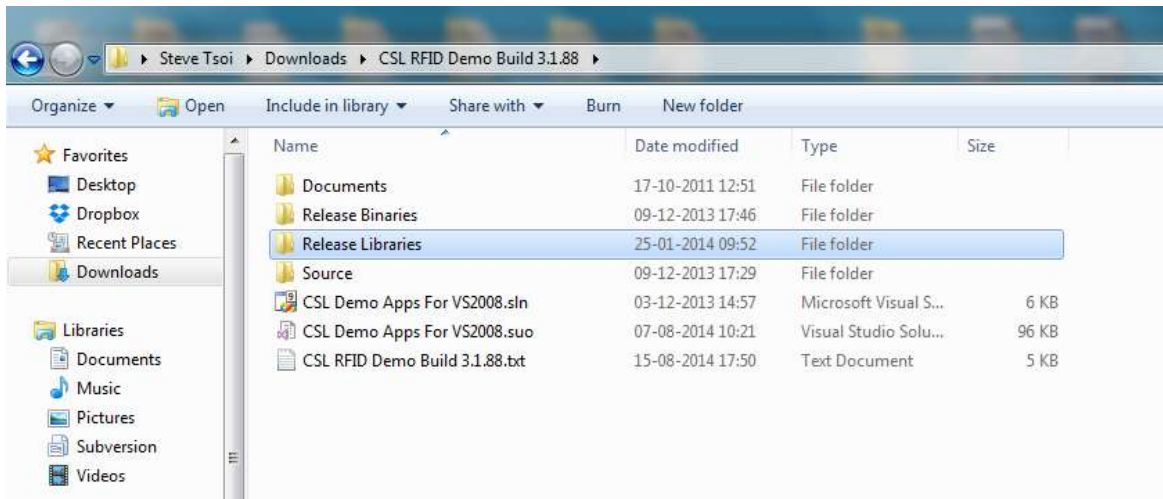

3. Copy the SDK Library folders inside the folder “Release Libraries” and replace the folders in “Release Libraries” in current Developer’s project.

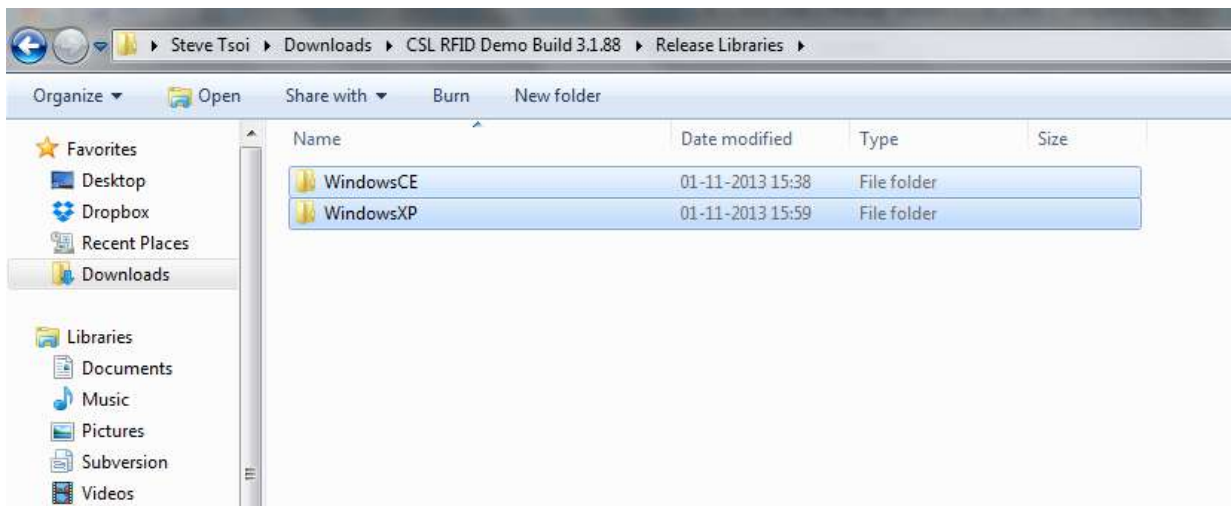

4. Open the Developer's project in Microsoft Visual Studio. Rebuild the project with latest SDK libraries.

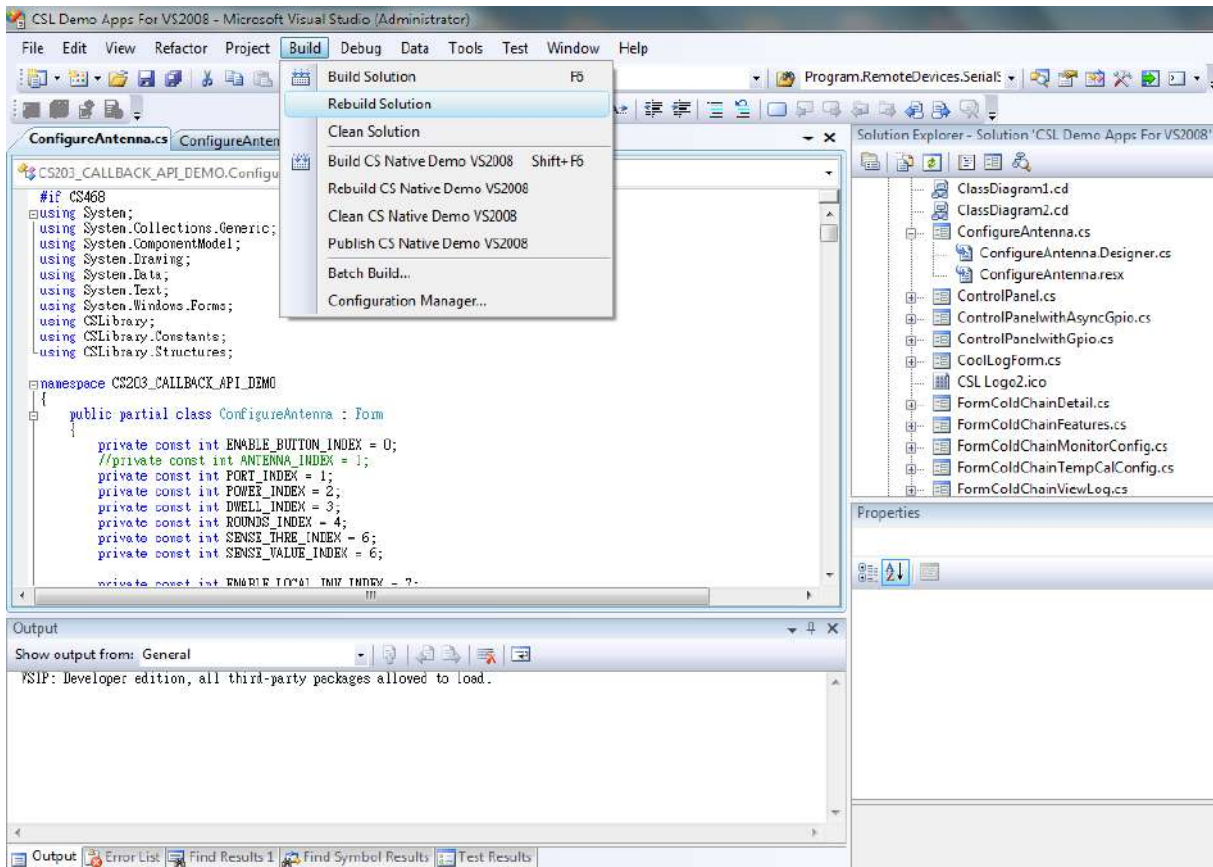

## 9 Software Development Kit for Developer

### 9.1 Introduction

This chapter will describe the details about the CS203 Software Development Kit for Developer. Software developers can refer to this demo program for programming

- High Level API and Low Level API
- C# / Java / C
- Single Reader / Multit-Reader

### 9.2 Program Structure

The Demo Application folder consists of the following directories:

CS203 CALLBACK API CUST	Source code of the Multi-function Demo Application program (e.g. inventory, read and write etc...)
CS203 GPIO	Source code to demonstrate the GPIO and IP setting function of the reader
CSLibrary	All necessarily dll library files
DEMO	Installer of the Multi-function Demo Application program (e.g., inventory, read and write etc...)
Document	User Documents: API Library manual, User Manual, etc.

## 9.3 Build Project Requirements

To run the CS203 application programs, the PC must have the following software installed:

- 1) Dot Net Framework 3.5 or above

It is available in Windows 7 or above and it is downloadable from Microsoft website.

The software can be downloaded from CSL website (<http://www.convergence.com.hk/>) > Downloads & Support area.

### **SDK - "C# Native Single Reader on Windows OS with User Interface" and "C# Native Multi-Readers on Windows OS using Command Prompt":**

To build demo application successfully, you need to install Microsoft Visual Studio 2008 (with Visual C# component) or above. For more detailed information, please go to Microsoft webpage (<http://msdn.microsoft.com/en-us/vstudio/default.aspx>).

### **SDK - "Java Over C++ Single Reader on Windows OS with User Interface" and "Java Native (Low Level API) Multi-Readers on Windows OS with User Interface":**

To build demo application successfully, you need to install NetBeans IDE and Java SE Development Kit 7 Update 51 or above. For more detailed information, please go to Oracle's webpage

(<http://www.oracle.com/technetwork/java/javase/downloads/jdk-7-netbeans-download-432126.html>).

### **SDK - "C (Low Level API) Multi-Readers on Linux OS using Command Prompt":**

To build demo application successfully, you need to install Ubuntu with GCC compiler. For more detailed information, please go to Ubuntu's webpage

(<http://www.ubuntu.com/download/desktop>).

# 10 Reader Firmware Upgrade

## 10.1 Reader Connection

Before doing firmware upgrade, please ensure the reader is connected properly to PC via an **Ethernet Switch / Router** and can be operated using CSL Demo App provided. (e.g. run "Inventory" in CSL Demo App). **DO NOT DIRECT CONNECT PC TO READER.**

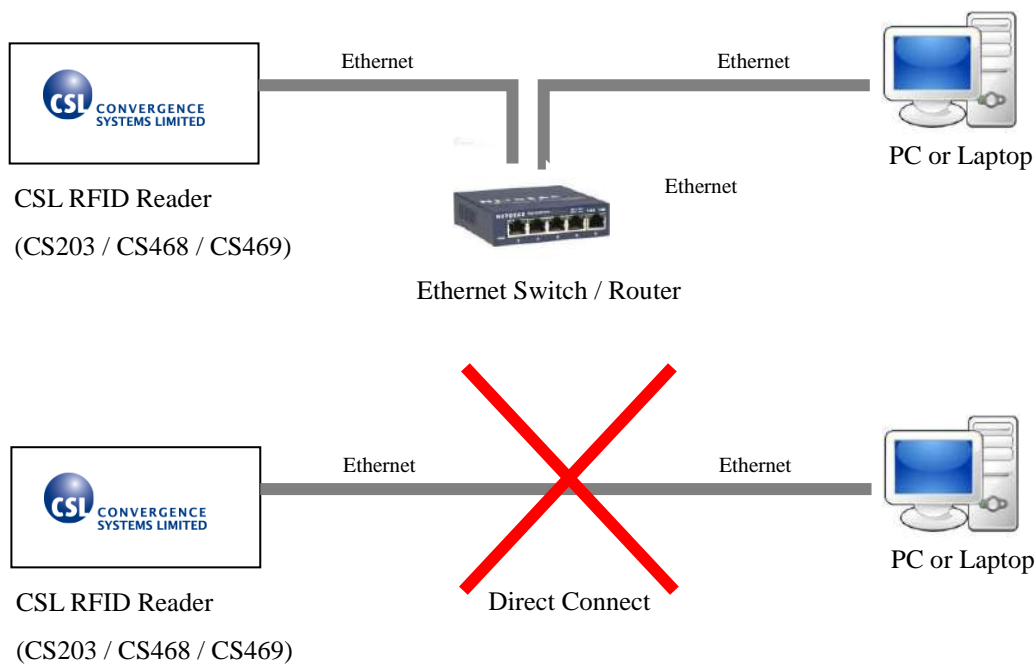

If the firmware upgrade fails during the process, user must **POWER OFF** and **POWER ON** the reader again before redoing firmware upgrade.

## 10.2 Firmware Upgrade Procedure Overview

CSL CS203, CS468 and CS469 Readers have 1 RFID Processor and 1 Network Processor for RFID application and network application. The application firmware can be upgradable via PC software provided (RFID FwUpgrade X.X.XX.exe).

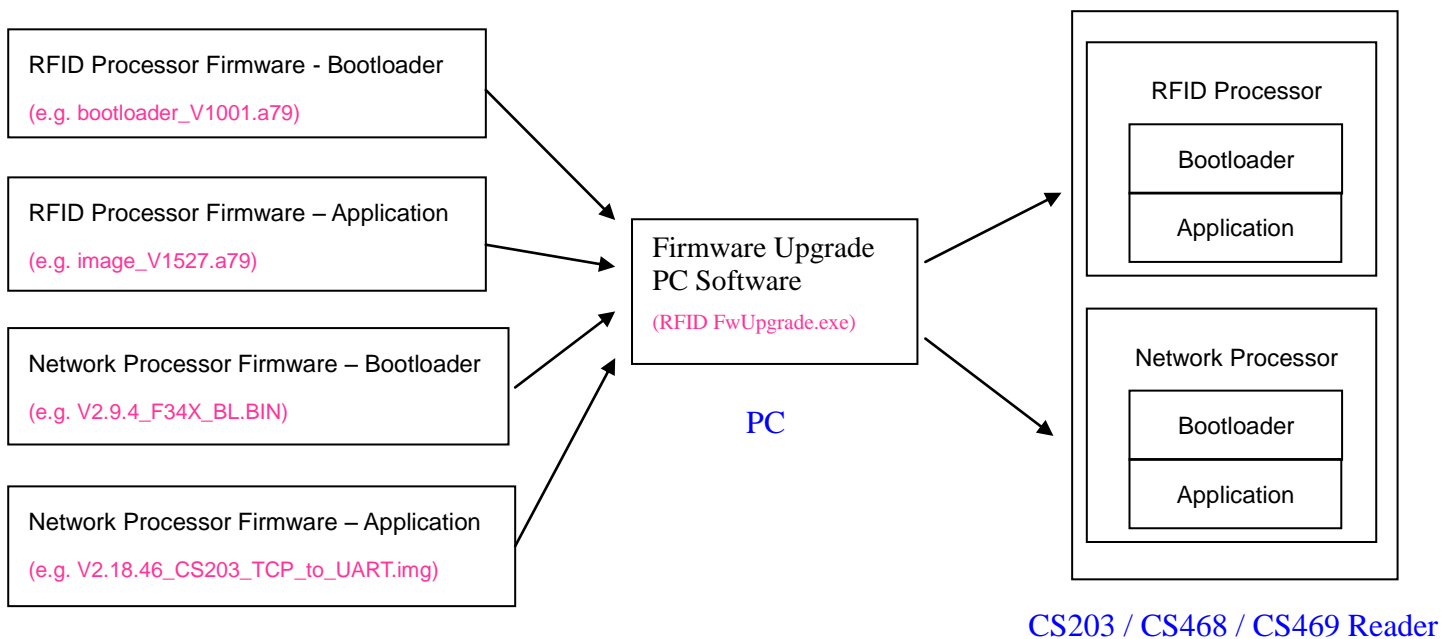

Firmware files

The Firmware Compatibility Table shows that current CSL RFID readers with RFID Application version 1.3.xx and v1.4.xx do not include RFID Bootloader. Therefore if user wants to do firmware upgrade of RFID Application from **v1.3.xx / v1.4.xx** to **v1.5.xx**, user must install the RFID Bootloader to the reader before upgrading the RFID Application to the latest version (v1.5.xx or after).

RFID App	RFID Bootloader	Network Processor App	Network Processor Bootloader
<b>v1.3.xx</b>	<b>No Bootloader</b>	<b>All, up to v2.18.46</b>	<b>All, up to v2.9.4</b>
<b>v1.4.xx</b>	<b>No Bootloader</b>	<b>All, up to v2.18.46</b>	<b>All, up to v2.9.4</b>
<b>v1.5.xx</b>	<b>V1.0.00 / v1.0.01</b>	<b>v2.18.46</b>	<b>v2.9.4</b>

**Firmware version for RFID Reader CS203 / CS468 / CS469**

The flow diagram for Firmware Upgrade procedure

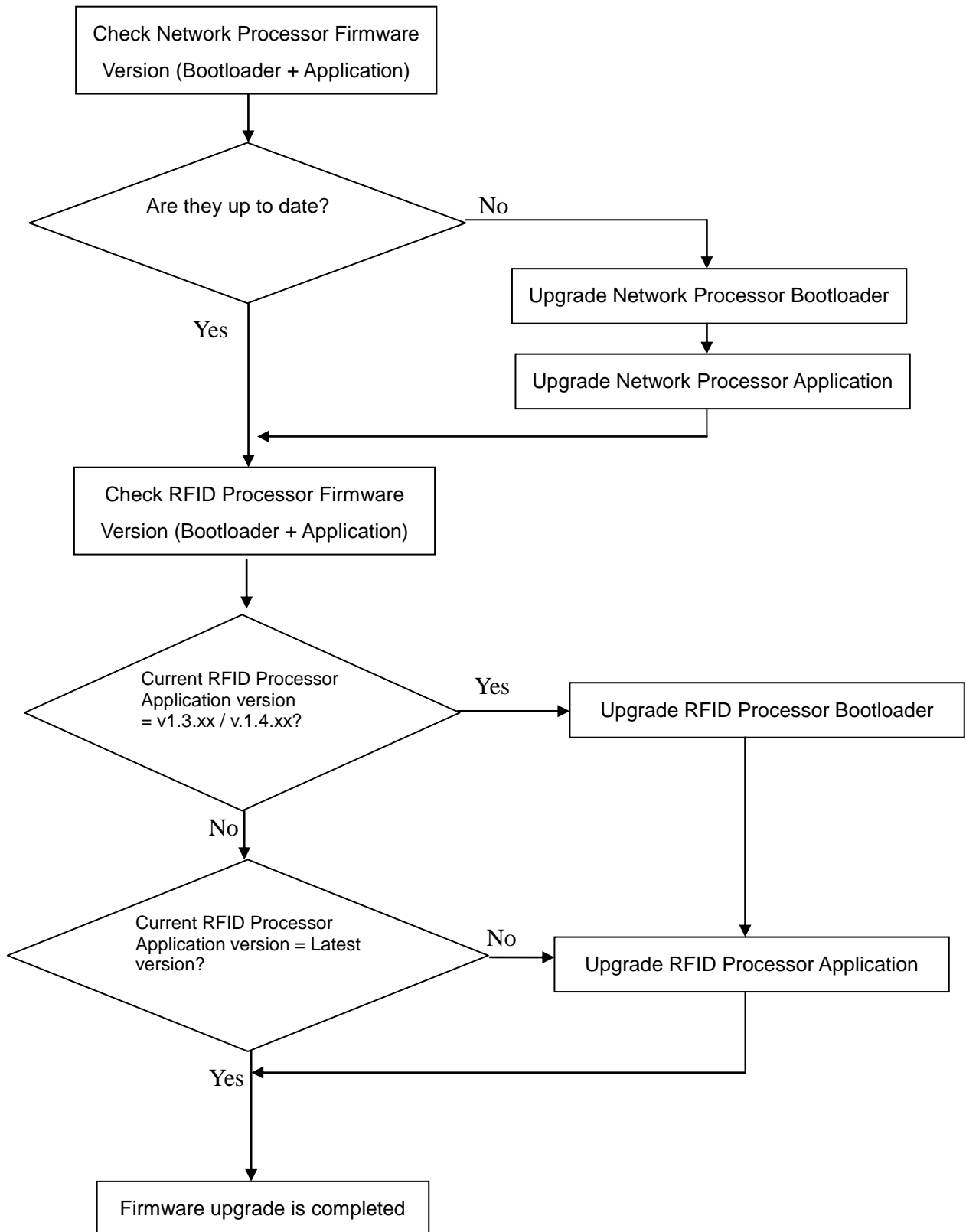



### 10.3 Network Processor Firmware Upgrade Procedure

1. Please download the latest Firmware Upgrade tool from CSL website  
(<http://www.convergence.com.hk/download-support-firmware-upgrade-tool/>). The latest version is "RFID FwUpgrade2.0.27.zip".
2. Download the latest bootloader and application firmware from "Firmware - Network Processor Bootloader" and "Firmware - Network Processor Application".

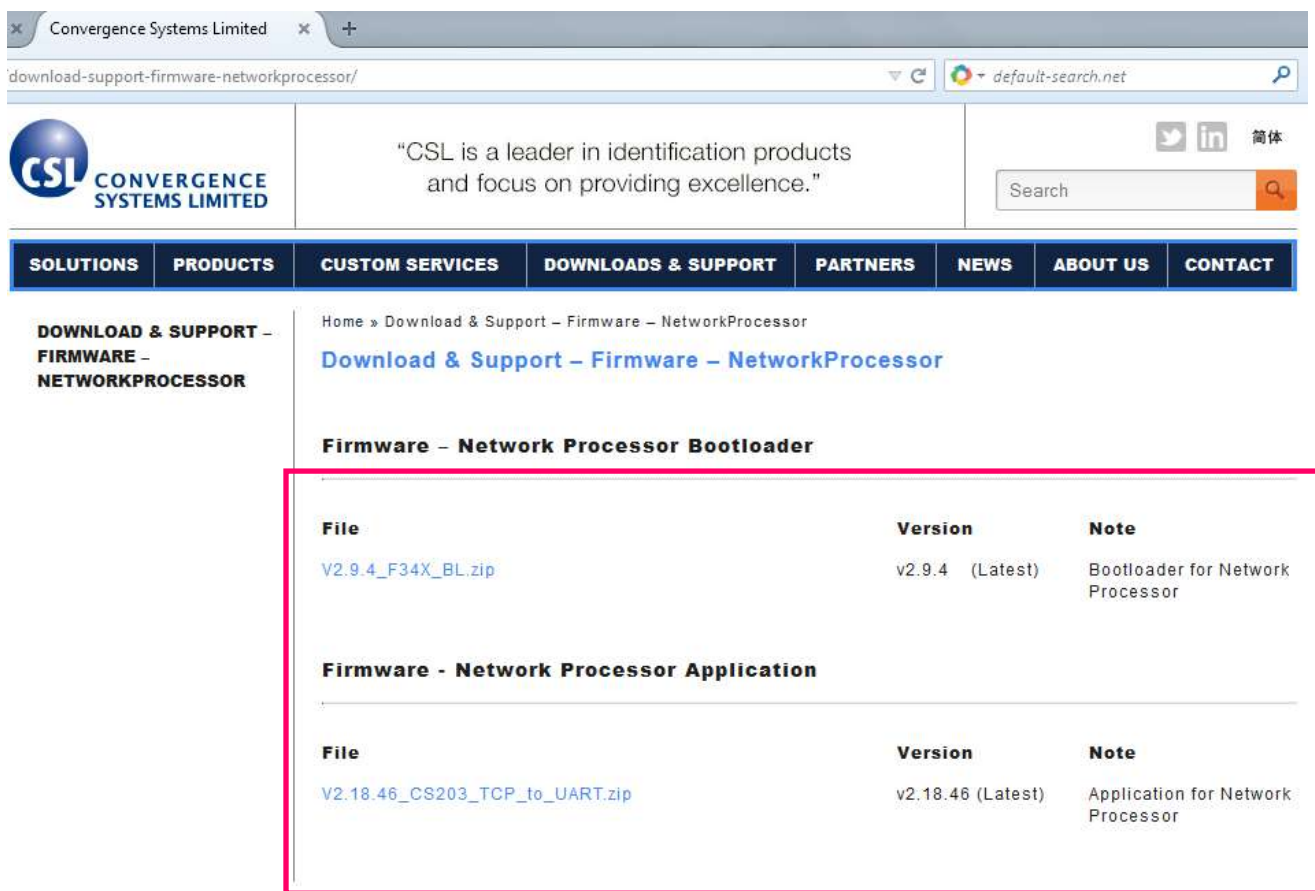

### 3. Unzip "RFID FwUpgrade2.0.27.zip".

Run "RFID FwUpgrade.exe" for CSL reader is connected to PC via USB or Ethernet.

"RFID FwUpgrade\_Usb.exe" is used for CSL reader is connected to PC via USB only. Do not connect via Ethernet when using "RFID FwUpgrade\_Usb.exe"

"RFID FwUpgrade\_Net.exe" is used for CSL reader is connected to PC via Ethernet only. Do not connect via USB when using "RFID FwUpgrade\_Net.exe"

**Please run the exe file by double clicking the file within this directory only.**

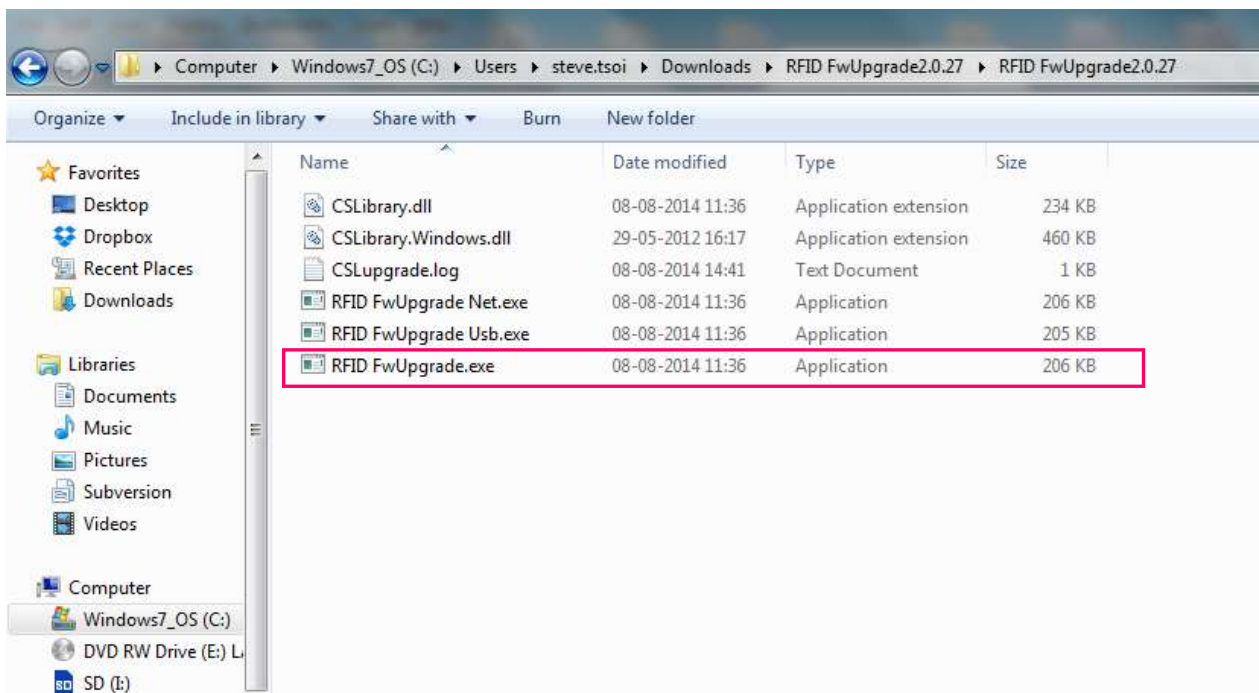

4. Click **[Search]** to check the target reader.

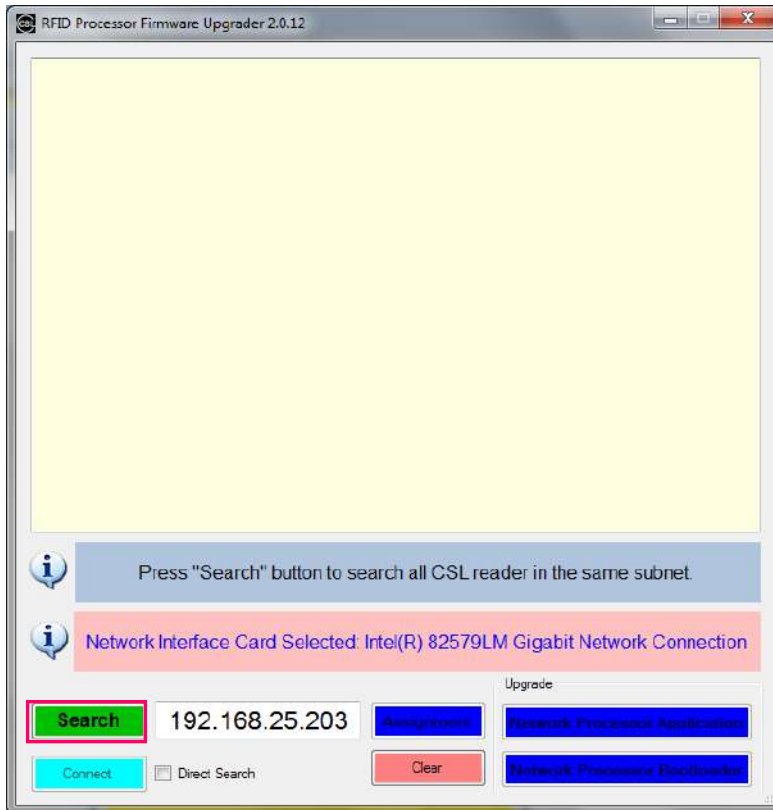

5. Click to select target device in the list. Click **[Network Processor Bootloader]**.

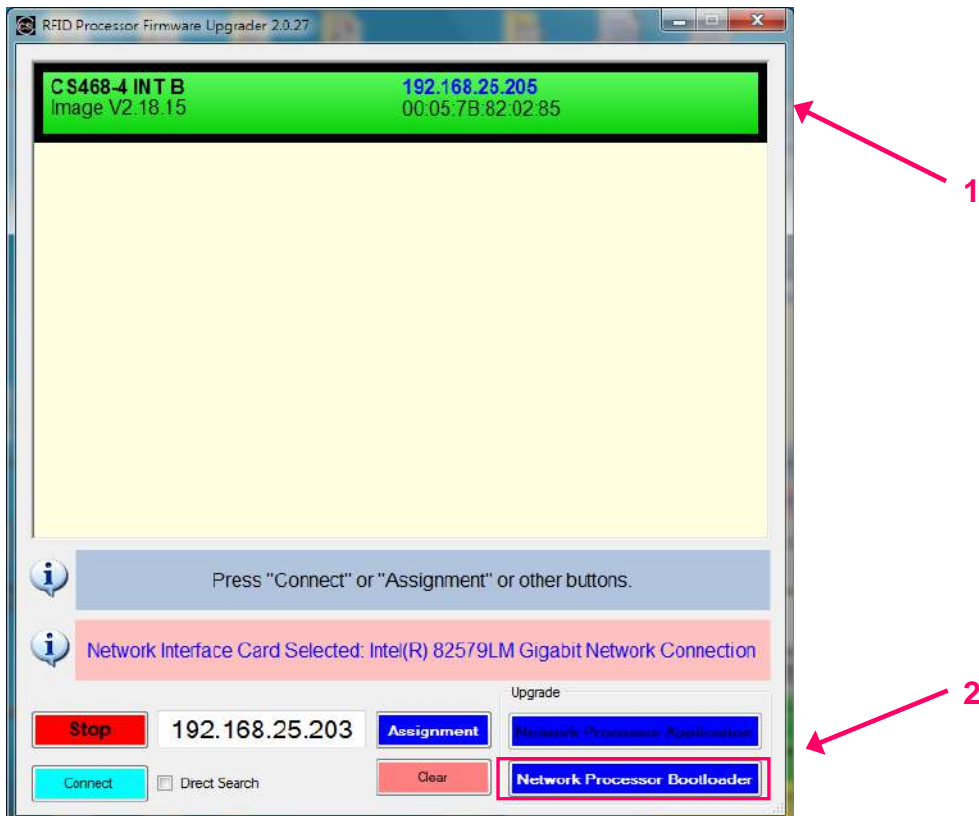

6. Choose the latest Network Processor Bootloader file downloaded from website.

Click **[Open]** to confirm.

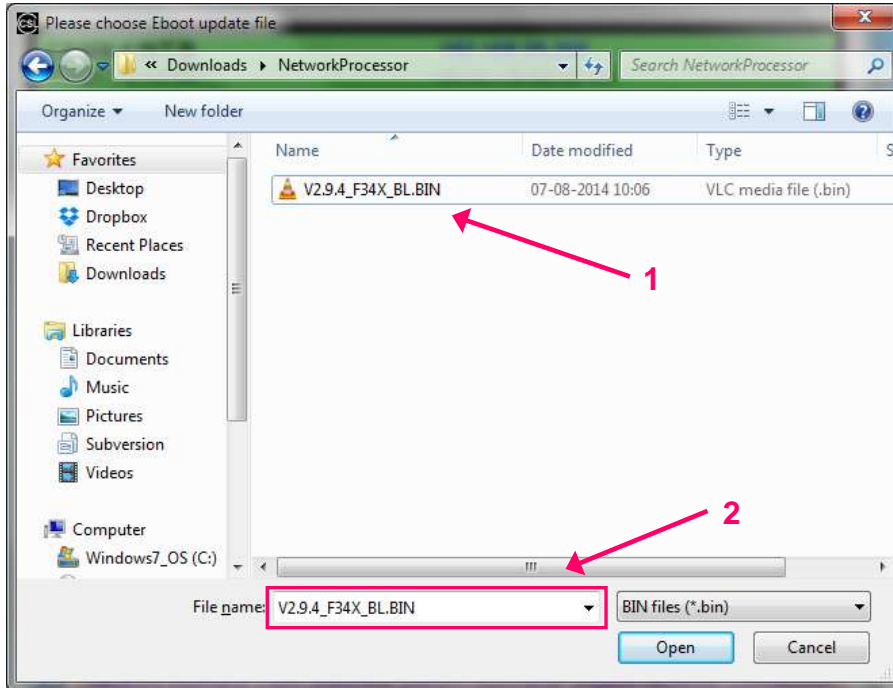

7. The Network Processor Bootloader update process starts.

Press **[OK]** when firmware update process finished

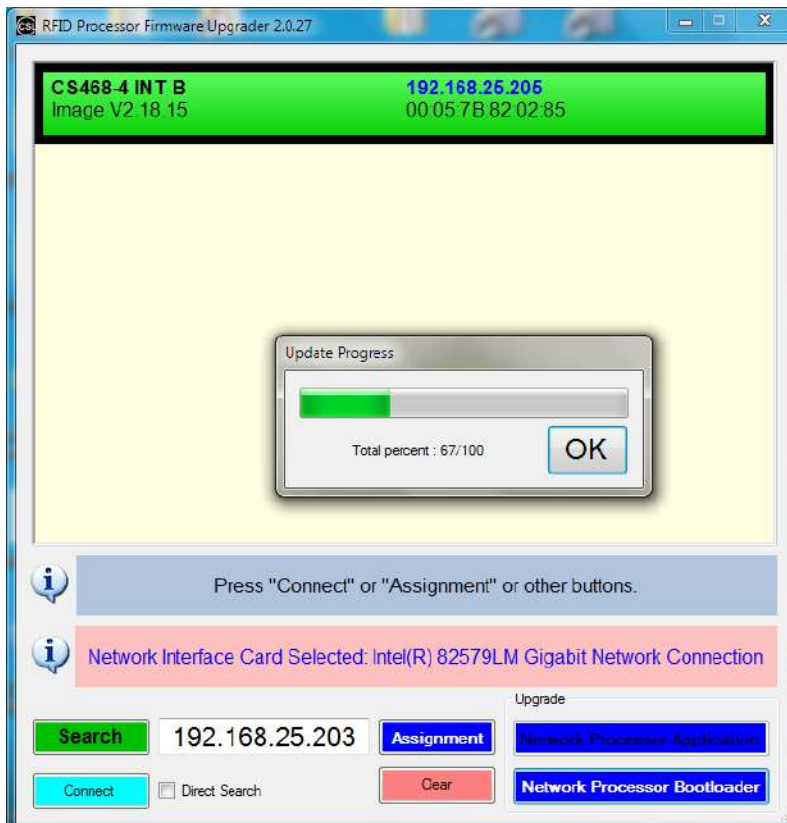

8. The background colour of the target reader in the list is changed from green to yellow.

Click to select the target reader again.

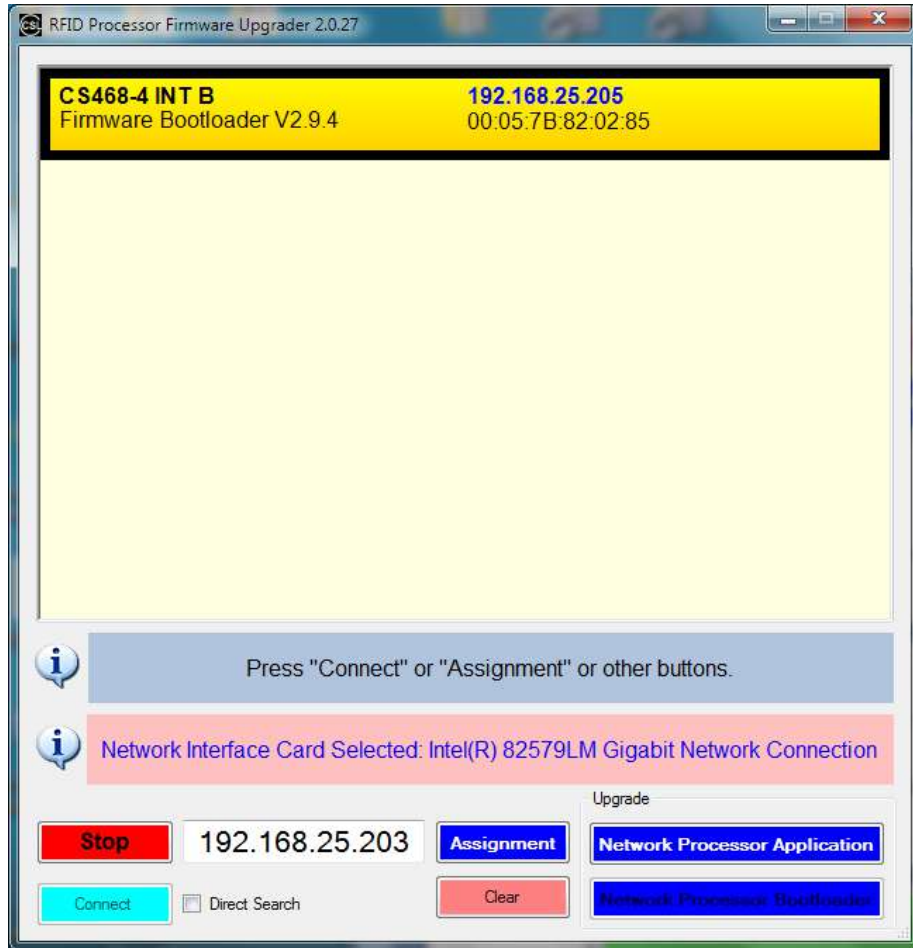

- 9. **If original Network Processor App version is V2.18.4 or after, you can IGNORE this step and jump to next step.**

If original Network Processor App version is old and is **V2.18.3 or before**, after upgrading the bootloader, the IP, subnet and Gateway table will be messed up. You need to correct that.

Press **[Assignment]** button and change the incorrect IP, subnet and gateway back such that it will match your PC. After that, continue with the next step of installing the Network Processor App.

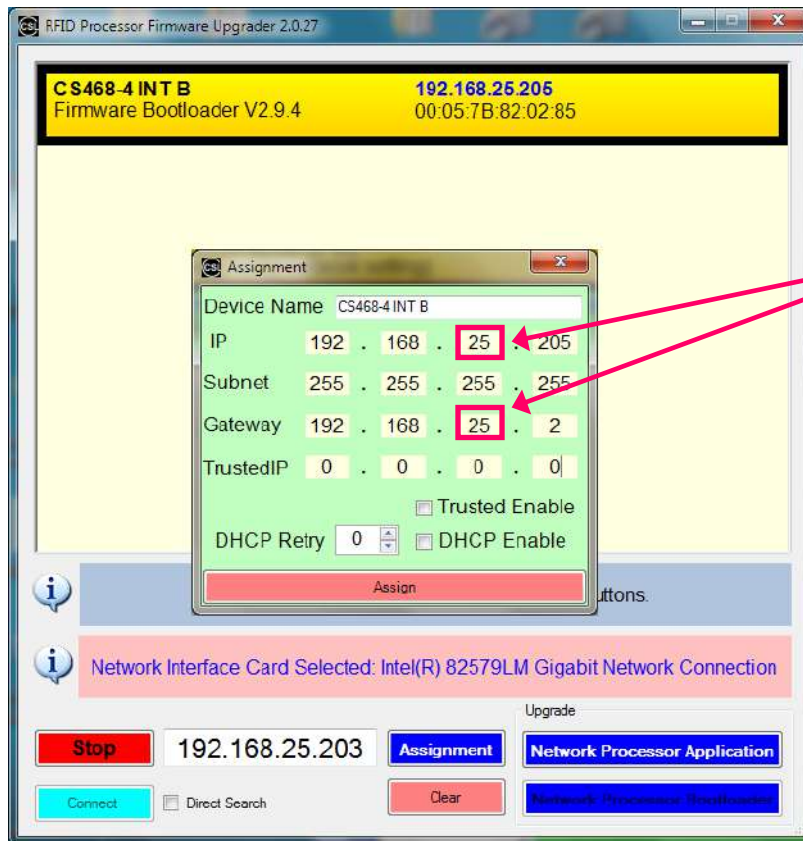

Subnet Mask value

10. Press **[Network Processor Application]**

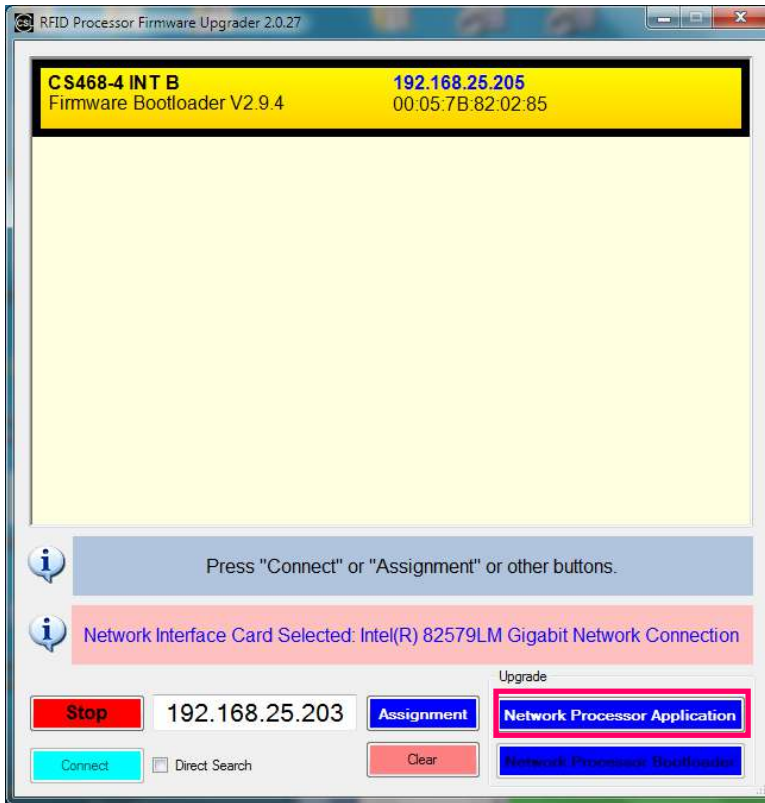

11. Choose the latest Network Processor application file downloaded from CSL website. Click **[Open]** to confirm and start.

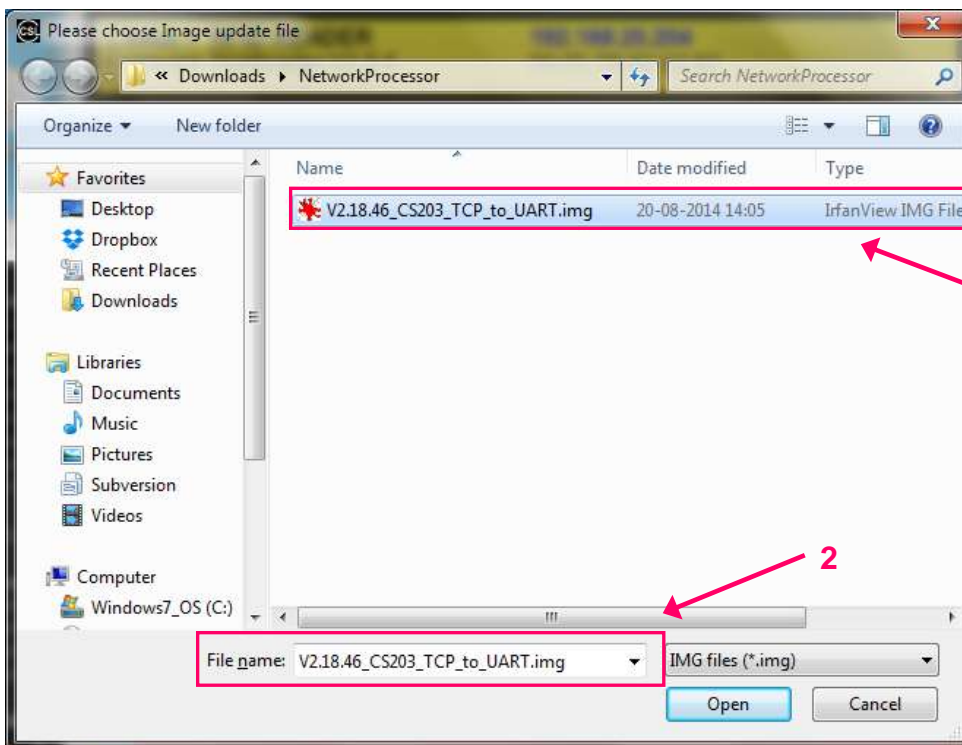

12. The Network Processor application update process starts.

Press **[OK]** when firmware update process finished.

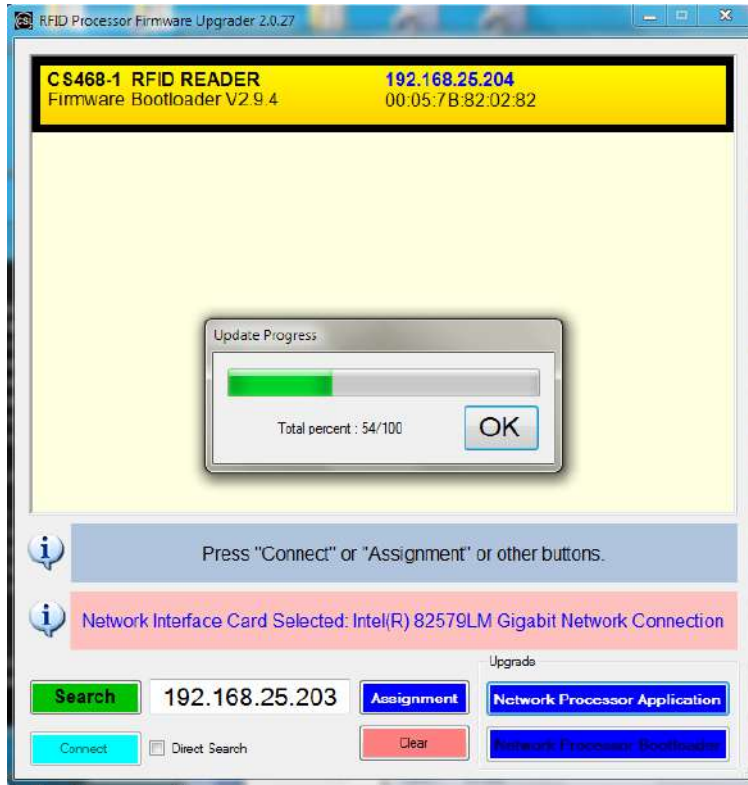

13. The Network Processor application firmware is updated to the latest version.

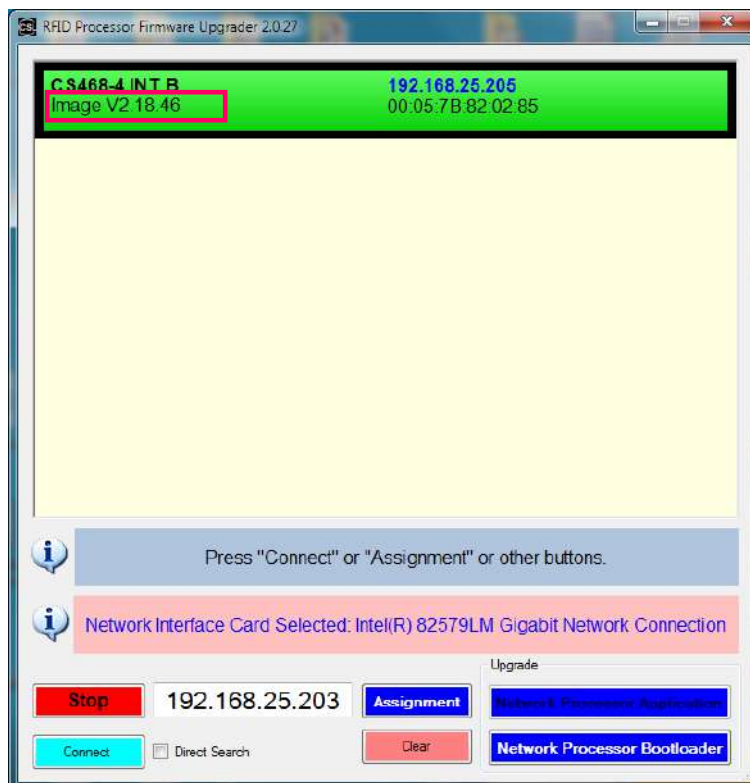



## 10.4 RFID Processor Firmware Upgrade Procedure

Use **MUST** upgrade the firmware of Network Processor to the latest version before upgrade firmware of RFID Processor. Please follow the chapter “Network Processor Firmware Upgrade Procedure” in this document to do firmware upgrade for Network Processor.

### 10.4.1 Procedure for CSL reader with RFID Processor App version 1.3.xx or 1.4.xx

1. User must check the RFID Firmware version before doing RFID Firmware upgrade. **If the RFID Firmware Vers is 1.5.xx, please refer to section “4.2 Procedure for CSL reader with RFID Firmware App 1.5.xx”.**



2. Please download the latest Firmware Upgrade tool from CSL website. The latest version is "RFID FwUpgrade2.0.27.zip".

- Download the latest bootloader and application file for RFID Processor from “Firmware - RFID Processor Bootloader” and “Firmware - RFID Processor Application”.

Home » Download & Support – Firmware – RFIDProcessor

**Download & Support – Firmware – RFIDProcessor**

**Firmware – RFID Processor Bootloader**

File	Version	Note
<a href="#">bootloader_V1001.a79</a>	v1.0.1 (Latest)	Only need if your firmware is v1.3.xx or v1.4.xx

**Firmware – RFID Processor Application**

File	Version	Note
<a href="#">image_V1527.a79</a>	v1.5.27 (Latest)	Fix write error
<a href="#">image_V1526.a79</a>	v1.5.26	Add Ucode 7 parallel encoding
<a href="#">image_V1525.a79</a>	v1.5.25	

#### 4. Unzip "RFID FwUpgrade2.0.27.zip".

Run "RFID FwUpgrade.exe" for CSL reader is connected to PC via USB or Ethernet.

"RFID FwUpgrade\_Usb.exe" is used for CSL reader is connected to PC via USB only. Do not connect via Ethernet when using "RFID FwUpgrade\_Usb.exe"

"RFID FwUpgrade\_Net.exe" is used for CSL reader is connected to PC via Ethernet only. Do not connect via USB when using "RFID FwUpgrade\_Net.exe"

**Please run the exe file by double clicking the file within this directory only.**

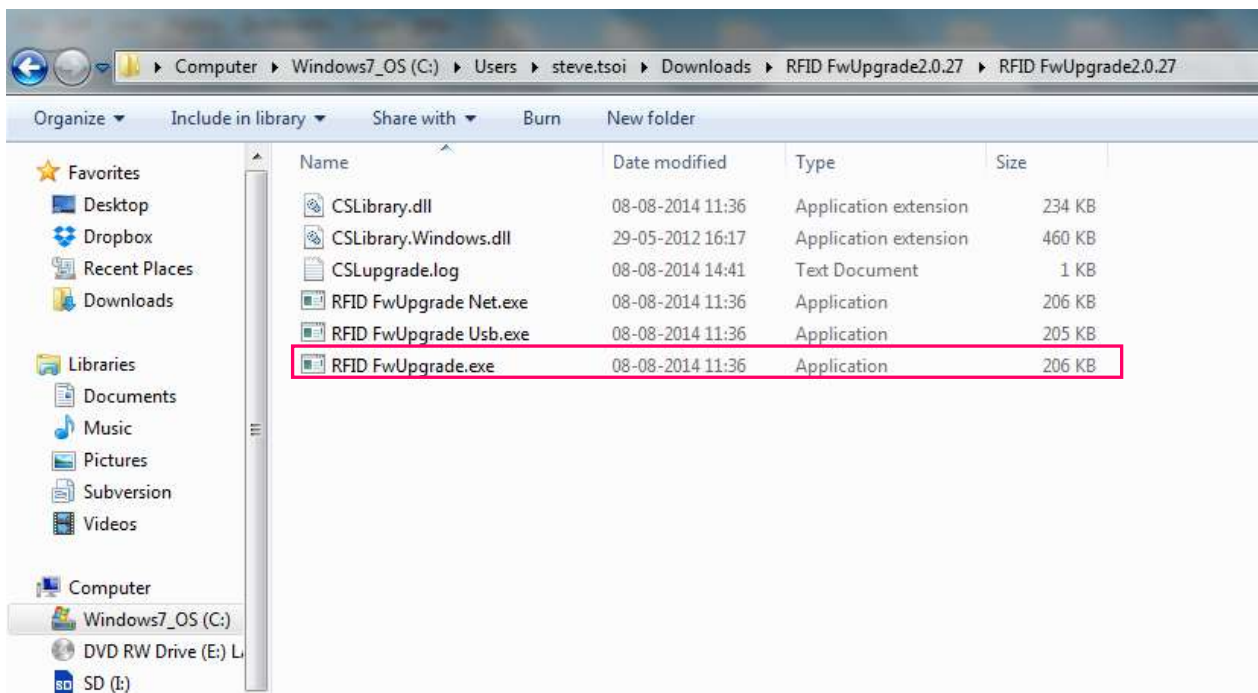

5. Click **Search** to check the target reader

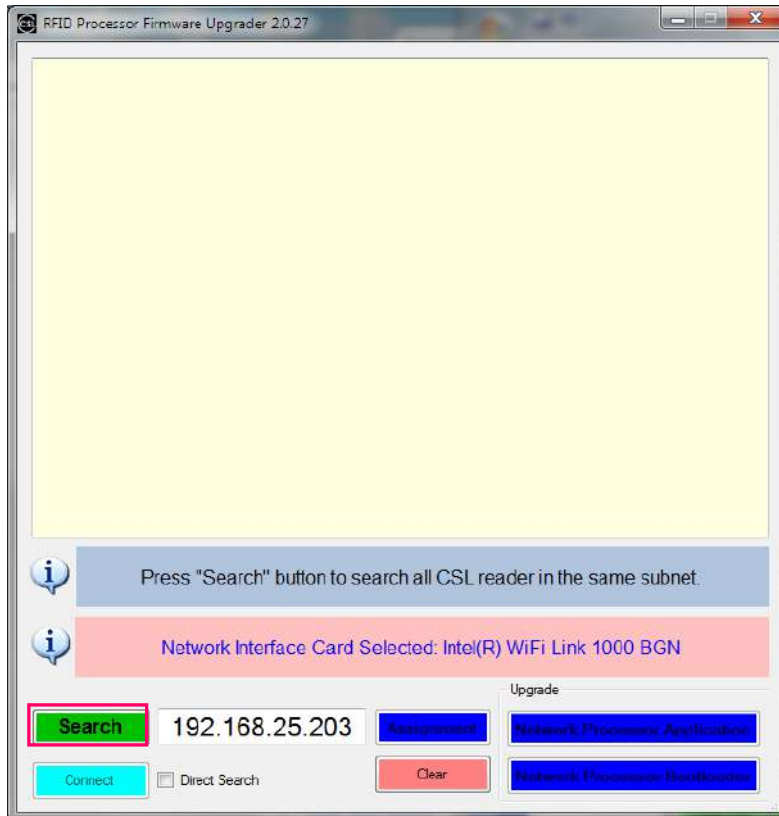

6. Choose target device in the list. Click [**Connect**] to connect to the target reader.

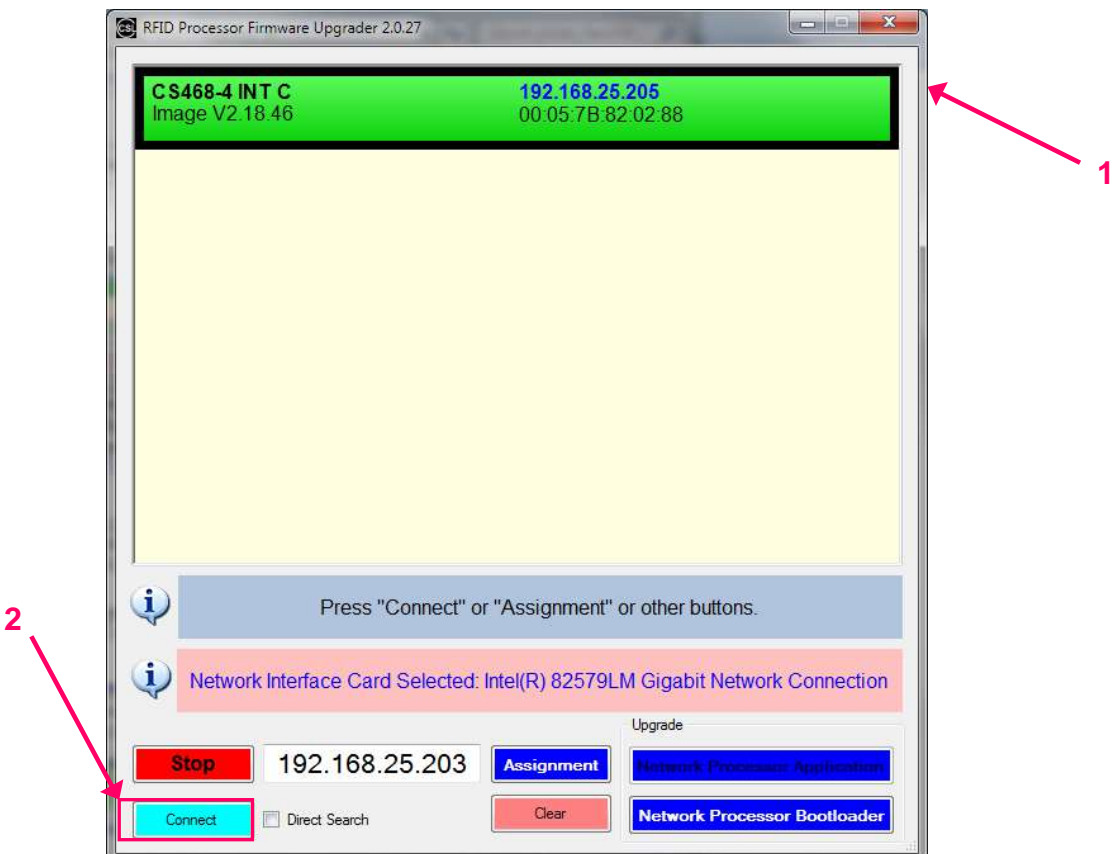

7. Check the current version of the firmware. Click **[Open]**.

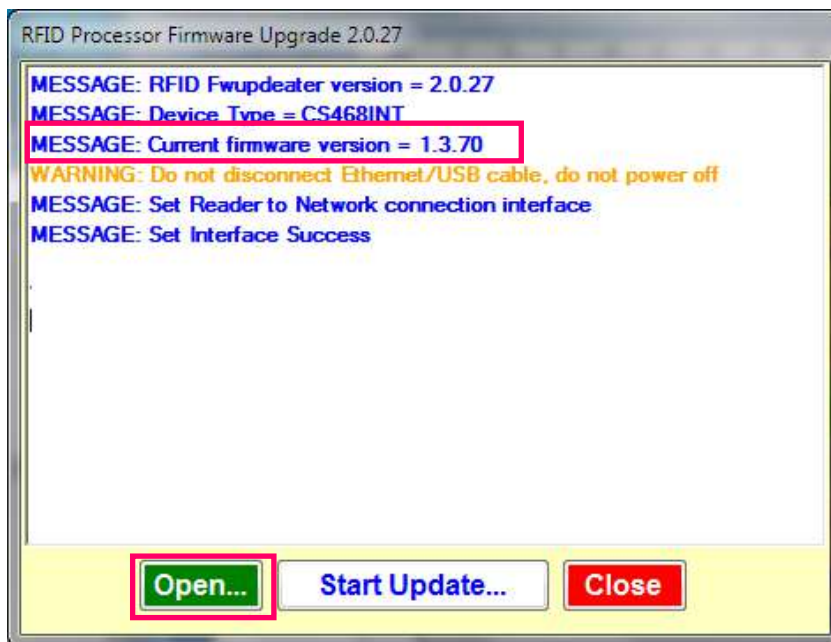

8. Choose the RFID bootloader firmware file “**bootloader\_V1001.a79**”.

Click **[Open]** to confirm.

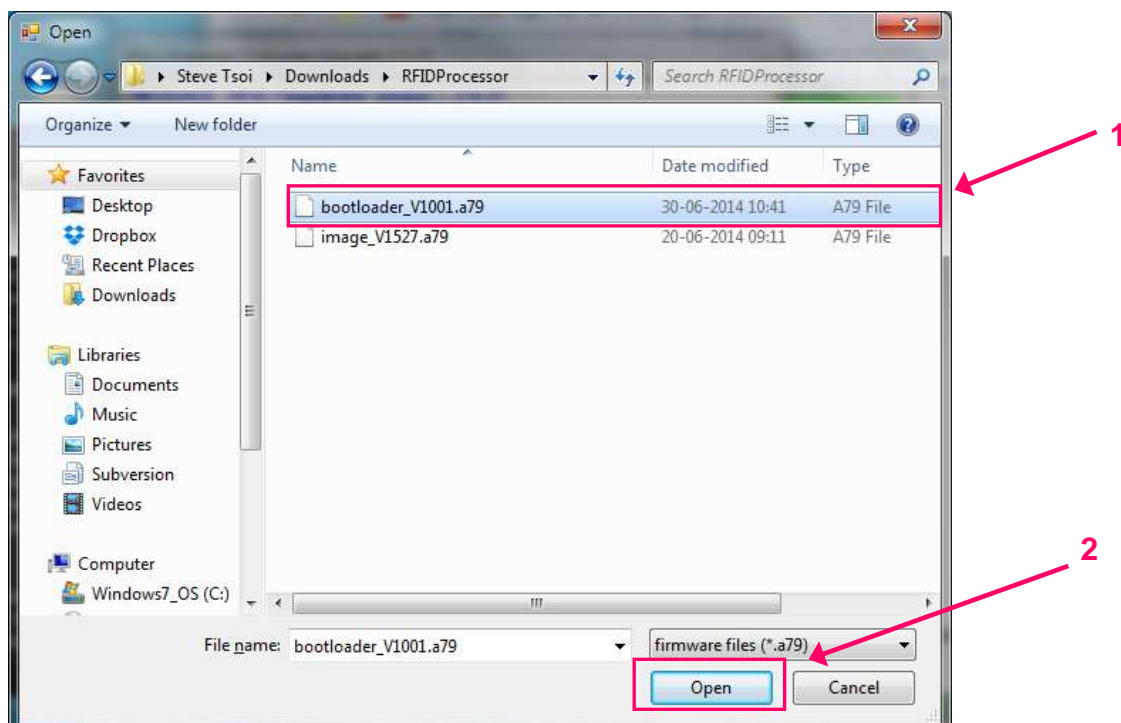

9. Press **[Start Update]** to start firmware update process.

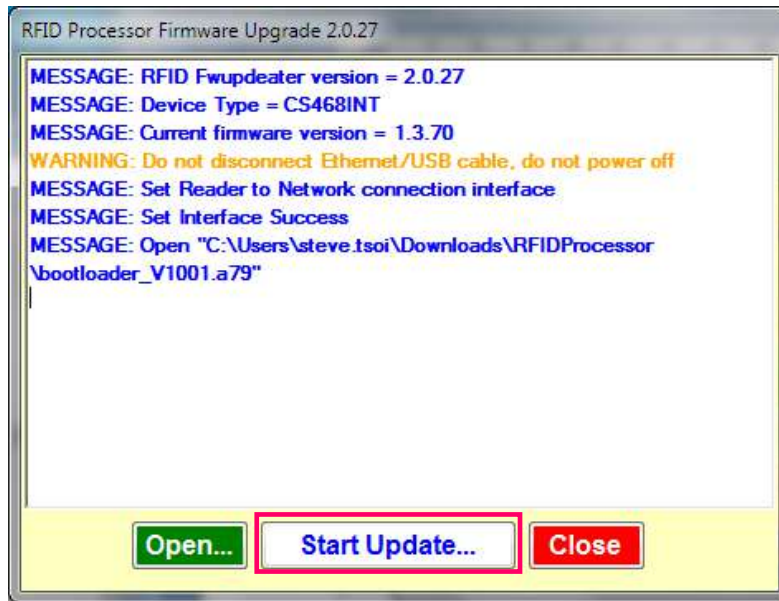

10. Wait until the firmware update process is finished.

**DO NOT unplug the reader during the process.**

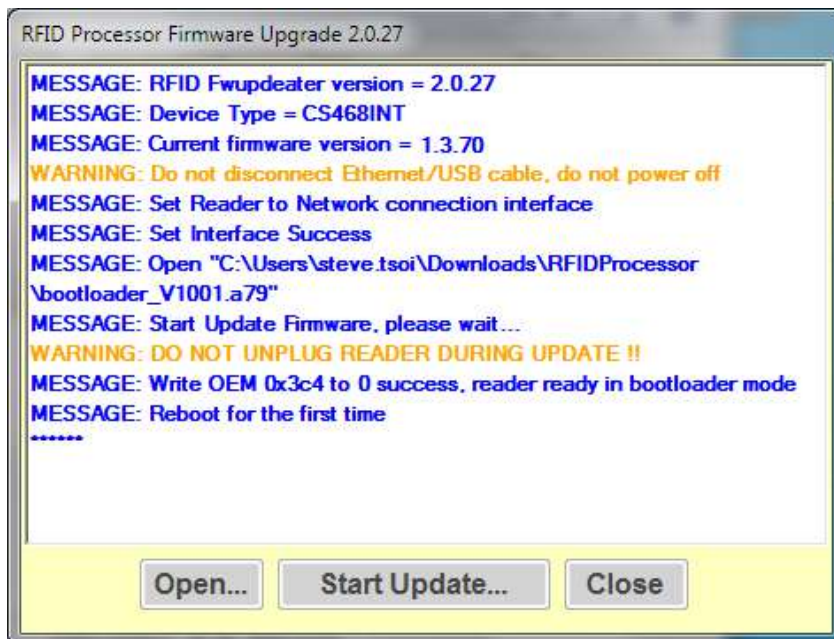

- At the end of the firmware update process, click **[Close]** to exit the Firmware Upgrade window.

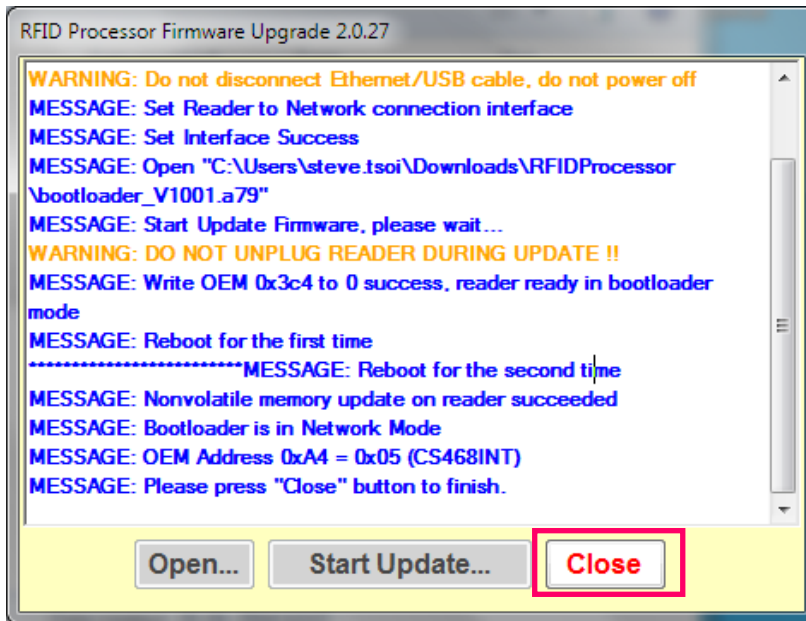

- Choose target device in the list. Click **[Connect]** to connect to the target reader.

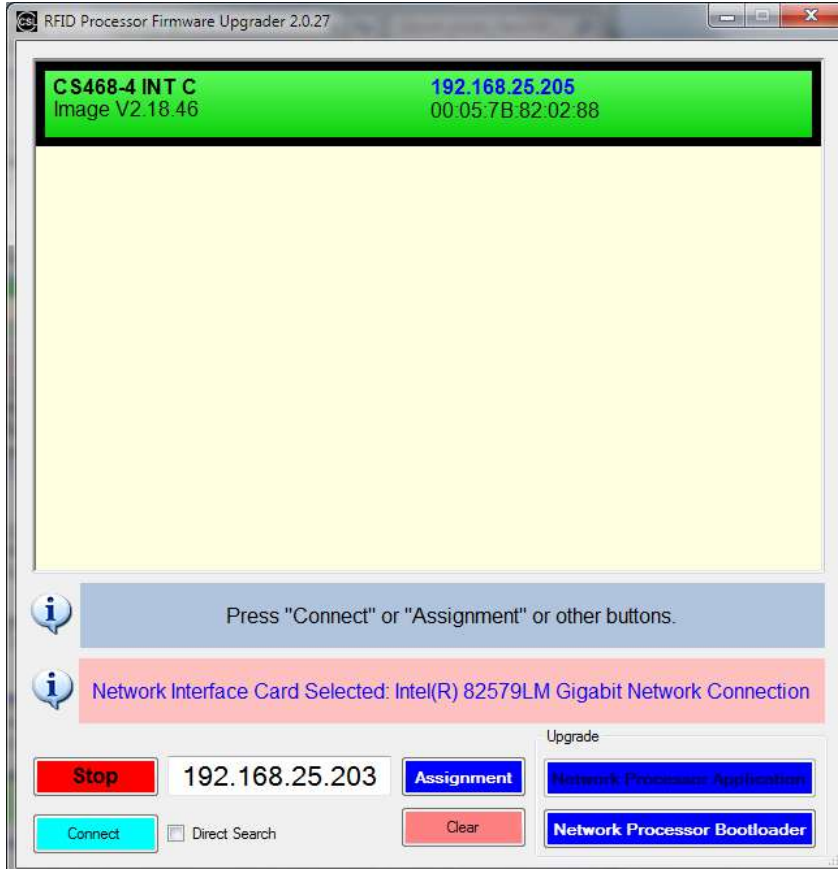

- Check the current version of the firmware. If Current firmware version = 1.0.01, the bootloader is successfully installed in previous steps.

To continue, click **[Open]**.

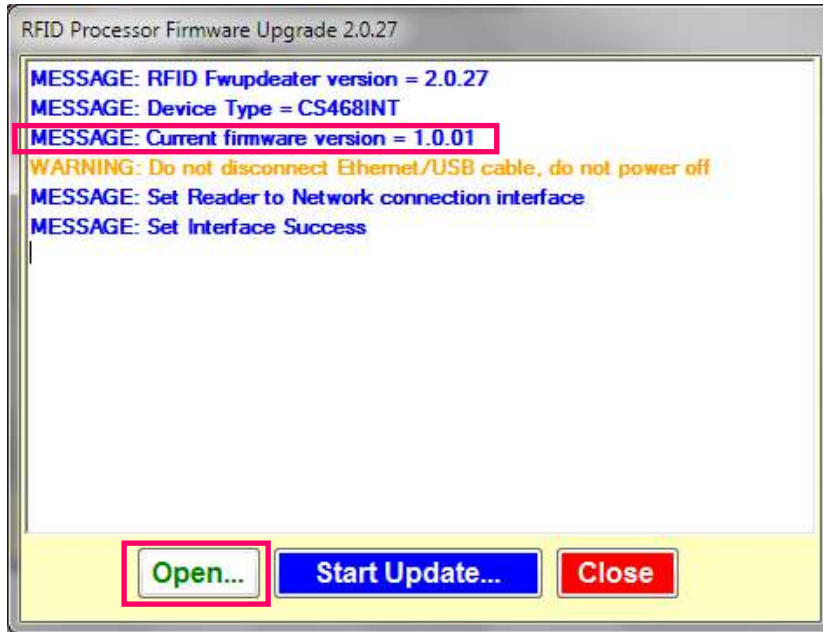

- Choose the latest RFID Processor application file.

Click **[Open]** to confirm.

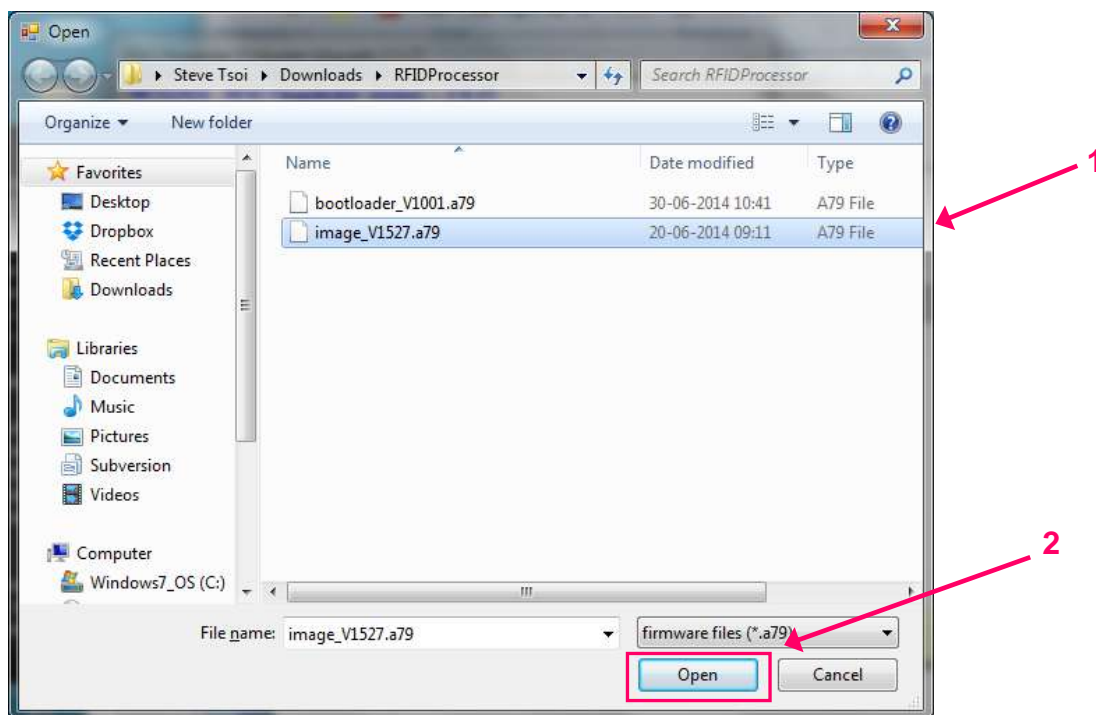



15. Press **[Start Update]** to start firmware upgrade process.

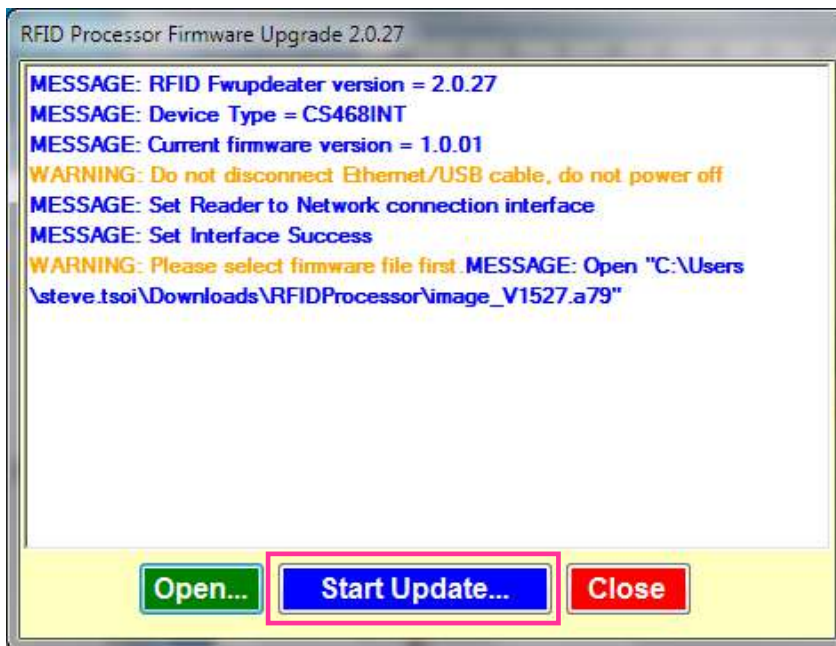

16. Wait until the firmware update process is finished.

**DO NOT unplug the reader during the process.**

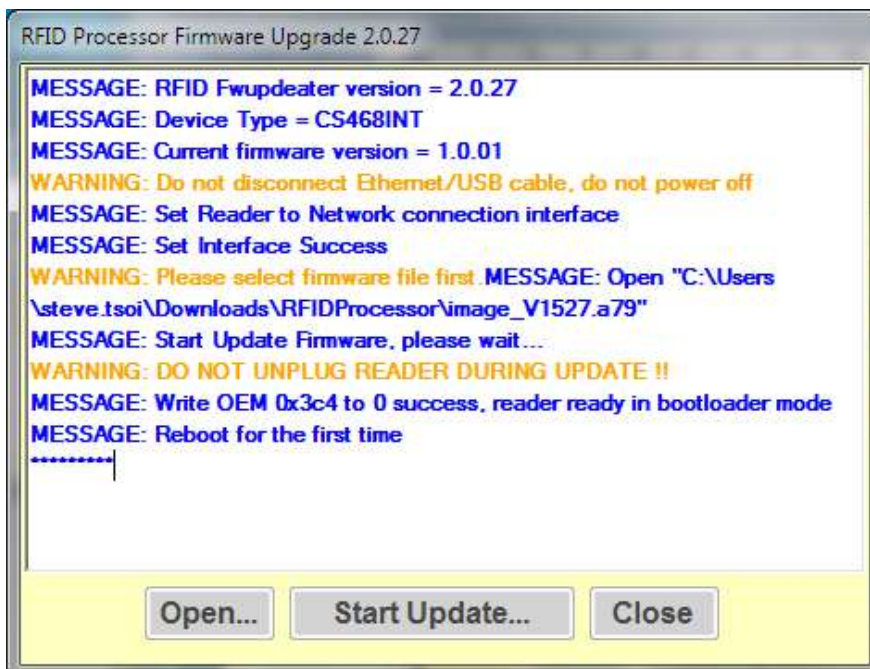

17. At the end of the firmware update process, click **[Close]** to exit the Firmware Upgrade window.

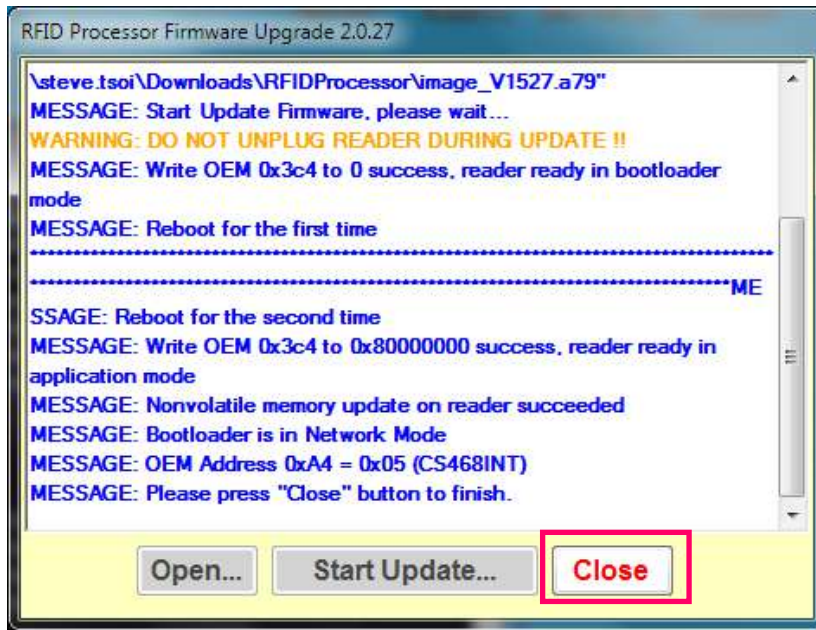

18. Quit **RFID FwUpgrade**.

19. Open **CSL C# Native Demo App**. The updated firmware version can be checked.



## 10.4.2 Procedure for CSL reader with RFID Processor App version 1.5.xx or after

1. User must check the RFID Firmware version before doing RFID Firmware upgrade. **If the RFID Firmware Vers is 1.3.xx and 1.4.xx, please refer to section “4.1 Procedure for CSL reader with RFID App version 1.3.xx and 1.4.xx )”.**

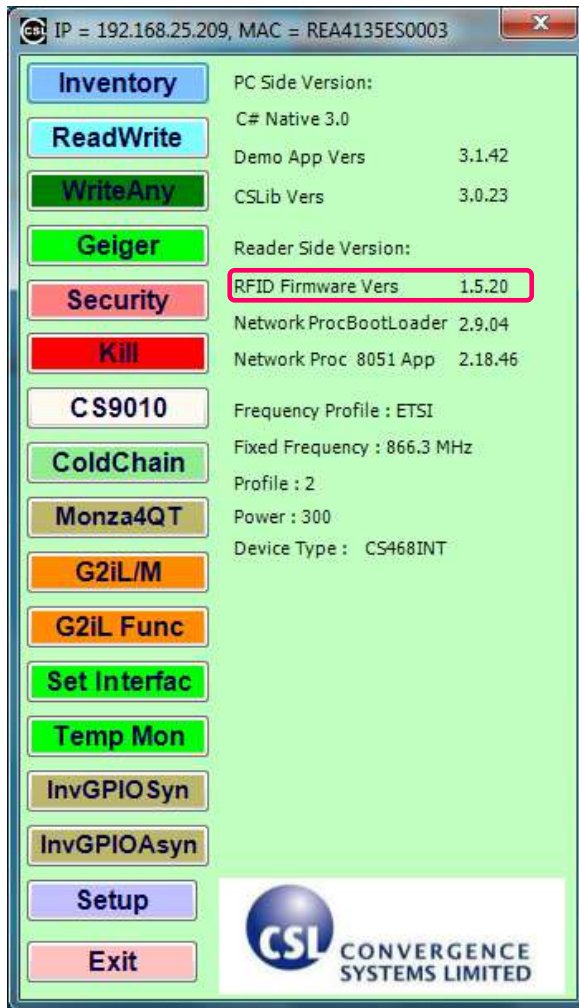

2. Please download the latest Firmware Upgrade tool from CSL website. The latest version is "RFID FwUpgrade2.0.27.zip".

- Download the latest bootloader and application file for RFID Processor from “Firmware - RFID Processor Bootloader” and “Firmware - RFID Processor Application”.

The screenshot shows the website interface for downloading firmware. The breadcrumb trail is: Home » Download & Support – Firmware – RFIDProcessor. The main heading is "Download & Support – Firmware – RFIDProcessor".

**Firmware – RFID Processor Bootloader**

File	Version	Note
<a href="#">bootloader_V1001.a79</a>	v1.0.1 (Latest)	Only need if your firmware is v1.3.xx or v1.4.xx

**Firmware – RFID Processor Application**

File	Version	Note
<a href="#">image_V1527.a79</a>	v1.5.27 (Latest)	Fix write error
<a href="#">image_V1526.a79</a>	v1.5.26	Add Ucode 7 parallel encoding
<a href="#">image_V1525.a79</a>	v1.5.25	

#### 4. Unzip "RFID FwUpgrade2.0.27.zip".

Run "RFID FwUpgrade.exe" for CSL reader is connected to PC via USB or Ethernet.

"RFID FwUpgrade\_Usb.exe" is used for CSL reader is connected to PC via USB only. Do not connect via Ethernet when using "RFID FwUpgrade\_Usb.exe"

"RFID FwUpgrade\_Net.exe" is used for CSL reader is connected to PC via Ethernet only. Do not connect via USB when using "RFID FwUpgrade\_Net.exe"

**Please run the exe file by double clicking the file within this directory only.**

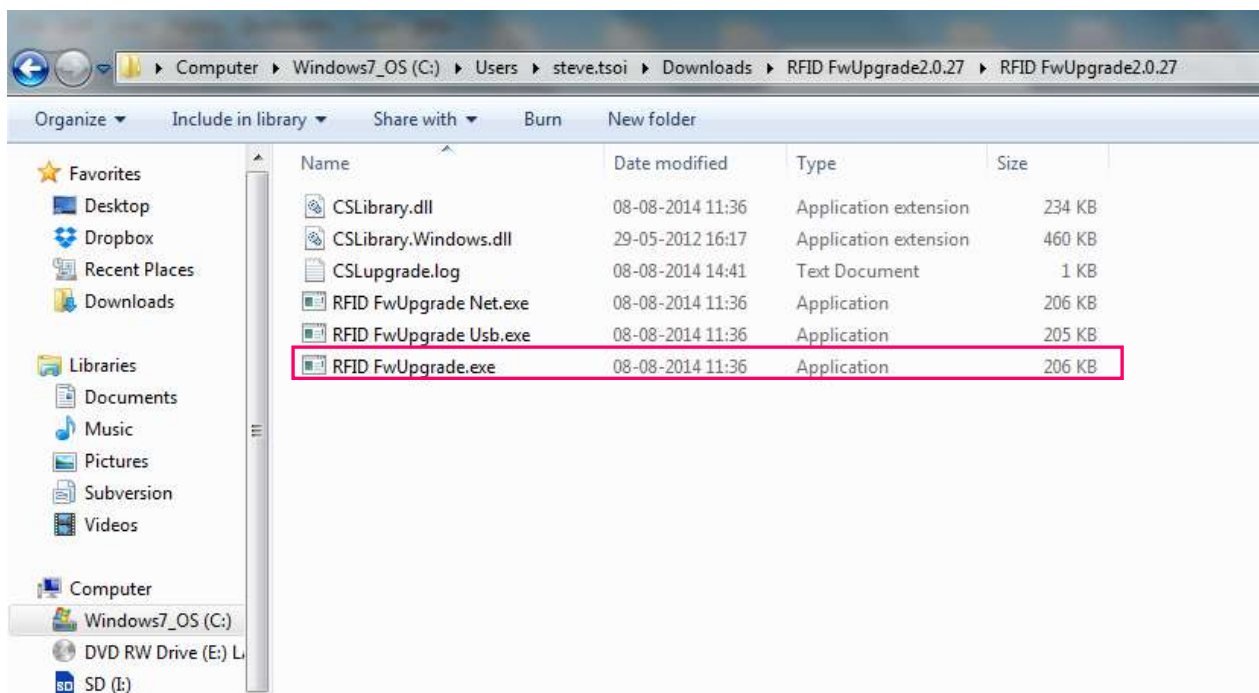

5. Click **Search** to check the target reader

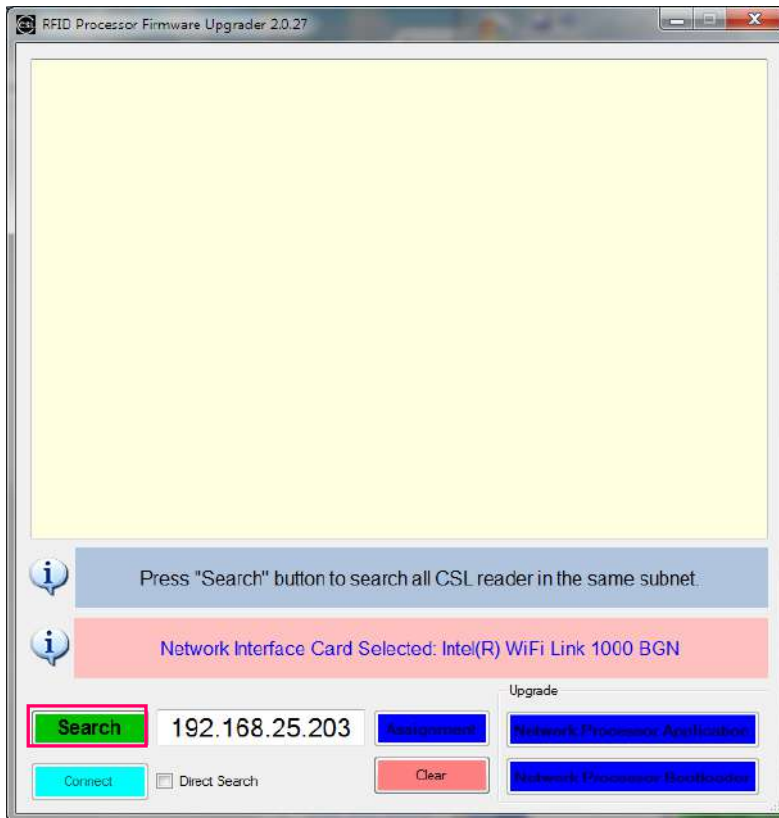

6. Choose target device in the list. Click [**Connect**] to connect to the target reader.

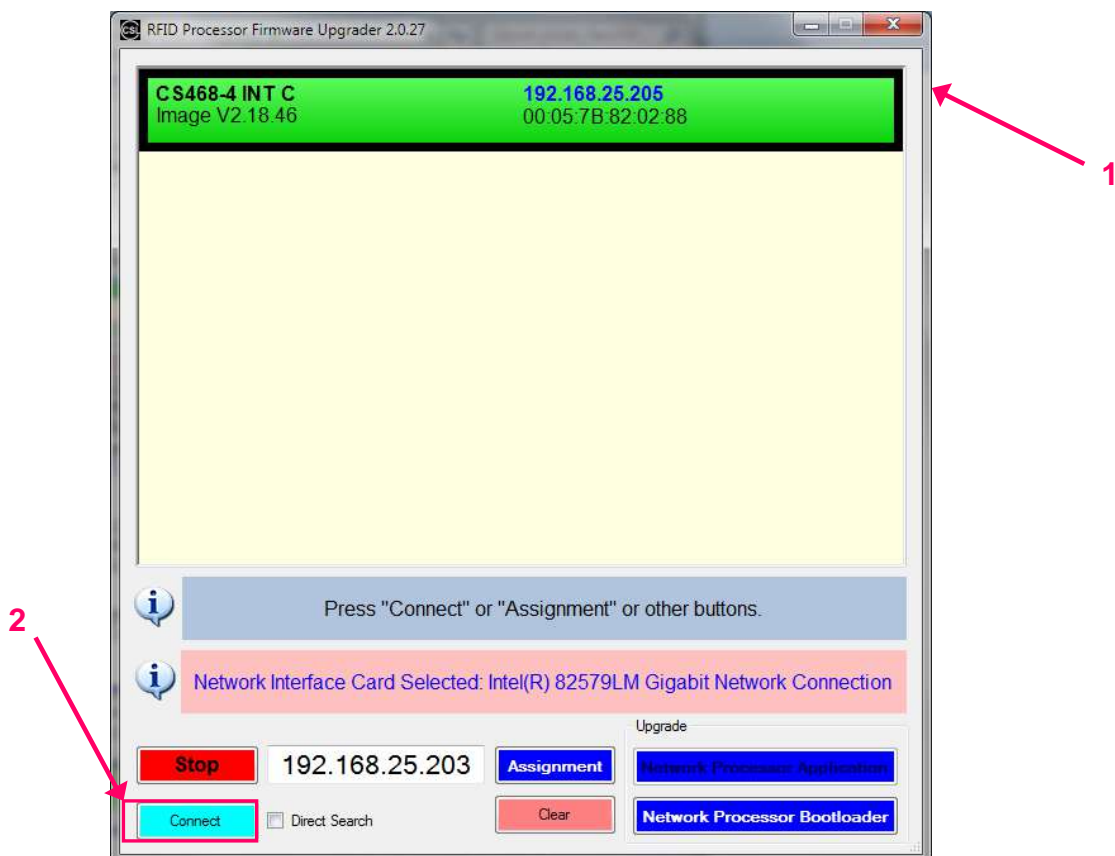

7. Check the current version of the firmware. Click **[Open]**.

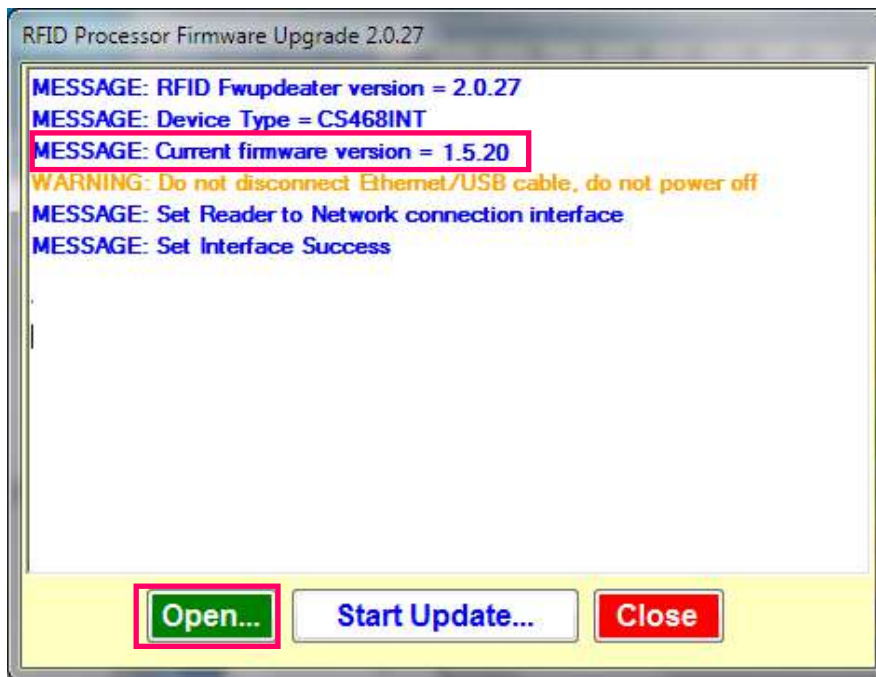

8. If current bootloader firmware version is v1.0.01, go to Step 14.

If current bootloader firmware version is v1.0.00, choose the RFID bootloader firmware file "bootloader\_V1001.a79".

Click **[Open]** to confirm.

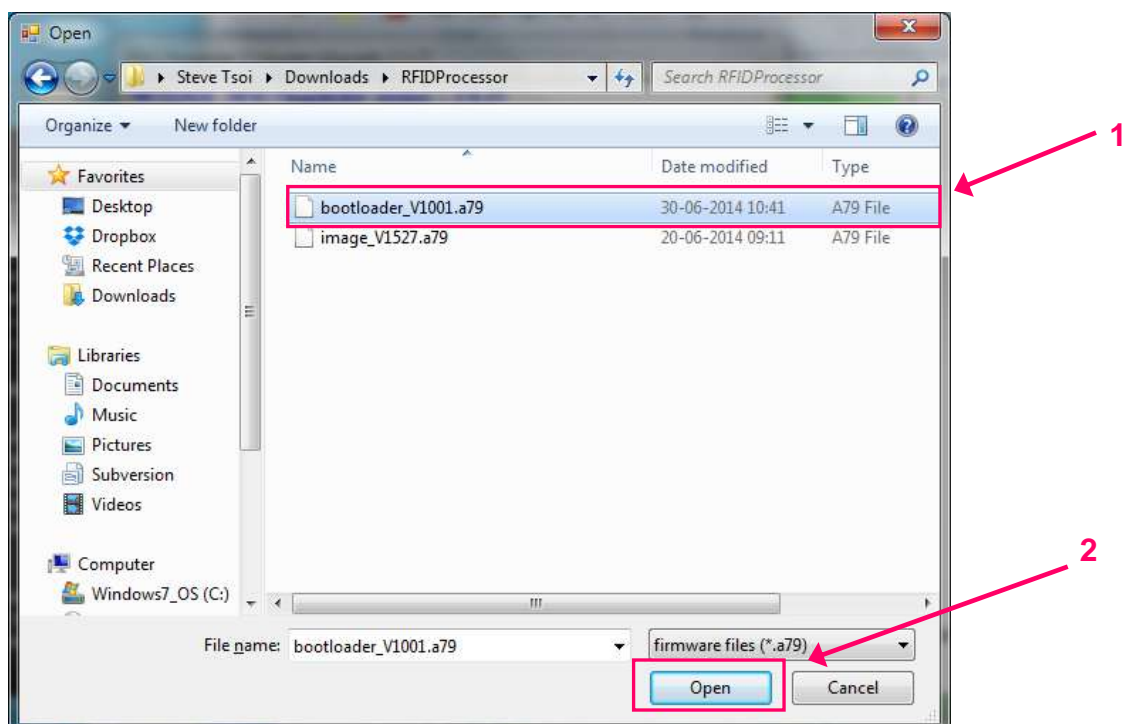

- Press **[Start Update]** to start firmware upgrade process.

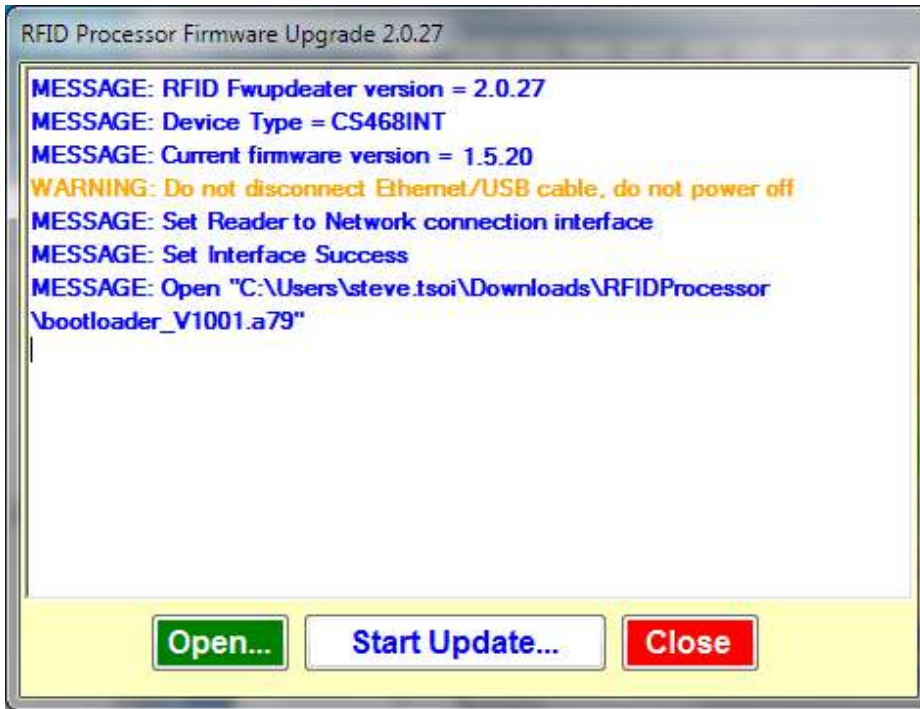

- Wait until the firmware update process is finished.

**DO NOT unplug the reader during the process.**

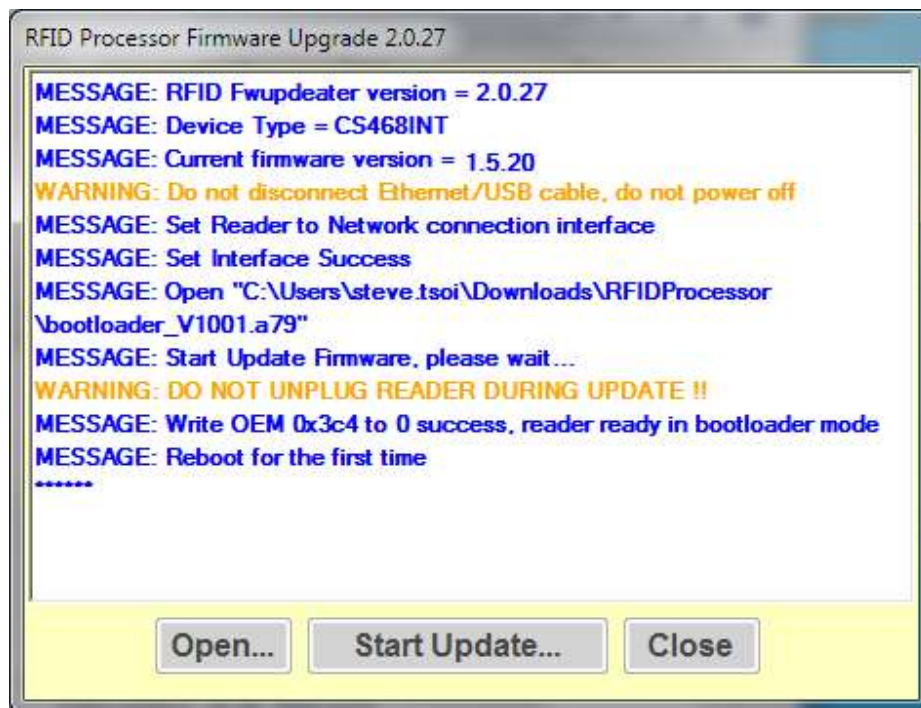



11. At the end of the firmware update process, click **[Close]** to exit the Firmware Upgrade window.

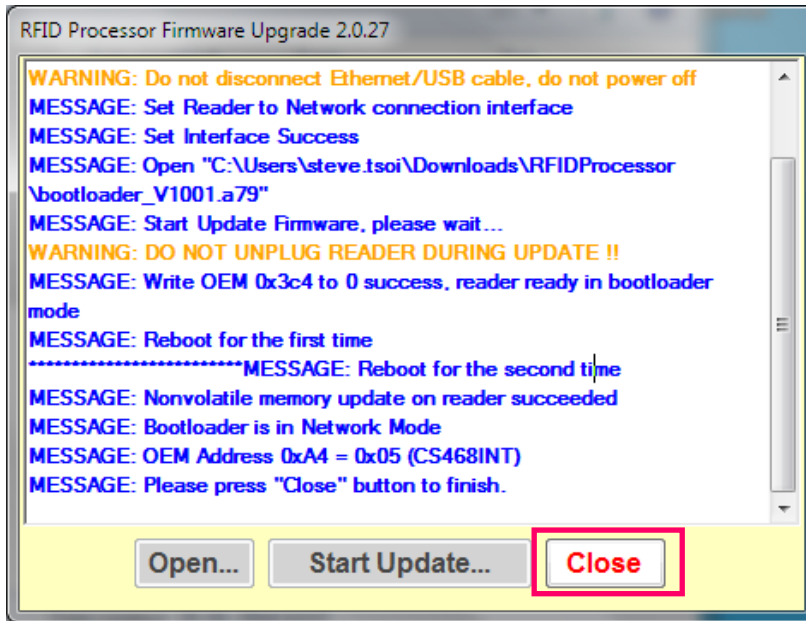

12. Choose target device in the list. Click **[Connect]** to connect to the target reader.

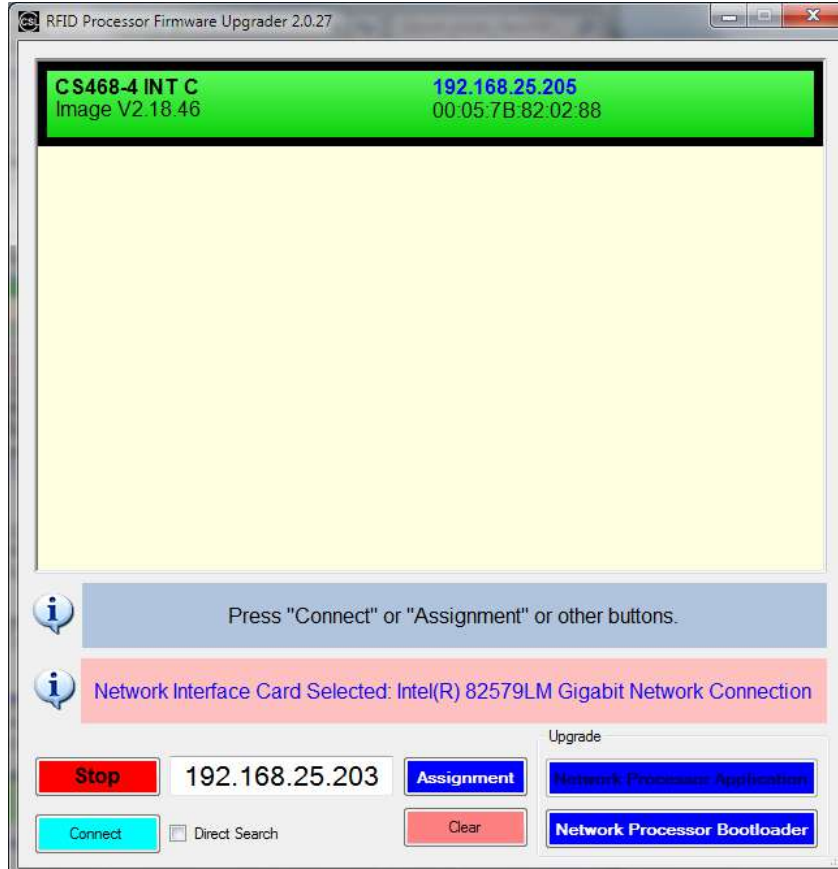

- Check the current version of the firmware. If Current firmware version = 1.0.01, the bootloader is successfully installed in previous steps.

To continue, click **[Open]**.

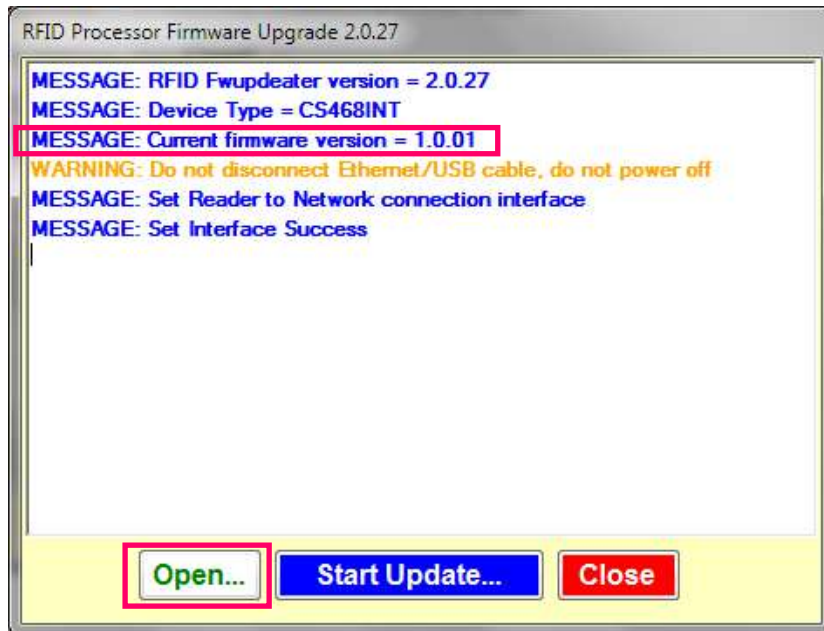

- Choose the latest RFID Processor application file.

Click **[Open]** to confirm.

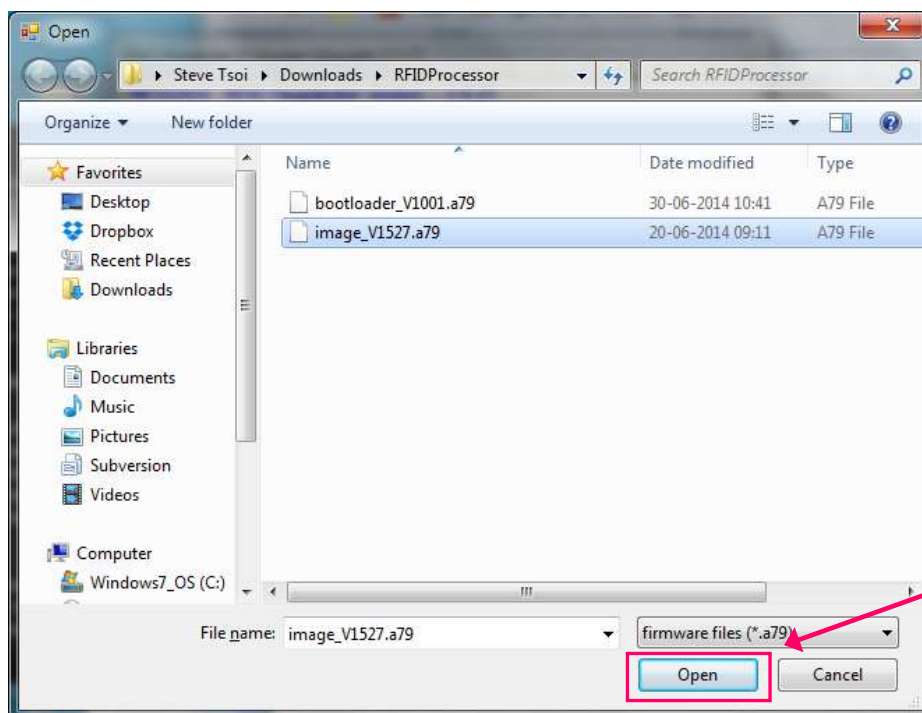

15. Press **[Start Update]** to start firmware upgrade process.

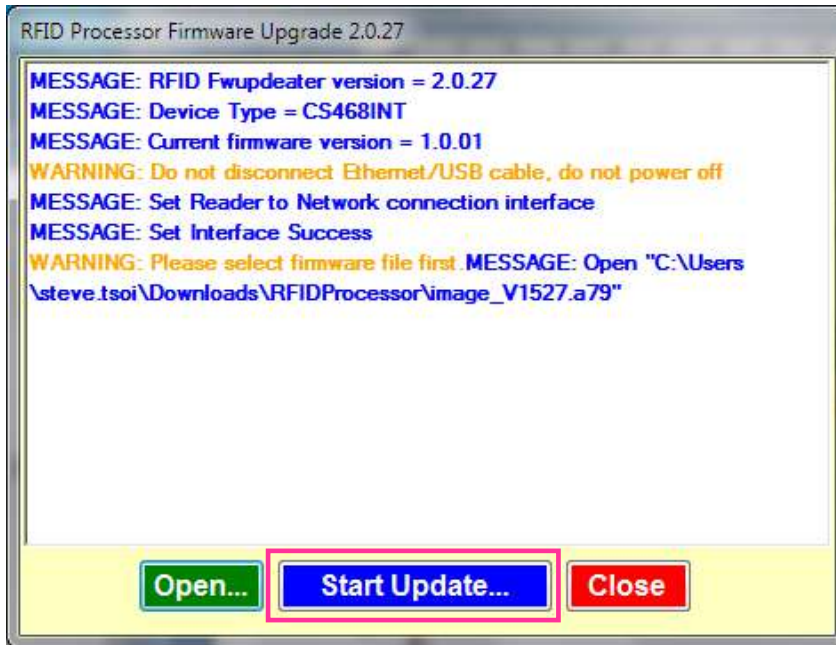

16. Wait until the firmware update process is finished.

**DO NOT unplug the reader during the process.**

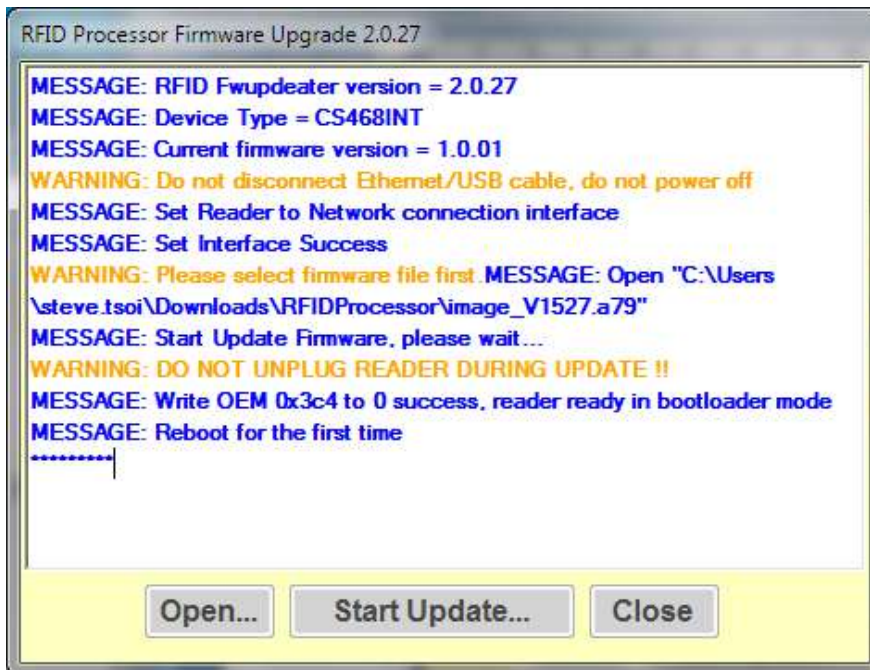

17. At the end of the firmware update process, click **[Close]** to exit the Firmware Upgrade window.

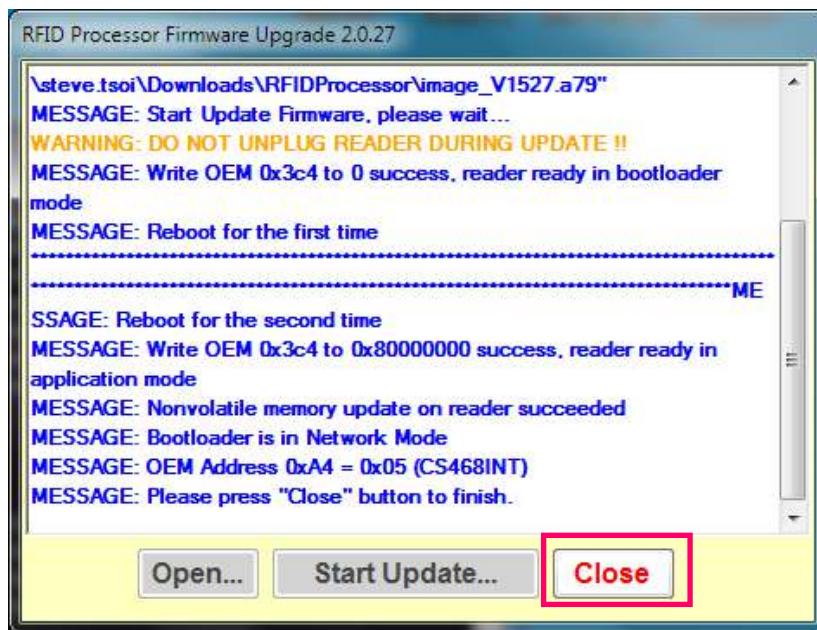

18. Quit **RFID FwUpgrade**.

19. Open **CSL C# Native Demo App**. The updated firmware version can be checked.

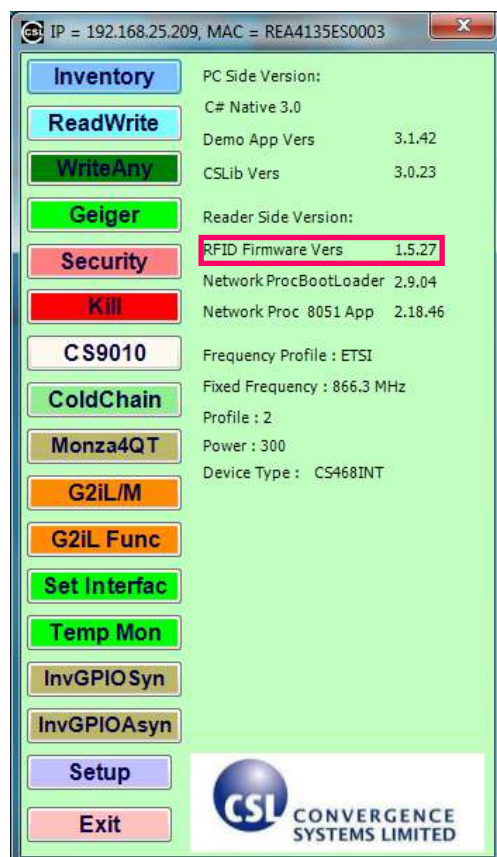

# 11 Regulatory Information

## 11.1 Federal Communications Commission (FCC)

### Compliance

This equipment has been tested and found to comply with the limits for a Class B digital device, pursuant to Part 15 of the FCC Rules. These limits are designed to provide reasonable protection against harmful interference in a residential installation. This equipment generates, uses and can radiate radio frequency energy and, if not installed and used in accordance with the instructions, may cause harmful interference to radio communications. However, there is no guarantee that interference will not occur in a particular installation. If this equipment does cause harmful interference to radio or television reception, which can be determined by turning the equipment off and on, the user is encouraged to try to correct the interference by one of the following measures:

- Reorient or relocate the receiving antenna.
- Increase the separation between the equipment and receiver.
- Connect the equipment into an outlet on a circuit different from that to which the receiver is connected.
- Consult the dealer or an experienced radio/TV technician for help.

**FCC Caution:** Any changes or modifications not expressly approved by the party responsible for compliance could void the user's authority to operate this equipment.

This device complies with Part 15 of the FCC Rules. Operation is subject to the following two conditions: (1) This device may not cause harmful interference, and (2) this device must accept any interference received, including interference that may cause undesired operation.

This equipment complies with FCC radiation exposure limits set forth for an uncontrolled environment. This equipment should be installed and operated with minimum distance 20cm between the radiator & your body.

This device and its antenna(s) must not be co-located or operating in conjunction with any other antenna or transmitter. This product must be installed by a professional technician/installer.

# Appendix A. RFID Basics

Passive tag RFID technology involves the reader, the antenna and the tag.

The reader sends out energy in the relevant frequency band to the antenna via RF cables, and the antenna radiates the energy out. This energy impinges on an RFID tag.

The RFID tag consists of an antenna coupled to an RFID IC. This IC converts the AC voltage it receives at the antenna port to DC voltage that in turn is used to empower the digital circuit inside.

The digital circuit then turns on and off some components connected to the antenna port, thereby changing its scattering behavior, in a pre-designed clock rate.

This changing of antenna port parameters then causes a “modulation” of the back-scattered RF energy.

This modulated back-scattered energy is detected by the reader and the modulation is captured and analyzed.

# Appendix B. Operation Profiles and Gen2 Parameters

## Link Profile

Different modulation profile can be selected by the user for different situation.

In CS203-3 (Japan) and CS203-1 (ETSI) readers, only profiles 0, 2, 3 and 5 are selectable.

The default setting is profile 2. It is also the recommended setting for most of the common applications.

Profile	0	1	2	3	4	5
R-T Modulation	DSB-ASK	DSB-ASK	PR-ASK	PR-ASK	DSB-ASK	PR-ASK
Tari (µs)	25.00	12.50	25.00	25.00	6.25	25.00
R-T speed (kbps)	40	80	40	40	160	40
PIE	2:1	2:1	1.5:1	1.5:1	1.5:1	1.5:1
Pulse Width (uS)	12.50	6.25	12.50	12.50	3.13	12.50
T-R LF (kbps)	40	160	250	300	400	250
T-R Modulation	FM0	Miller-2	Miller-4	Miller-4	FM0	Miller-2
Divide Ratio	8	8	64/3	64/3	8	64/3
T-R Data Rate (kbps)	40	80	62.5	75	400	125

## Q-Value

Q-value is a parameter that a reader uses to regulate the probability of Tag response. A reader commands Tags in an inventory round to load a Q-bit random (pseudo-random) number into their slot counter; the reader may also command Tags to decrement their slot counter. Tags reply when the value in their slot counter (i.e. their slot) is zero. Q is an integer in the range (0, 15); the corresponding Tag-response probabilities range from  $2^0 = 1$  to  $2^{-15} = 0.000031$ .

It is usually recommended to set a Q-value that have the corresponding number of slots larger than the exact maximum number of Tags to be read by the reader. For example, if there are 40 tags to be read by the reader, the Q-value is configured to 6, in which  $2^Q = 2^6 = 64 > 40$ .

In CS203, it consists of four main inventory algorithm (one fixed Q and three variable Q). The variable Q algorithms differ in their mechanism for adjusting the Q values at the end of each round. It also provides routines for the four tag access functions (read, write, kill and lock).

### 8) Fixed Q (Generic) Algorithm

- Fixed Q value
- Basis for all inventory algorithms.
- Optionally executes rounds until no tags are read.
- Optionally retries a rounds “n” times.
- Optionally flips A/B flag at end of round

This algorithm runs all inventory rounds with a single Q value. In this algorithm an inventory cycle consists of one or more rounds, each of which will attempt to read every slot. The number of slots to search is given by  $2Q$ . For example, a Q of 7 will cause the algorithm to search 128 slots on each round. One word of caution, if the time it takes to run the round is greater than the frequency hop time (and the session is 0) or antenna dwell time, the round will never complete.

### 9) Dynamic Q Algorithm (1)

- Q adjusts up or down at the end of each round.
- Executes repeated rounds until no tags are read when  $Q = Q$  minimum.
- Uses  $Q_{start}$ ,  $Q_{max}$  and  $Q_{min}$  parameters to control the range of Q.
- MaxReps to limit time spent at each Q value.
- HighThres and LowThres to control how Q will adjust.

In algorithm 1, the value of Q is dynamically adjusted based on the periodic evaluation of the relative frequency of RN16 timeouts vs EPC timeouts.

Each round is comprised of a Query and up to MaxReps queryReps.

The value of Q for the subsequent round is determined by the results of the current round. If the number of RN16 timeouts is greater than the number of EPC timeouts multiplied by  $thresHi$ , Q is decremented (presumed empty slots outnumber presumed collisions). If the number of RN16 timeouts is less than the number of EPC time outs times  $thresLo$ , Q is incremented (presumed collisions outnumber presumed empty slots). If the number of RN16 time outs falls between those two values, Q remains unchanged.

An inventory cycle is comprised of one or more inventory rounds, and is terminated when a round is executed with  $Q = 0$  and no tags read.

### 10) Dynamic Q Algorithm (2) – Dynamic Q Adjust

- Almost identical to algorithm 1.
- Same control interface as algorithm 1.
- Uses QueryAdjust command to modify Q value



Algorithm 2 is identical to algorithm 1 with the sole exception that a queryAdjust command is used to adjust the value of Q rather than a query command.

Read rate performance is increased relative to algorithm 1 because a) the query Adjust command is shorter, and b) new rounds are not initiated each time the value of Q changes, reducing the frequency of duplicate tag reads in the course of an inventory cycle.

Note though that algorithm 1 may deliver superior performance when reading small fast moving (or changing) tag populations due to the increased frequency with which query Commands are issued.

### 11) Dynamic Q Algorithm (3) – Dynamic Q Thresh

- New Q adjustment algorithm.
- Uses Qstart, Qmax and Qmin parameters to control the range of Q.
- QueryReps are not limited to a maximum number on a round.
- Single threshold multiplier used to control Q adjustment.
- QueryAdjust command used to modify Q value as in Algorithm 2.

In algorithm 3, the value of Q is adjusted based on the continuous evaluation of the relative frequency of RN16 timeouts vs EPC timeouts.

An inventory cycle consists of a single round initiated by a Query command.

Following the query command, up to  $(2^Q - 1)$  queryRep commands are issued.

If in the course of operation the number RN16 timeouts exceeds the adjusted number of EPC timeouts by a calculated threshold, the value of Q is decremented (presumed empty slots outnumber presumed collisions). If the adjusted number of EPC timeouts exceeds the number of RN16 timeouts by a calculated threshold, the value of Q is incremented (presumed collisions outnumber presumed empty slots). While the relative number of RN16 time outs vs the adjusted number of EPC time outs falls within the threshold, Q is unchanged.

When the value of Q changes, or if all slots under the current Q value have been inventoried, the slot counters of the participating tag population is refreshed using a queryAdjust command.

The calculated threshold equals the current value of Q times a multiplier (set by default to 1).

The EPC timeout count is adjusted by Rtot, the ratio of (EPC timeout / RN16 timeout).

An inventory cycle is terminated when all slots have been checked with  $Q = Q_{min}$  and no tags have been read.

Read rate performance is increased relative to algorithm 2 because a) Q remains unchanged while well matched to the population, b) Q value is changed more quickly when it is not well matched, and c) on the average, fewer queryAdjust commands are issued.

**Session**

An inventory process comprising a reader and an associated Tag population. A reader chooses one of four sessions and inventories Tags within that session. The reader and associated Tag population operate in one and only one session for the duration of an inventory round. For each session, Tags maintain a corresponding inventoried flag. Sessions allow Tags to keep track of their inventoried status separately for each of four possible time-interleaved inventory processes, using an independent inventoried flag for each process.

**Inventories flag (Flag)**

A flag that indicates whether a Tag may respond to a reader. Tags maintain a separate inventoried flag for each of four sessions; each flag has symmetric A and B values. Within any given session, reader typically inventory Tags from A to B followed by a re-inventory of Tags from B back to A (or vice versa).

# Appendix C. RF channels

Region	Frequency Range (MHz)	# of channels	Channels (MHz)
Australia (AU)	920 – 926	10	920.75, 921.25, 921.75, 922.25, 922.75, 923.25, 923.75, 924.25, 924.75, 925.25,
Brazil 1 (BR1)	915 – 928	24	915.75, 916.25, 916.75, 917.25, 917.75, 918.25, 918.75, 919.25, 919.75, 920.25, 920.75, 921.25, 921.75, 922.25, 922.75, 923.25, 923.75, 924.25, 924.75, 925.25, 925.75, 926.25, 926.75, 927.25,
Brazil 2 (BR2)	902 – 907 915 – 928	33	902.75, 903.25, 903.75, 904.25, 904.75, 905.25, 905.75, 906.25, 906.75, 915.75, 916.25, 916.75, 917.25, 917.75, 918.25, 918.75, 919.25, 919.75, 920.25, 920.75, 921.25, 921.75, 922.25, 922.75, 923.25, 923.75, 924.25, 924.75, 925.25, 925.75, 926.25, 926.75, 927.25,
China (CN)	920 – 925	10	920.625, 920.875, 921.125, 921.375, 921.625, 921.875, 922.125, 922.375, 922.625, 922.875, 923.125, 923.375, 923.625, 923.875, 924.125, 924.375,
ETSI, G800	865 – 868	4	865.70, 866.30, 866.90, 867.50,
Hong Kong (HK) Singapore (SG)	920 – 925	8	920.75, 921.25, 921.75, 922.25, 922.75, 923.25, 923.75, 924.25,
India (IN)	865 – 868	3	865.70, 866.30, 866.90,
Japan (JP)	952 – 954	7	952.40, 952.60, 952.80, 953.00, 953.20, 953.40, 953.60,
Korea (KR)	910 – 914	19	910.20, 910.40, 910.60, 910.80, 911.00, 911.20, 911.40, 911.60, 911.80, 912.00, 912.20, 912.40, 912.60, 912.80, 913.00, 913.20, 913.40, 913.60, 913.80,
Malaysia (MY)	919 – 924	8	919.75, 920.25, 920.75, 921.25, 921.75, 922.25, 922.75, 923.25,
South Africa (ZA)	915 – 919	16	915.7, 915.9, 916.1, 916.3, 916.5, 916.7, 916.9, 917.1, 917.3, 917.5, 917.7, 917.9,

			918.1, 918.3, 918.5, 918.7,
Taiwan (TW)	922 – 928	12	922.25, 922.75, 923.25, 923.75, 924.25, 924.75, 925.25, 925.75, 926.25, 926.75, 927.25, 927.75,
USA (FCC)	902 – 928	50	902.75, 903.25, 903.75, 904.25, 904.75, 905.25, 905.75, 906.25, 906.75, 907.25, 907.75, 908.25, 908.75, 909.25, 909.75, 910.25, 910.75, 911.25, 911.75, 912.25, 912.75, 913.25, 913.75, 914.25, 914.75, 915.25, 915.75, 916.25, 916.75, 917.25, 917.75, 918.25, 918.75, 919.25, 919.75, 920.25, 920.75, 921.25, 921.75, 922.25, 922.75, 923.25, 923.75, 924.25, 924.75, 925.25, 925.75, 926.25, 926.75, 927.25

## Appendix D. Common Mistakes

1. The weatherproof Ethernet cable that comes with the product package is a "CROSSOVER" cable. If user wants to connect on a switch/router, it may or may not work depending on whether the network port on the switch/router can handle a crossover cable. Newer switch/router have Ethernet card capable of "Auto-Detect" and "Auto-Switch" (Auto-MDI/MDIX). Older switches may not be capable of that. So for older switches, one has to use an Ethernet Crossover Adaptor. This is a small adaptor with Ethernet socket on both ends. This will cross switch the cable.
2. The CS203 comes ex-factory with a standard IP address (192.168.25.203). When the user first opens the unit from the box, the user must use a laptop with an IP address in the same subnet (192.168.25.x) to connect to the CS203. The user can also use the DEMO APP program to search for the CS203 and figure out its IP address. Once connected, then the user can change the IP address on the CS203. Once that is done, the CS203 can be deployed in the actual site.
3. If you need to connect the CS203 to a router/switch and use the Power-over-Ethernet (PoE) function of CS203, make sure that the router/switch you use is PoE-enabled.
4. When you use the CS203 Demo Application Program, make sure that the port number 1515 and 1516 are opened (or turn off any firewall on the network). These 2 ports are used for the auto-discovery of the readers in the network.

# Appendix E. Technical Support

System integrators setting up the CSL CS203 Integrated Reader may encounter some problems. To quickly solve that, they are welcome to send the symptoms and configuration files back to [techsupport@convergence.com.hk](mailto:techsupport@convergence.com.hk) for support. Please send the following:

- 1) CS203 Factory Serial Number - best to take a photo of the label at the back of the reader and send the photo to CSL technical support team
- 2) Final firmware versions of reader
- 3) Final library version on PC side
- 4) Brief description of problems
- 5) Screen capture of problems or error messages on PC with time
- 6) Screen capture of command window doing "netstat -na" command
- 7) Screen capture of command window doing "ipconfig" command
- 8) Screen capture of Windows Task Manager "Processes" window
- 9) Screen capture of Windows Task Manager "Applications" window
- 10) Screen capture of Windows Task Manager "Performance" window
- 11) Photos of the overall site (if that can be released)

Send the above sets of data to [techsupport@convergence.com.hk](mailto:techsupport@convergence.com.hk)